

Heathkit[®]

Heathkit[®]

for the

**REMOTE COAX
SWITCH**

Model HD-1481

595-3189-04

kit[®]

kit[®]

Heathkit[®]

Heathkit[®]

Heathkit[®]

Heathkit[®]

HEATH COMPANY PHONE DIRECTORY

The following telephone numbers are direct lines to the departments listed:

Kit orders and delivery information 616-982-3411
Credit 616-982-3561
Replacement Parts 616-982-3571

Technical Assistance Phone Numbers
(8:00 A.M. to 4:30 P.M. Eastern Time, Weekdays Only)

Education Products 616-982-3980
Amateur Radio 616-982-3296
Test Equipment, Weather Instruments,
Clocks 616-982-3315
Television 616-982-3307
Home Products, Stereo, Security, Telephone,
Marine, Automotive 616-982-3496
Computer — Hardware 616-982-3309

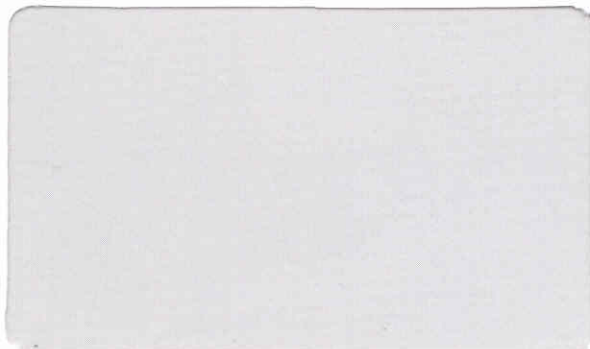

YOUR HEATHKIT 1 YEAR LIMITED WARRANTY

Consumer Protection Plan for Heathkit Consumer Products

Welcome to the Heath family. We believe you will enjoy assembling your kit and will be pleased with its performance. Please read this Consumer Protection Plan carefully. It is a "LIMITED WARRANTY" as defined in the U.S. Consumer Product Warranty and Federal Trade Commission Improvement Act. This warranty gives you specific legal rights, and you may also have other rights which vary from state to state.

Heath's Responsibility

PARTS — Replacements for factory defective parts will be supplied free for 1 year from date of purchase. Replacement parts are warranted for the remaining portion of the original warranty period. You can obtain warranty parts direct from Heath Company by writing or telephoning us at (616) 982-3571. And we will pay shipping charges to get those parts to you ... anywhere in the world.

SERVICE LABOR — For a period of 1 year from the date of purchase, any malfunction caused by defective parts or materials will be corrected at no charge to you. You must deliver the unit at your expense to the Heath factory, any Heath/Zenith Computers and Electronics center (units of Veritechnology Electronics Corporation), or any of our authorized overseas distributors.

TECHNICAL CONSULTATION — You will receive free consultation on any problem you might encounter in the assembly or use of our Heathkit product. Just drop us a line or give us a call. Sorry, we cannot accept collect calls.

NOT COVERED — The correction of assembly errors, adjustments, calibration, and damage due to misuse, abuse, or negligence are not covered by the warranty. Use of corrosive solder and/or the unauthorized modification of the product or of any furnished component will void this warranty in its entirety. This warranty does not include reimbursement for inconvenience, loss of use, customer assembly, set-up time, or unauthorized service.

This warranty covers only Heath products and is not extended to other equipment or components that a customer uses in conjunction with our products.

SUCH REPAIR AND REPLACEMENT SHALL BE THE SOLE REMEDY OF THE CUSTOMER AND THERE SHALL BE NO LIABILITY ON THE PART OF HEATH FOR ANY SPECIAL, INDIRECT, INCIDENTAL OR CONSEQUENTIAL DAMAGES, INCLUDING BUT NOT LIMITED TO ANY LOSS OF BUSINESS OR PROFITS, WHETHER OR NOT FORESEEABLE.

Some states do not allow the exclusion or limitation of incidental or consequential damages, so the above limitation or exclusion may not apply to you.

Owner's Responsibility

EFFECTIVE WARRANTY DATE — Warranty begins on the date of first consumer purchase. You must supply a copy of your proof of purchase when you request warranty service or parts.

ASSEMBLY — Before seeking warranty service, you should complete the assembly by carefully following the manual instructions. Heathkit service agencies cannot complete assembly and adjustments that are customer's responsibility.

ACCESSORY EQUIPMENT — Performance malfunctions involving other non-Heath accessory equipment (antennas, audio components, computer peripherals and software, etc.) are not covered by this warranty and are the owner's responsibility.

SHIPPING UNITS — Follow the packing instructions published in the assembly manuals. Damage due to inadequate packing cannot be repaired under warranty.

If you are not satisfied with our service (warranty or otherwise) or our products, write to our Director of Customer Service, Heath Company, Benton Harbor MI 49022. He will make certain your problems receive immediate, personal attention.

Heathkit® Manual

for the

REMOTE COAX SWITCH

Model HD-1481

595-3189-04

WARNING: TO PREVENT FIRE OR SHOCK HAZARD, DO NOT EXPOSE THE CONTROL CHASSIS TO RAIN OR MOISTURE.

HEATH COMPANY
BENTON HARBOR, MICHIGAN 49022

Copyright © 1984
Heath Company
All Rights Reserved
Printed in the United States of America

TABLE OF CONTENTS

INTRODUCTION	3	IN CASE OF DIFFICULTY	28
ASSEMBLY NOTES	4	Troubleshooting Chart	29
PARTS LIST	8	SPECIFICATIONS	30
STEP-BY-STEP ASSEMBLY	10	CIRCUIT DESCRIPTION	31
Circuit Board	10	SEMICONDUCTOR	
Remote Unit	14	IDENTIFICATION CHART	32
Control Unit	15	CIRCUIT BOARD X-RAY VIEW	33
INITIAL TESTS	23	SCHEMATIC	(Illustration Booklet, Page 7)
FINAL ASSEMBLY	25	WARRANTY	Inside front cover
INSTALLATION	26	CUSTOMER SERVICE	Inside rear cover
OPERATION	27		



INTRODUCTION

The Heathkit Model HD-1481 Remote Coax Switch, which will operate efficiently from 1.8 to 54 MHz, is a tower- or mast-mounted RF coaxial switch that you can conveniently control from inside your house.

An advantage of this remotely controlled coax switch is that you only need one feedline to operate up to four antennas. With a manual coax switch, on the other hand, you would need one feedline for each of your antennas.

The Remote Coax Switch consists of two units – an outdoor switching network, called “the remote unit,” and an indoor control unit. These two units are interconnected by a single length of coaxial cable, thereby eliminating the need for any multi-conductor control cable.

The remote unit is rain tight and contains the RF switches that allow you to select the desired antenna. You can mount the remote unit with a single clamp. The remote chassis extends over the connector area to provide weather protection.

The control unit contains the power supply and provides the switching voltages to the remote unit. A front-panel-mounted switch selects the desired antenna.

This simple and ruggedly designed Remote Coax Switch will give you years of convenient, trouble-free operation.

ASSEMBLY NOTES

TOOLS

You will need these tools to assemble your kit.

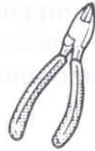
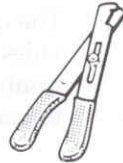
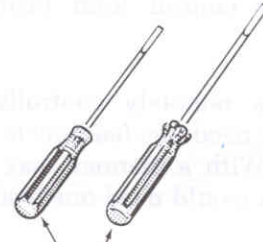
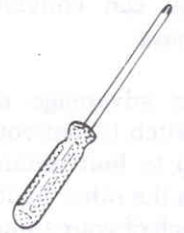

PLIERS

LONG-NOSE
PLIERSDIAGONAL
CUTTERSWIRE
STRIPPERS1/8" & 1/4"-BLADE
SCREWDRIVERSPHILLIPS
SCREWDRIVER

OTHER HELPFUL TOOLS

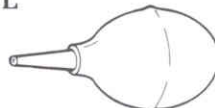
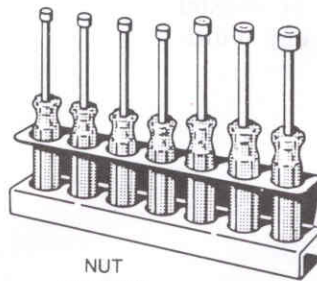
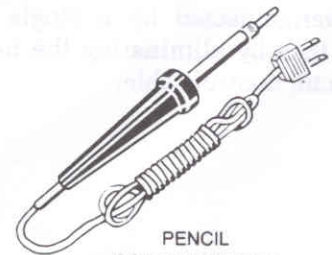
NUT STARTER
(May Be Supplied
With Kit)DESOLDERING
BULB*DESOLDERING
BRAID*NUT
DRIVERSPENCIL
SOLDERING IRON
(22 to 25 WATTS)

*To Remove Solder From Circuit Connections.

ASSEMBLY

1. Follow the instructions carefully. Read the entire step before you perform each operation.
2. The illustrations in the Manual are called Pictorials and Details. Pictorials show the overall operation for a group of assembly steps; Details generally illustrate a single step. When you are directed to refer to a certain Pictorial "for the following steps," continue using that Pictorial until you are referred to another Pictorial for another group of steps.
3. Most kits use a separate "Illustration Booklet" that contains illustrations (Pictorials, Details, etc.) that are too large for the Assembly Manual. Keep the "Illustration Booklet" with the Assembly Manual. The illustrations in it are arranged in Pictorial number sequence.
4. Position all parts as shown in the Pictorials.
5. Solder a part or a group of parts only when you are instructed to do so.

6. Each circuit part in an electronic kit has its own component number (R2, C4, etc.). Use these numbers when you want to identify the same part in the various sections of the Manual. These numbers, which are especially useful if a part has to be replaced, appear:
- In the Parts List,
 - At the beginning of each step where a component is installed,
 - In some illustrations,
 - In Troubleshooting Charts,
 - In the Schematic,
 - In the sections at the rear of the Manual.
7. When you are instructed to cut something to a particular length, use the scales (rulers) provided at the bottom of the Manual pages.

SAFETY WARNING: Avoid eye injury when you cut off excessive lead lengths. Hold the leads so they cannot fly toward your eyes.

SOLDERING

Soldering is one of the most important operations you will perform while assembling your kit. A good solder connection will form an electrical connection between two parts, such as a component lead and a circuit board foil. A bad solder connection could prevent an otherwise well-assembled kit from operating properly.

It is easy to make a good solder connection if you follow a few simple rules:

1. Use the right type of soldering iron. A 22 to 25-watt pencil soldering iron with a 1/8" or 3/16" chisel or pyramid tip works best.
2. Keep the soldering iron tip clean. Wipe it often on a wet sponge or cloth; then apply solder to the tip to give the entire tip a wet look. This process is called tinning, and it will protect the tip and enable you to make good connections. When solder tends to "ball" or does not stick to the tip, the tip needs to be cleaned and retinned.

NOTE: Always use rosin core, radio-type solder (60:40 tin-lead content) for all of the soldering in this kit. This is the type we have supplied with the parts. The Warranty will be void and we will not service any kit in which acid core solder or paste has been used.

RESISTORS

Resistors are identified in Parts Lists and steps by their resistance value in Ω (ohms), $k\Omega$ (kilohms), or $M\Omega$ (megohms). They are usually identified by a color code of four or five color bands, where each color represents a number. See the "Resistor Color Code" chart. These colors are given in the steps in their proper order (except for the last band, which indicates a resistor's "tolerance"; see the "Resistor Tolerance Chart"). You do not need to memorize the color codes.

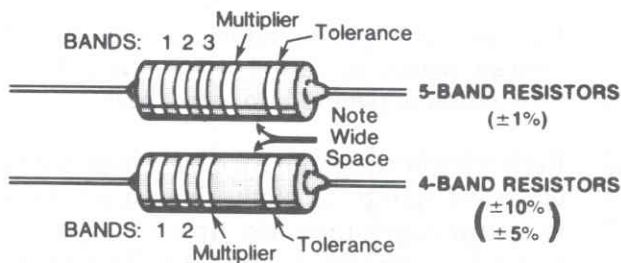

Occasionally, a "precision" or "power" resistor may have the value stamped on it. The letter R, K, or M may also be used at times to signify a decimal point, as in:

2R2 = 2.2 Ω
 2K2 = 2.2 $k\Omega$, or 2200 Ω
 2M2 = 2.2 $M\Omega$

Precision resistors may also be marked as shown in the following examples. The values of the multipliers are shown in the "Multiplier Chart," and the tolerance values are shown in the "Resistor Tolerance" chart.

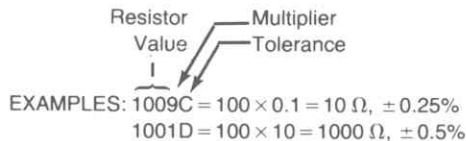

CAPACITORS

Capacitors will be called out by their capacitance value in μF (microfarads) or pF (picofarads) and type: ceramic, Mylar®, electrolytic, etc. Some capacitors may have their value printed in the following manner:

First and second digits of capacitor's value: 15

Multiplier: Multiply the first & second digits by the proper value from the "Multiplier Chart."

To find the tolerance of the capacitor, look up this letter in the capacitor Tolerance chart.

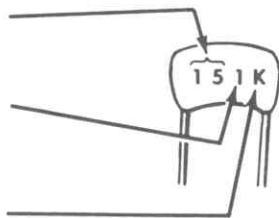

RESISTOR COLOR CODE CHART

	Band 1	Band 2	Band 3 (if used)	Multiplier
Color	1st Digit	2nd Digit	3rd Digit	
Black	0	0	0	1
Brown	1	1	1	10
Red	2	2	2	100
Orange	3	3	3	1,000
Yellow	4	4	4	10,000
Green	5	5	5	100,000
Blue	6	6	6	1,000,000
Violet	7	7	7	10,000,000
Gray	8	8	8	100,000,000
White	9	9	9	—
Silver	—	—	—	.01
Gold	—	—	—	.1

RESISTOR TOLERANCE CHART

	COLOR OR LETTER	
$\pm 10\%$	SILVER	
$\pm 5\%$	GOLD	J
$\pm 2\%$	RED	G
$\pm 1\%$	BROWN	F
$\pm 0.5\%$	GREEN	D
$\pm 0.25\%$	BLUE	C
$\pm 0.1\%$	VIOLET	B
$\pm 0.05\%$	GRAY	

MULTIPLIER CHART

FOR THE NUMBER:	MULTIPLY BY:	FOR THE NUMBER:	MULTIPLY BY:
0	1	4	10,000
1	10	5	100,000
2	100	8	0.01
3	1000	9	0.1

CAPACITOR TOLERANCE CHART

LETTER	10 pF OR LESS	OVER 10 pF
B	$\pm 0.1 \text{ pF}$	
C	$\pm 0.25 \text{ pF}$	
D	$\pm 0.5 \text{ pF}$	
F	$\pm 1.0 \text{ pF}$	$\pm 1\%$
G	$\pm 2.0 \text{ pF}$	$\pm 2\%$
H		$\pm 3\%$
J		$\pm 5\%$
K		$\pm 10\%$
M		$\pm 20\%$

EXAMPLES: 151K = $15 \times 10 = 150 \text{ pF}$
 759 = $75 \times 0.1 = 7.5 \text{ pF}$

NOTE: The letter "R" may be used at times to signify a decimal point, as in: 2R2 = 2.2 (pF or μF).

Heathkit[®]

SPECIAL ASSEMBLY NOTES

NOTE: The following suggestions will not necessarily improve the operation of your kit. They will, however, help you troubleshoot it (if it ever becomes necessary), and help you perform the "Circuit Board Checkout" steps at the end of the assembly sections of this Manual. And you will have a more professionally-built kit when you finish.

1. When you install resistors, always position each resistor so you can read the bands on the resistor in the same direction as you can read the printing on the circuit board (see Figure 1). For resistors that have the value printed on them instead of color bands, install these resistors so the values are facing away from the circuit board and read in the same direction as the printing on the circuit board.

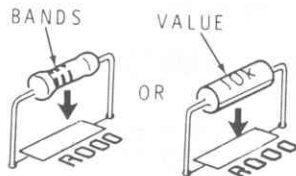

Figure 1

2. When you install ceramic, Mylar, or mica capacitors, always position each capacitor so you can read the value on the capacitor in the same direction as you can read the printing on the circuit board (see Figure 2).

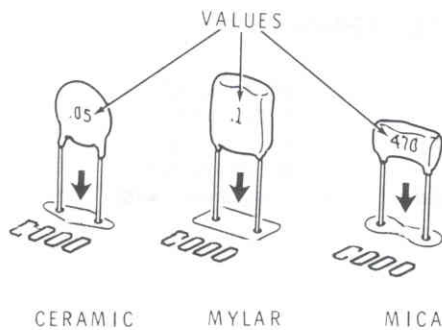

Figure 2

3. When you install electrolytic or other tubular capacitors, always position each capacitor so the value is facing away from the circuit board (see Figure 3). Be sure to observe the correct polarity when you install electrolytic capacitors (as you will be directed in the steps). Other, non-polarized, capacitors should be installed so you can read the values in the same direction as the printing on the circuit board.

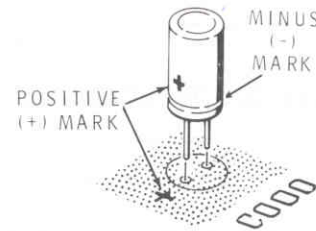

Figure 3

4. Install diodes so the type numbers or part numbers are facing away from the circuit board. Be sure to match the band on one end of each diode with the band mark on the circuit board.

PARTS LIST

Check each part against the following list. Return any part that is packed in an individual envelope back to the envelope after you identify it. Keep these parts in the envelopes until they are called for in an assembly step. Do NOT throw away any packing material until you have accounted for all the parts. The key numbers correspond to the numbers on the Parts Pictorial (Illustration Booklet, Pages 1 and 2).

To order a replacement part, always include the PART NUMBER. Use the Parts Order Form furnished with this kit. If a Parts Order Form is not available, refer to "Replacement Parts" inside the rear cover of this Manual.

KEY No.	HEATH Part No.	QTY.	DESCRIPTION	CIRCUIT Comp. No.
---------	----------------	------	-------------	-------------------

RESISTORS

1/2-Watt

NOTE: The following resistors have a 5% tolerance (gold fourth band).

A1	1-37	1	2.2 MΩ (red-red-grn-silver)	R101
A1	6-182	1	1800 Ω (brn-gry-red)	R102
A1	6-155	4	1.5 MΩ (brn-grn-grn)	R1, R2, R4, R5

Other Resistor

A2	3-15-5	1	75 Ω, 5-watt, 10% wire-wound	R103
----	--------	---	------------------------------	------

CAPACITORS

Ceramic

B1	21-803	2	25 pF	C3, C5
B1	21-71	2	.001 μF	C104, C105
B1	21-821	3	4700pF	C101, C102, C103
B1	21-16	1	.01 μF	C2
B1	21-38	3	.02 μF	C1, C106, C107

Electrolytic

B2	25-882	2	22 μF	C4, C6
----	--------	---	-------	--------

KEY No.	HEATH Part No.	QTY.	DESCRIPTION	CIRCUIT Comp. No.
---------	----------------	------	-------------	-------------------

DIODES-LED

C1	57-27	4	1N2071 diode	D1, D2, D102, D103
C2	412-633	1	Light-emitting diode (LED)	D101

OTHER ELECTRONIC PARTS

D1	45-6	1	8.48 μH RF choke	L101
D2	45-4	2	1 mH RF choke	L1, L102
D3	54-1031	1	Power transformer	T101
D4	60-2	1	Slide switch	SW101
D5	63-1398	1	Rotary switch	SW102
D6	69-85	2	Relay	RY1, RY2
D7	421-26	1	1/8 ampere slow-blow fuse	F101

INSULATORS

E1	75-52	1	Slide switch insulator
E2	75-182	1	Strain relief
E3	75-743	1	Insulating paper

TERMINAL STRIPS

F1	431-81	1	6-lug terminal strip w/ two mtg. feet
F2	431-86	1	6-lug terminal strip w/ one mtg. foot
F3	431-609	1	5-lug terminal strip

Heathkit®

KEY No.	HEATH Part No.	QTY.	DESCRIPTION	CIRCUIT Comp. No.
---------	----------------	------	-------------	-------------------

HARDWARE

NOTE: Hardware packets are marked to show the size of the hardware they contain (HDW #4 or HDW #6, etc.). You may have to open more than one packet to locate all of the hardware of one size (#6, for example).

#4 Hardware

G1	250-1412	8	4-40 × 3/8" screw
G2	252-2	8	4-40 nut
G3	254-9	8	#4 lockwasher

#6 Hardware

G4	250-28	1	6-32 × 1/4" setscrew
G5	250-1325	2	6-32 × 1/4" screw
G6	250-1280	6	6-32 × 3/8" screw
G7	250-1432	14	#6 × 3/8" sheet metal screw
G8	252-3	6	6-32 nut
G9	254-1	9	#6 lockwasher
G10	259-1	1	#6 solder lug

Other Hardware

G11	252-57	2	1/4-20 nut
G12	253-10	1	Control flat washer
G13	305-128	1	Set of parts consisting of:
G14		1	U-bolt
G15		2	U-bolt nut
G16		1	U-bolt outer plate
G17		1	U-bolt inner plate
		2	Plastic end caps (not used)

KEY No.	HEATH Part No.	QTY.	DESCRIPTION	CIRCUIT Comp. No.
---------	----------------	------	-------------	-------------------

WIRE-SLEEVE/TUBING

	89-22	1	Line cord
	344-125	6"	Black wire
	344-53	12"	Orange solid wire
	344-128	6"	Orange stranded wire
	344-219	6"	White wire
	346-1	5"	Black sleeving
	346-60	1	Tubing (1-1/2")

CONNECTORS

H1	432-866	3	Spring connector (1 extra supplied)
H2	432-1030	1	2-pin socket shell
H3	436-5	2	Coaxial jack
H4	436-52	5	Coaxial jack with hardware

METAL PARTS

J1	90-1293-1	1	Cabinet top
J2	200-1472-1	1	Control chassis
J3	200-1562	1	Remote chassis
J4	204-2772	1	Switch bracket

MISCELLANEOUS

	85-2958-1	1	Circuit board
K1	214-247	1	Plastic housing
K2	261-29	4	Plastic foot
K3	350-11	1	Silicone cement
K4	390-1023	1	Label set*
K5	390-1255	1	Fuse replacement label*
K6		1	Blue and white label*
K7	440-23	3	Protective cap
K8	462-1130	1	Knob
K9	490-5	1	Nut starter
	597-260	1	Parts Order Form*
	597-2771	1	Connector Installation Chart
		1	Assembly Manual (see Page 1 for the part number)

Solder

* These items may be packed inside this Manual.



STEP-BY-STEP ASSEMBLY

CIRCUIT BOARD

Refer to Pictorial 1-1 (Illustration Booklet, Page 2) as you read the following notes and steps.

In the following steps, you will be given detailed instructions on how to install and solder the first part on the circuit board. Read and perform each step carefully. Then use the same procedure whenever you install parts on the circuit board.

- () Position the circuit board as shown in the pictorial with the lettered component side up. Always install components on the component side of the circuit board, and solder the leads to the foil on the other side unless a step specifically directs you otherwise.
- () R1: Hold a 1.5 MΩ (brn-grn-grn) resistor as shown and bend the leads straight down with long-nose pliers to fit the hole spacing on the circuit board.

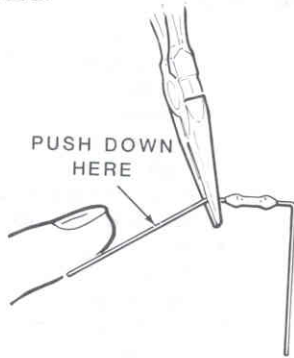

- () Start the leads into the holes at the resistor's location at the top of the circuit board. The end with the color bands may be positioned either way. NOTE: Resistors are identified by the following outline:

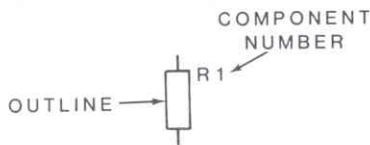

- () Press the resistor against the circuit board. Then bend the leads outward slightly to hold it in place.

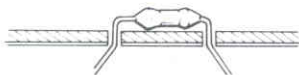

- () Solder the resistor leads to the circuit board as follows:

1. Push the soldering iron tip against both the lead and the circuit board foil. Heat both for two or three seconds.

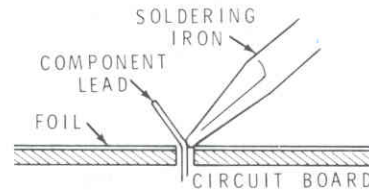

2. Then apply solder to the other side of the connection. IMPORTANT: Let the heated lead and the circuit board foil melt the solder.

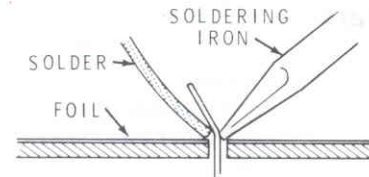

3. As the solder begins to melt, allow it to flow around the connection. Then remove the solder and the iron and let the connection cool.

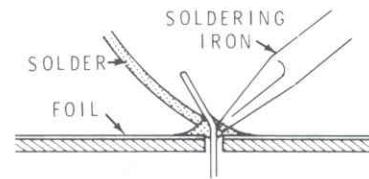

- () Cut off the excess lead lengths close to the connection. WARNING: Clip the leads so the ends will not fly toward your eyes.
- () Check each connection. Compare it to the illustrations on Page 11. After you have checked the solder connections, proceed with the assembly on Page 12. Use the same soldering procedure for each connection.

A GOOD SOLDER CONNECTION

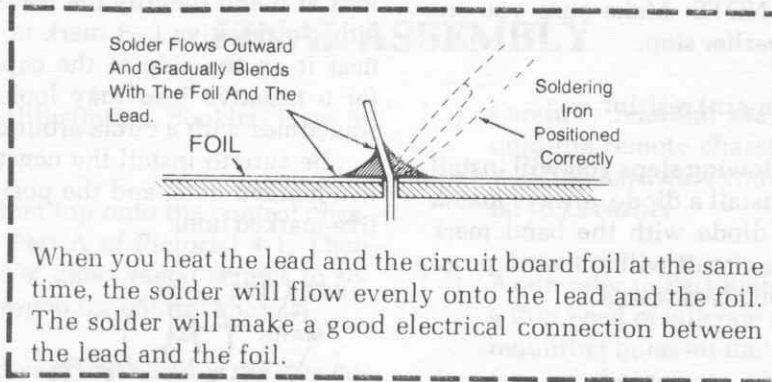

POOR SOLDER CONNECTIONS

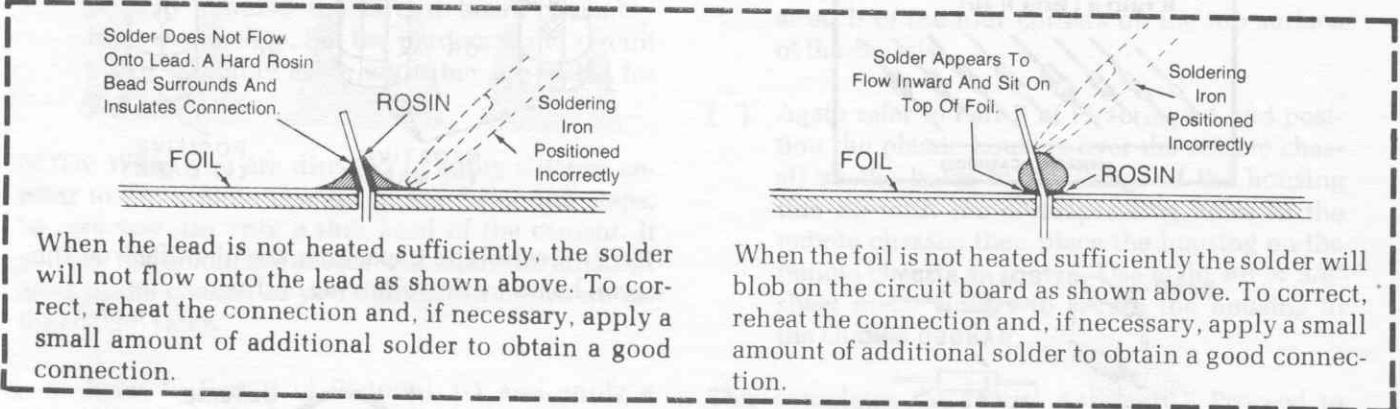

SOLDER BRIDGES

A solder bridge between two adjacent foils is shown in photograph A. Photograph B shows how the connection should appear. A solder bridge may occur if you accidentally touch an adjacent previously soldered connection, if you use too much solder, or if you "drag" the soldering iron across other foils as you remove it from the connection. A good rule to follow is: always take a good look at the foil area around each lead before you solder it. Then, when you solder the connection, make sure the solder remains in this area and does not bridge to another foil. This is especially important when the foils are small and close together. NOTE: It is alright for solder to bridge two connections on the same foil.

Use only enough solder to make a good connection, and lift the soldering iron straight up from the circuit board. If a solder bridge should develop, turn the circuit board foil-side-down and heat the solder between connections. The excess solder will run onto the tip of the soldering iron, and this will remove the solder bridge. NOTE: The foil side of most circuit boards has a coating on it called "solder resist." This is a protective insulation to help prevent solder bridges.

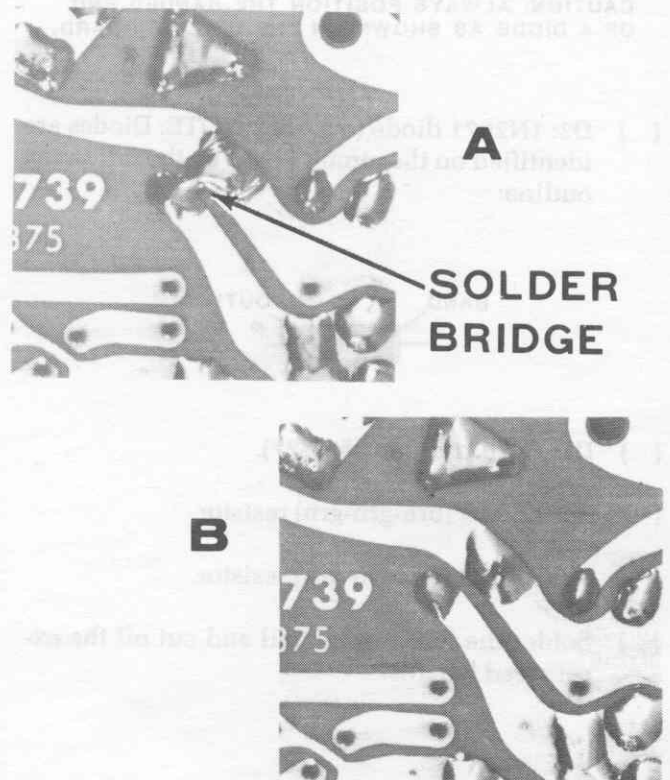

Start at the top of the circuit board and install the following components. NOTE: Make sure you installed resistor R1 in an earlier step.

- () R2: 1.5 MΩ (brn-grn-grn) resistor.

NOTE: In some of the following steps you will install diodes. Whenever you install a diode, always match the banded end of the diode with the band mark on the circuit board. The circuit will not work properly if the diode is installed backwards.

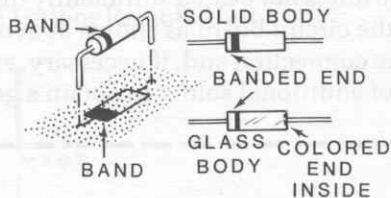
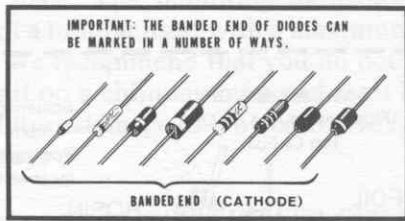

CAUTION: ALWAYS POSITION THE BANDED END OF A DIODE AS SHOWN ON THE CIRCUIT BOARD.

- () D2: 1N2071 diode (#57-27). NOTE: Diodes are identified on the circuit board by the following outline:



- () D1: 1N2071 diode (#57-27).
- () R5: 1.5 MΩ (brn-grn-grn) resistor.
- () R4: 1.5 MΩ (brn-grn-grn) resistor.
- (X) Solder the leads to the foil and cut off the excess lead lengths.

NOTE: Before you install an electrolytic capacitor, look at it and identify the leads. One lead will have either a negative (-) mark or a positive (+) mark near it on the side of the capacitor. (The marking for a negative lead may look like an oblong bar, sometimes with a circle around it, inside an arrow.) . . . Be sure to install the negative lead in the negative-marked hole, and the positive lead in the positive-marked hole.

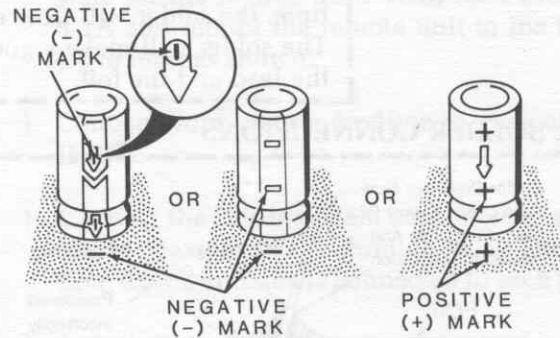

NOTE: Electrolytic capacitors are identified on the circuit board by the following outline:

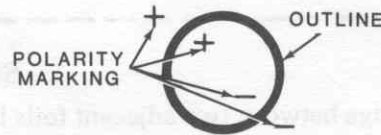

- (/) C6: 22 μF electrolytic capacitor.
- (/) C4: 22 μF electrolytic capacitor.

NOTE: In some of the following steps you will install disc-type ceramic capacitors. When you install these ceramic capacitors, do not push the insulated portion of the leads into the circuit board holes. Otherwise, this could make it difficult to solder the leads to the foil.

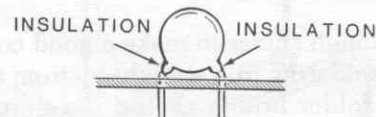

- () C2: .01 μF ceramic capacitor.

Heathkit®

- ✓ L1: 1 mH RF choke (#45-4). NOTE: Make sure you bend each of the two leads toward the slot in the form. Otherwise, you may break the fine wire that is used to wind the choke.

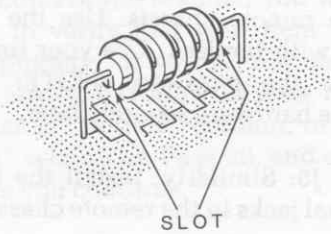

- () C5: 25 pF ceramic capacitor.
 () C3: 25 pF ceramic capacitor.
 () C1: .02 μ F ceramic capacitor.
 ✓ Solder the leads to the foil and cut off the excess lead lengths.
 () Check the lugs of each of the two relays (#69-85) to make sure they are straight.
 ✓ RY1: Install one of the relays at RY1. Be sure the relay is all the way down against the circuit board. Then solder the relay lugs to the foil.

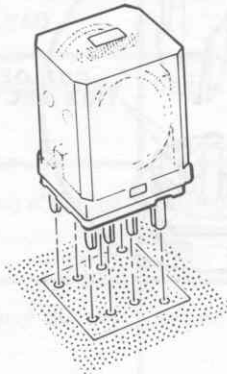

- ✓ RY2: Similarly, install the remaining relay at RY2.

CIRCUIT BOARD CHECKOUT

Carefully inspect the foil side of the circuit board for the following most-commonly-made errors:

- () Unsoldered connections.
 () Poor solder connections.
 () Solder bridges between foil patterns.
 () Protruding leads which could touch together when this circuit board is installed later.

Refer to the illustrations where parts were installed as you make the following visual checks:

- () Check diodes for proper installation (correct position of the banded end).
 ✓ Check electrolytic capacitors for the correct position of the plus (+) or minus (-) marked lead.

REMOTE UNIT

Refer to Pictorial 1-2 for the following steps.

- () Position the remote chassis as shown in the Pictorial.

CAUTION: When you trim the ground lug of each of the coaxial jacks, be careful so you do not bend it, as it may easily break. Also, clip off the excess metal from the lug so it does not fly toward your eyes.

- () Using diagonal cutters, trim the ground lug of one of the coaxial jacks (#436-52) as shown in the inset drawing on Pictorial 1-2. Then, from the non-lettered side of the circuit board, temporarily install the jack in one of the five jack locations. Make sure the jack is fully seated against the circuit board; then remove it from the circuit board and set it aside temporarily.

- () Similarly, trim the ground lug of each of the four remaining coaxial jacks. Be sure that all the jacks fit properly in the circuit board before you set them aside.

- () J1: Install one of the prepared coaxial jacks at J1 on the remote chassis. Use the hardware supplied with the jack. Use your fingers only to tighten the hardware. **NOTE:** You will tighten the hardware securely later.

- (✓) J2, J3, J4, J5: Similarly, install the remaining four coaxial jacks in the remote chassis.

- () Position the circuit board assembly over the remote chassis as shown in the Pictorial. Line up the lugs of each coaxial jack with the corresponding circuit board holes, and lower the circuit board assembly onto the lugs. Carefully push the circuit board down so it is fully seated against the five coaxial jacks. Then solder both lugs of each of the five jacks to the circuit board foil.

- (✓) Set the remote chassis aside until it is called for in a step.

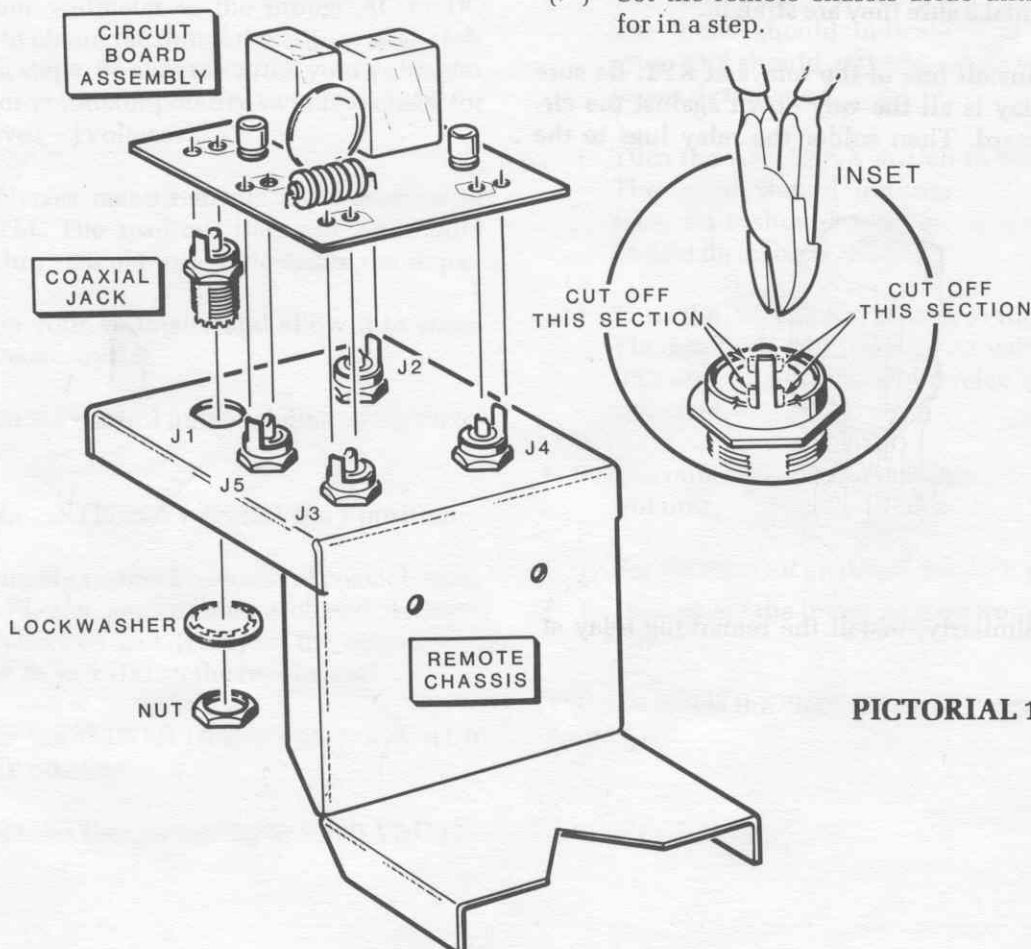

PICTORIAL 1-2

Heathkit®

CONTROL UNIT

Refer to Pictorial 2-1 (Illustration Booklet, Page 3) for the following steps.

- () Refer to Detail 2-1A and temporarily position the control chassis bottom side up as shown. Then carefully peel the backing paper from each of the four plastic feet and press them into place near each corner of the chassis. Be careful that you do not cover up any holes in the chassis.
- () Carefully peel the backing paper from the blue and white label. Then press the label onto the bottom of the chassis in the area shown in Detail 2-1A. Be sure to refer to the numbers on the label in any communications you have with the Heath Company about this kit.
- () Reposition the control chassis bottom side down as shown in Pictorial 2-1.
- () Use sandpaper or a knife to scrape any excess paint away from the areas shown in the Pictorial.

rial. The hardware you will mount at these locations requires a good contact with the metal chassis.

NOTE: Use the plastic nut starter supplied with this kit to hold and start 4-40 and 6-32 nuts on screws.

- () Mount a #6 solder lug at A on the control chassis. Use a 6-32 × 3/8" screw and a 6-32 nut. Be sure to position the solder lug as shown.

NOTE: Only the screw size is called out in the following steps. When a step calls for "6-32 × 3/8" hardware," for example, it means that you should use a 6-32 × 3/8" screw, one or more #6 lockwashers, and a 6-32 nut. The Pictorial referred to in the step shows the proper number and use of the lockwashers.

- () J102: Mount a coaxial jack onto the inside of the rear panel at J102. Use 4-40 × 3/8" hardware.

- (✓) J101: Similarly, mount the remaining coaxial jack onto the inside of the rear panel at J101.

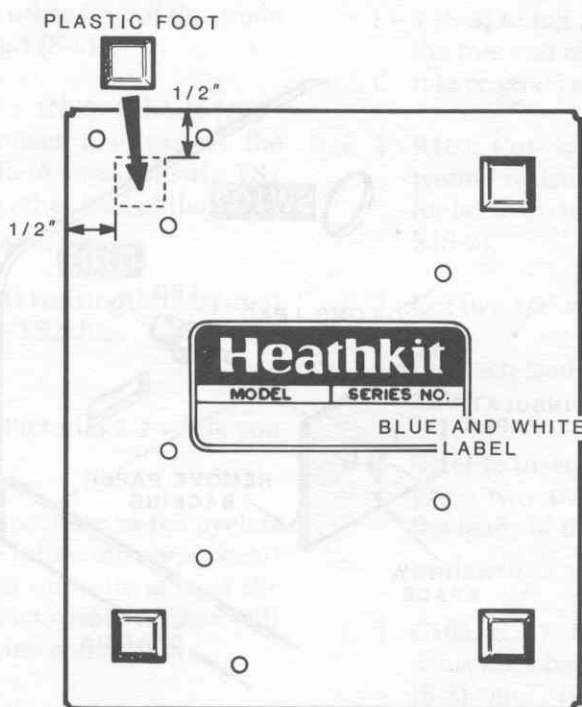

Detail 2-1A



- () D101: Refer to Detail 2-1B and use the following procedure to mount the light-emitting diode (LED, #412-633) onto the front of the control chassis at D101:
1. Position the insulating paper as shown. Note that the hole is closer to one side of the insulating paper than it is to the other.
 2. Carefully peel the backing paper from the insulating paper. Position the insulating paper and the LED as shown; then push the LED leads all the way into the hole. Note that the LED has a short lead and a long lead.
 3. Start the LED into hole D101 in the front of the control chassis so the side of the paper that is closest to the hole is toward the bottom of the chassis and the long lead of the LED is toward the mounting hole for switch SW102. Then press the insulation paper onto the inside of the front panel.
 4. Cut each LED lead to 3/8".
- () Position the slide switch insulator next to the slide switch so the holes in the insulator line up with the corresponding switch lugs. Then carefully push the insulator all the way onto the switch lugs. Carefully bend each of the two center lugs outward slightly.
- () Position the switch bracket as shown. Then mount the slide switch onto the bracket with two 6-32 × 1/4" screws. Center the switch lever in the rectangular cutout before you tighten the screws.
- () SW101: Mount the switch bracket with slide switch at E. Use two #6 × 3/8" sheet metal screws.
- () Move the switch lever back and forth to make sure it moves freely. If it does not, remove the bracket from the chassis, loosen the two 6-32 × 1/4" screws, and reposition the switch as necessary. Then remount the switch.

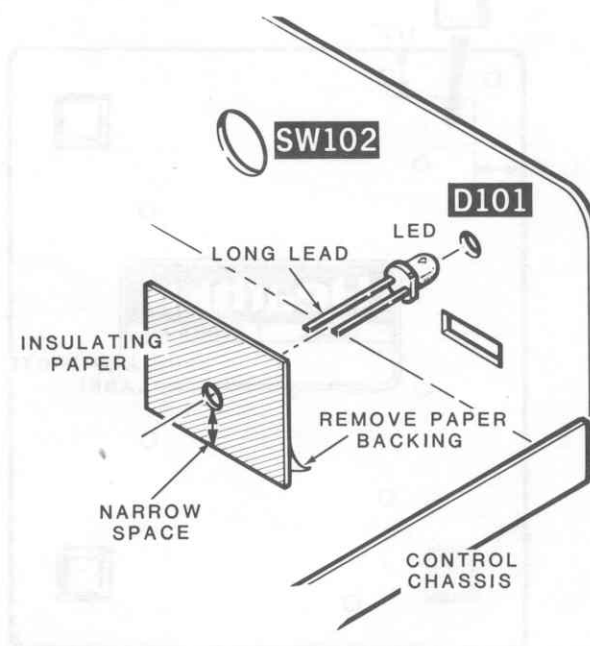

Detail 2-1B

Heathkit®

- () Turn the shaft of the rotary switch fully counterclockwise.
 - () Refer to Detail 2-1C and use the following procedure to prepare the rotary switch (#63-1398):
 1. Using diagonal cutters, cut about 1/32" off the locating tab on the switch.
 2. Remove the hardware from the switch bushing. NOTE: To remove the metal ring, hold the switch with the shaft down; the metal ring will fall off of the bushing.
 3. Notice that the numbers 2 through 11 are imprinted on the front of the switch as shown in the Detail. Place the metal ring on the switch bushing, making sure the tab of the metal ring enters the small hole closest to the number 4.
 - () Start a 6-32 × 1/4" setscrew into the knob.
 - () Push the knob onto the shaft of switch SW102. Then line up the knob pointer with the "1" on the front panel and tighten the setscrew (against the flat on the shaft).
 - () Mount the 5-lug terminal strip at B on the control chassis. Use 6-32 × 3/8" hardware. Be sure to position the terminal strip as shown.
 - () Loosely mount the indicated end of the 6-lug terminal strip (with two mounting feet) at C on the control chassis. Be sure to position the terminal strip as shown. NOTE: You will mount the other end of this terminal strip later.
 - () Using diagonal cutters, cut the 6-lug terminal strip (with one mounting foot) at the location shown in the Pictorial. Discard the cutoff section.
 - () Mount the prepared 5-lug terminal strip and the "free" end of the 6-lug terminal strip at D with 6-32 × 3/8" hardware.
 - () Tighten the hardware at C and D.
- ✓ SW102: Mount the rotary switch onto the front of the control chassis at SW102. Use the hardware supplied with the switch and a control flat washer to secure it. Position the switch so the flat of the switch shaft is parallel with the bottom edge of the front panel as shown in the inset drawing on Pictorial 2-1. Then tighten the hardware. Do not overtighten.

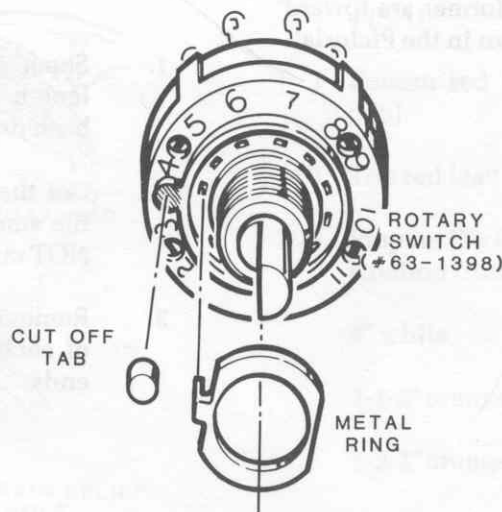

Detail 2-1C



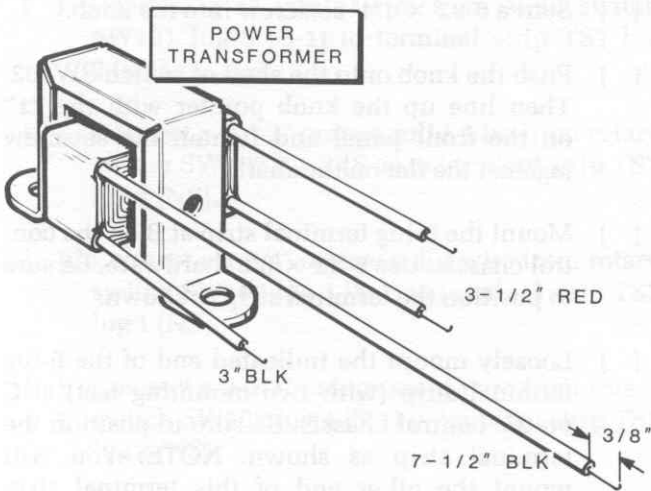

Detail 2-1D

CAUTION: When you remove the insulation from the end of each transformer lead, hold the lead between the transformer and the lead end. Otherwise, you may pull the lead out of the transformer.

- () Refer to Detail 2-1D and cut the power transformer leads to the indicated lengths. Measure the leads from where they exit the transformer body. Then remove 3/8" of insulation from the end of each lead.
- (✓) Mount the transformer to the chassis at T101 with 6-32 × 3/8" hardware. Be sure the red leads coming from the transformer are toward rotary switch SW102 as shown in the Pictorial.

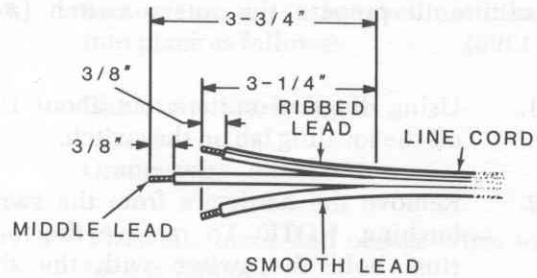

Detail 2-2A

Refer to Pictorial 2-2 (Illustration Booklet, Page 4) for the following steps.

NOTE: When a step directs you to prepare the end(s) of a stranded wire (or lead), first cut the wire to the indicated length and remove the indicated amount of insulation from the wire end. Tightly twist together the fine strands at the end of the wire. Then melt a small amount of solder on the wire end to hold the strands together.

(✓) Refer to Detail 2-2A and use the following procedure to prepare the free end of the line cord:

1. Separate the three line cord leads for a length of 3-3/4", if this has not already been done.
2. Cut the free end of both the ribbed and the smooth line cord leads to 3-1/4". Do NOT cut the middle line cord lead.
3. Remove 3/8" of insulation from the end of each line cord lead and prepare the ends.



Heathkit®

(/) Refer to Detail 2-2B and use the following procedure to secure the strain relief and line cord to the rear panel at F:

1. Refer to Part A of the Detail and place a strain relief over the line cord as shown.
2. Refer to Part B of the Detail and, from the outside of the rear panel, pass the free end of the line cord through hole F. Using gas pliers, squeeze the two segments of the strain relief firmly together to fit the chassis hole.
3. Refer to Part C of the Detail and insert the end of the strain relief into the hole.

PART A

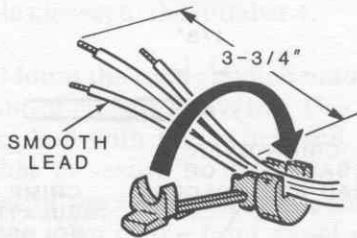

PLACE THE LINE CORD IN THE SLOT.

PART B

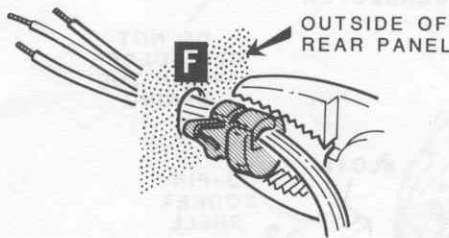

SQUEEZE THE TWO SEGMENTS TOGETHER.

PART C

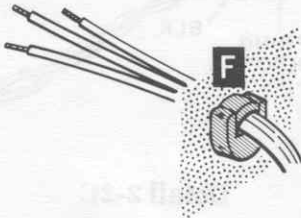

INSERT THE STRAIN RELIEF INTO THE HOLE

Detail 2-2B

NOTES:

1. Refer to inset drawing #1 on Pictorial 2-2 when you are directed to make a mechanically secure connection.
2. In the following steps, (NS) means not to solder the connection because you will add other wires later. "S" with a number, such as (S-3), means to solder the connection. The number following the "S" tells how many wires should be at the connection. This helps you check your work for errors as you assemble the kit.

Connect the line cord leads as follows. Be sure to make mechanically secure connections.

- () Green lead to solder lug A (S-1). Do not shorten this wire.
- () Ribbed lead to terminal strip TS1 lug 5 (NS).
- (/) Smooth lead to terminal strip TS1 lug 4 (NS).

Connect the free end of each of the leads coming from power transformer T101 as follows. Be sure to make mechanically secure connections.

- () Long black lead to terminal strip TS1 lug 5 (NS).
- () Short black lead to slide switch SW101 lug 4 (S-1).
- () Bottom red lead to terminal strip TS2 lug 2 (NS).
- (/) Top red lead to terminal strip TS2 lug 3 (NS).
- (/) Prepare the following wires (remove 1/4" of insulation from each end):

6" white

3-1/2" orange solid

1-3/4" orange solid

2-1/2" orange solid

3-1/4" orange solid

- () Connect a 6" white wire from slide switch SW101 lug 5 (S-1) to terminal strip TS1 lug 2 (S-1).
- () Connect a 3-1/2" orange solid wire from rotary switch SW102 lug 2 (S-1) to terminal strip TS2 lug 4 (NS).
- () Connect a 1-3/4" orange solid wire from rotary switch SW102 lug 3 (S-1) to terminal strip TS2 lug 1 (NS).
- () Connect a 2-1/2" orange solid wire from rotary switch SW102 lug 4 (S-1) to terminal strip TS2 lug 3 (NS).
- () Connect a 3-1/4" orange solid wire from rotary switch SW102 lug A (S-1) to terminal strip TS3 lug 2 (NS).

NOTE: When you prepare wires in the following step, first cut each wire to the length called for and remove 1/8" of insulation from one end. Twist together the ends of each wire and apply a thin film of solder to hold the fine wire strands together. Then remove 1/4" of insulation from the other end of each wire, twist the ends and apply solder.

() Prepare the following wires:

6" black

6" orange stranded

Refer to Detail 2-2C while you perform the next three steps.

- () 1. Solder a spring connector onto only the 1/8" end of each wire.

- () 2. Position a 2-pin socket shell with the slots up as shown. Position the spring connectors on the prepared 6" wires so the tabs are up as shown. Then push the spring connectors into the socket shell until they lock into place as follows:

Black wire into hole 1

Orange wire into hole 2

- () 3. Twist the black and orange wires together for a length of 4".

- (/) Connect the free end of each 6" wire to terminal strip TS2 as follows:

Black wire to lug 2 (S-2).

Orange wire to lug 5 (NS).

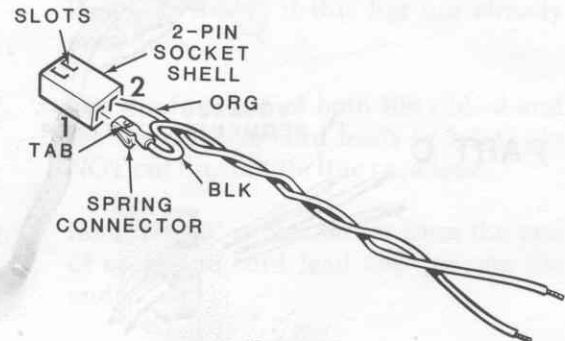
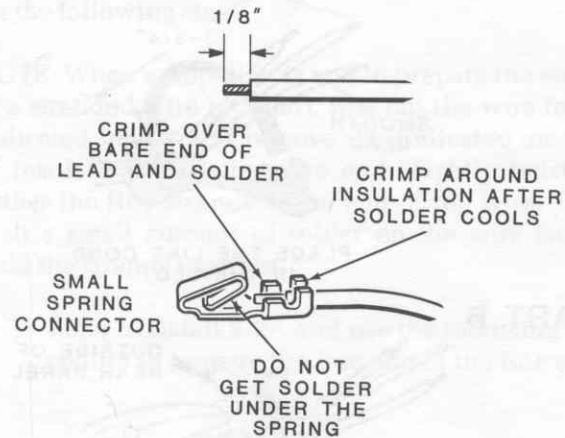

Detail 2-2C

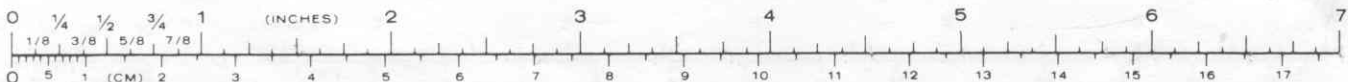

Heathkit®

Refer to inset drawing #2 on Pictorial 2-2 while you perform the next four steps.

- () 1. C103: Cut each lead of a 4700pF ceramic capacitor to 1/2". Then connect the capacitor between terminal strip TS1 lugs 3 (NS) and 4 (NS).
- () 2. C102: Cut each lead of a 4700pF ceramic capacitor to 1/2". Then connect the capacitor between terminal strip TS1 lugs 4 (NS) and 5 (NS).
- () 3. Cut two 1/2" lengths of black sleeving.
- () 4. C101: Cut each lead of a 4700pF ceramic capacitor to 3/4". Then place a 1/2" length of black sleeving over each lead. Connect the capacitor between terminal strip TS1 lugs 3 (NS) and 5 (S-4).
- () 5. R101: Cut each lead of a 2.2 MΩ resistor to 3/4". Then connect the resistor between terminal strip TS1 lugs 3(S-3) and 4(S-4).
- () D103: Connect the lead at the banded end of a 1N2071 diode (#57-27) to terminal strip TS2 lug 3 (NS). Connect the other lead of the diode to terminal strip TS2 lug 1 (S-2).
- () D102: Cut each lead of a 1N2071 diode (#57-27) to 1/2". Then connect the lead at the banded end of the diode to terminal strip TS2 lug 4 (S-2). Connect the other lead of the diode to terminal strip TS2 lug 3 (NS).
- () R102: Connect an 1800 Ω resistor (brn-gry-red) between terminal strip TS2 lugs 3 (S-5) and 5 (S-2).

Refer to inset drawing #3 on Pictorial 2-2 while you perform the next two steps.

NOTE: When you connect capacitors to the eyelets of terminal strip TS3 in the following steps, bend the leads over sharply on the opposite side of the terminal strip as shown in Pictorial 2-2. This will help make a mechanically secure connection.

- () C104: Cut each lead of a .001 μF ceramic capacitor to 3/8". Then connect the capacitor between eyelets 1 (S-1) and 2 (S-1) of terminal strip TS3.

- () C105: Cut each lead of a .001 μF ceramic capacitor to 3/8". Then connect the capacitor between eyelets 5 (S-1) and 6 (S-1) of terminal strip TS3.

NOTE: In the following steps, the solder instructions will not include any leads that are already soldered to the eyelets of terminal strip TS3.

- () L101: Cut each lead of an 8.48 μH RF choke (#45-6) to 3/4". Then connect the choke between terminal strip TS3 lugs 2 (S-2) and 5 (NS).

- () Cut a 3/4" length of black sleeving.

NOTE: Where a lead passes through a connection and then goes to another point, as in the following step, it will count as two wires in the solder instructions (S-2). In this instance, one lead is entering while the same lead is leaving the connection. Be especially careful that you apply enough solder and heat when soldering these "through wires."

- () L102: Place a 3/4" length of black sleeving over one lead of a 1 mH RF choke (#45-4). Then connect the lead with the sleeving through lug 4 (S-2) to lug 3 (NS) of terminal strip TS3. Cut the free end of the choke to 1-1/4" and connect it to coaxial jack J102 lug 1 (NS).
- () R103: Cut each lead of a 75 Ω, 5-watt, wire-wound resistor to 3/4". Then connect the resistor between terminal strip TS3 lugs 3 (S-2) and 5 (S-2).

- () Cut two 1/2" lengths of black sleeving.

- () Cut each lead of two .02 μF ceramic capacitors to 1".

- () Refer to inset drawing #4 on Pictorial 2-2 and place two 1/2" lengths of black sleeving over the leads of the two .02 μF ceramic capacitors as shown.

- () C106, C107: Connect the two .02 μF ceramic capacitors between coaxial sockets J101 lug 1 (S-2) and J102 lug 1 (S-3). Position the capacitors at least 1/4" away from the chassis bottom and as shown in the Pictorial.

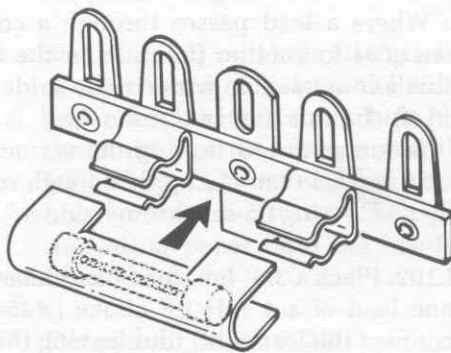
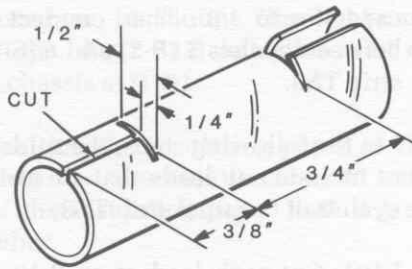

Detail 2-2D

- () Refer to Detail 2-2D and, using a pair of scissors or a knife, cut the 1-1/2" of clear tubing as shown.
- () Place the prepared tubing over the 1/8-ampere fuse. Then mount the fuse with tubing in the fuse clips on terminal strip TS1.
- () Write the following information on the fuse label:
 "1/8-ampere, 3AG, slow-blow"
- () Remove the backing paper from the fuse label. Then press the label onto the inside of the rear panel at the location shown.
- () S101: Position the 2-pin socket with the slots down next to the leads of LED D101. Then push the socket all the way onto the leads of the LED.

This completes the "Step-by-Step Assembly" of your Remote Coax Switch. Shake out any loose pieces of wire and solder. Then proceed to "Initial Tests."



INITIAL TESTS

In this section of the Manual, you will perform certain tests to verify that your Remote Coax Switch operates properly. If you do not obtain the correct results in any of the following tests, refer to the "Possible Cause of Trouble" column, or the "In Case of Difficulty" section on Page 28, and correct the problem before you continue.

PRIMARY WIRING TESTS

IMPORTANT: A wiring error in the primary wiring circuit (line cord, power switch, etc.) of your kit could cause you to receive a severe electrical shock. These "Primary Wiring Tests" will help you eliminate any such wiring errors that may exist.

Refer to Pictorial 3-1 (Illustration Booklet, Page 5) for the locations of the "test points" called out in the following steps.

- () Be sure the line cord plug is not connected to an AC outlet.

- () Be sure the front panel POWER OFF/ON switch is set to the OFF position.

- () Turn the ANTENNA switch to the 2 position.

NOTE: If you do not have an ohmmeter, carefully check the line cord, switch SW101, terminal strip TS1, and transformer wiring against the wiring shown in Pictorial 2-2. Make sure there are no fine strands of wire or solder globs touching adjacent terminals on the control chassis. If you have an ohmmeter, perform the following resistance measurements. **NOTE:** You will be instructed to connect one of the ohmmeter leads to ground. You may use terminal strip TS3 lug 1 for this.

- () Turn on your ohmmeter and allow it to warm up, if necessary.

- () Set the ohmmeter to its R × 10 range.

NOTE: If you do not get the proper reading in any of the following steps, reverse the meter leads; then repeat the step.

METER CONNECTIONS		METER READING	POSSIBLE CAUSE OF TROUBLE
POSITIVE LEAD	COMMON LEAD		
() Either flat prong of the line cord plug.	Ground.	INFINITE with POWER switch ON or OFF.	A. Wiring of switch SW101. B. Wiring of transformer T101.
() Other flat prong of the line cord plug.	Ground.	INFINITE with POWER switch ON or OFF.	A. Wiring of switch SW101. B. Wiring of transformer T101.
() Round prong of the line cord plug.	Ground.	0 Ω with the POWER switch ON or OFF.	A. Center wire not connected from line cord to solder lug A. See Pictorial 2-2 (Illustration Booklet, Page 4).
() Either flat prong of the line cord plug.	Other flat prong.	INFINITE with POWER switch OFF.	A. Wiring of switch SW101. B. Wiring of transformer T101.
() Either flat prong of the line cord plug.	Other flat prong.	50-100 Ω with POWER switch ON.	A. Wiring of switch SW101. B. Wiring of transformer T101.
() Center pin of ANTENNA jack J102.	Ground.	INFINITY.	A. Wiring of rotary switch SW102.

POWER ON TESTS

CAUTION: When the line cord plug is connected to an AC outlet, AC voltage will be present at several places on the control unit, as shown in Pictorial 3-1 (Illustration Booklet, Page 5). Be careful that you do not contact this voltage because an electrical shock will result.

NOTE: A DC voltmeter is required for the following tests. You may use a VOM (volt-ohmmeter), a VTVM (vacuum-tube voltmeter), or a DMM (Digital Multimeter).

Refer to Pictorial 3-1 (Illustration Booklet, Page 5) for the following steps.

NOTES:

1. If you fail to obtain the desired readings in any of the following steps, set the POWER switch to OFF. Then refer to the "In Case of Difficulty" section on Page 28 of this Manual.
2. Set your voltmeter to the proper AC or DC range to obtain meaningful readings in the following steps. Be sure to switch your voltmeter leads or voltmeter polarity switch to check for negative (-) voltages.
3. All voltages measurements were taken with a VTVM. The readings that you get should be within 10% of those indicated in the steps.
 - Turn on your voltmeter and allow it to warm up, if necessary.
 - Position the control unit as shown in the Pictorial.
 - Turn the ANTENNA switch to the 1 position.
 - Temporarily connect a length of coaxial cable, with a PL-259 connector on each end, between the ANTENNA jack (J102) on the control unit and the IN jack (J5) on the remote unit.
 - Be sure the POWER OFF/ON switch is set to the OFF position.
 - Connect the line cord plug to a 120 VAC outlet.

- Connect the common (negative) lead of your DC voltmeter to terminal strip TS3 lug 1. **CAUTION:** Make sure this lead does not accidentally touch any of the lugs on terminal strip TS1, as the AC line voltage is present on some of these lugs.

- Set the POWER switch to the ON position. The front panel LED lamp should light. Neither of the two relays (RY1 or RY2) in the remote unit should click (activate).

NOTE: In the following steps, you will measure the voltage at the center pin of the control unit's ANTENNA jack for each of the four positions of the ANTENNA switch. Touch the test probe to this center pin for each of the four measurements.

- Touch the test probe of your voltmeter to the center pin on the control unit's ANTENNA jack (J102). The meter should indicate 0 volt. Neither of the two relays (RY1 and RY2) should click.
- Turn the ANTENNA switch to the 2 position. The meter should indicate +20 volts. Only relay RY2 should activate, while relay RY1 remains deactivated.
- Turn the ANTENNA switch to the 3 position. The meter should indicate -20 volts. Only relay RY1 should activate, while relay RY2 should deactivate.
- Turn the ANTENNA switch to the 4 position. The meter should indicate 22 volts AC. Relay RY2 should activate, while relay RY1 remains activated.
- Disconnect the voltmeter leads from the control unit.
- Set the POWER switch to the OFF position.
- Disconnect the line cord plug from the AC outlet.

This completes the "Initial Tests." Proceed to "Final Assembly."

FINAL ASSEMBLY

Refer to Pictorial 4-1 (Illustration Booklet, Page 6) for the following steps.

- () Position the cabinet top onto the control chassis as shown in Part A of Pictorial 4-1. Then use four #6 × 3/8" sheet metal screws to secure the cabinet top to the control chassis.
 - () Remove the hardware that secures the five coaxial jacks to the remote chassis. Then temporarily remove the circuit board assembly from the chassis. Set the hardware and circuit board assembly aside until they are called for in a step.
- NOTE: When you are directed to apply silicone cement to the remote chassis in the following steps, be sure you use only a thin bead of the cement. If you use too much, the excess will leak onto adjacent areas of the chassis as you tighten the hardware for the coaxial jacks.
- () Refer to Part B of Pictorial 4-1 and apply a thin bead of silicone cement around the edge of each of the five "D"-shaped holes in the remote chassis.
 - () Carefully remount the circuit board assembly onto the remote chassis. Secure the assembly with the hardware you removed from the coaxial jacks earlier.
 - () Again refer to Part B of Pictorial 4-1 and apply a thin bead of silicone cement in line with the mounting holes all the way around the top surface of the remote chassis as shown. Then apply an additional bead of silicone cement at each of the four corners on the top surface of the chassis.
 - () Again refer to Part B of Pictorial 4-1 and position the plastic housing over the remote chassis so the holes in the flange of the housing line up with the corresponding holes in the remote chassis; then place the housing on the remote chassis as shown. Use eight #6 × 3/8" sheet metal screws to secure the housing to the chassis.

This completes the "Final Assembly." Proceed to "Installation."

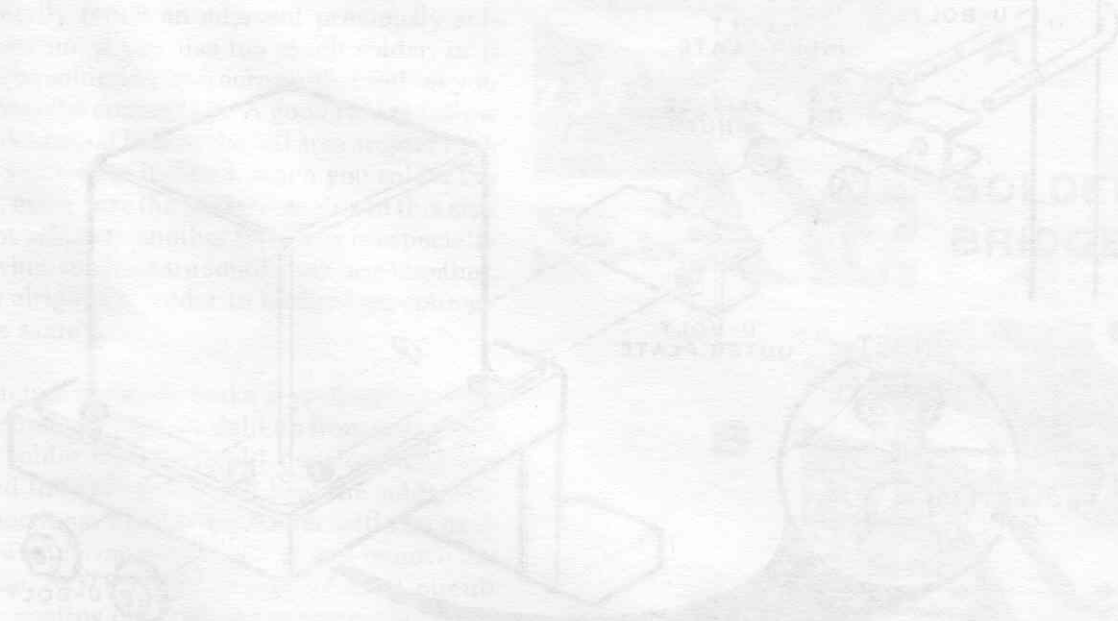

INSTALLATION

This section of the Manual gives you general information for mounting and connecting the remote unit. Your installation may vary to suit your particular requirements.

MOUNTING INSTRUCTIONS

You should mount the remote unit on an existing tower or mast. The mounting hardware supplied will accept a tubular mast with a maximum diameter of 1-1/2". We recommend that you do not install the remote unit on a chimney-mounted mast because of possible future damage to it by corrosive fumes from the chimney.

NOTE: Be sure you set the POWER OFF-ON switch of the Control Unit to the OFF position before you connect any cables to or disconnect any cables from the Control Unit or Remote Unit.

Refer to Pictorial 5-1 (Illustration Booklet, Page 6), which shows two suggested mounting methods, for the following steps.

- () Open the bag containing the mounting hardware for the remote unit. Then refer to Detail 5-1A and mount the remote unit to the tower leg or mast as shown.
- () Connect your station feedline to coaxial jack J5 (IN).
- () Connect the feedline from each of your antennas to coaxial jacks J1 through J4. Be sure you note which antenna is connected to each jack.
- () Install protective caps on any unused coaxial jacks. See the inset drawing on Detail 5-1A.

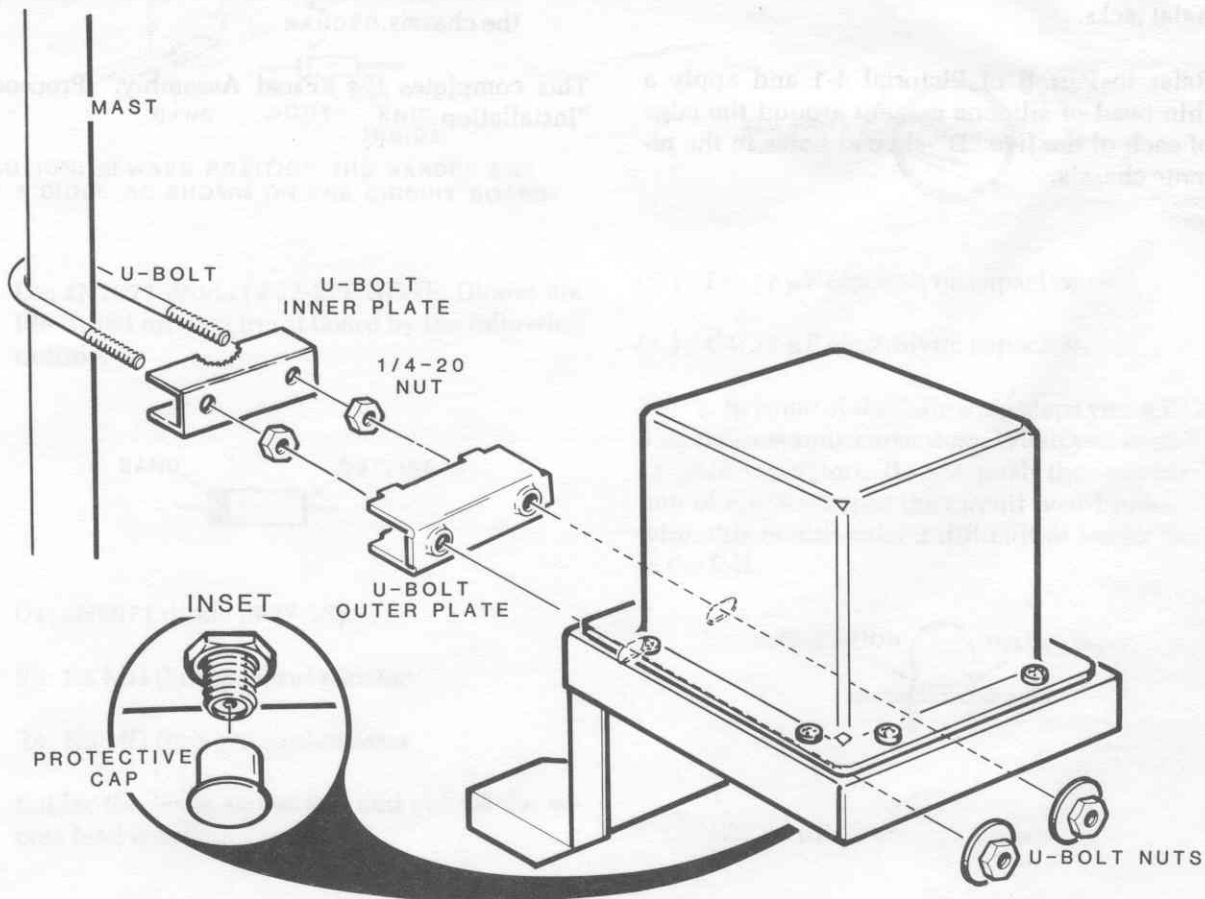

Detail 5-1A

OPERATION

Refer to Pictorial 6-1 as you read the following information.

Each of the four switch positions has a number within a circle on the front of the control unit. Also, a separate label set has been provided so, if you wish, you can place any of the numbers or symbols from the label set over the circles on the front of the control unit.

To operate the Remote Coax Switch, simply follow this procedure:

1. Push POWER switch SW101 to ON. LED D101 on the front panel will light.
2. Select the desired antenna by turning rotary switch SW102 to the proper position.
3. NOTE: When POWER switch SW101 is in the OFF position, the remote unit automatically selects the antenna connected to coaxial jack J1 (antenna #1). Be sure to keep this in mind when you are transmitting.
4. **Do NOT switch antennas while RF power is being applied to the Remote Coax switch.**



LABEL SET

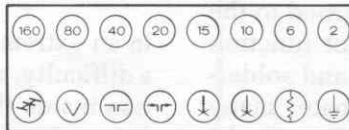

PICTORIAL 6-1

IN CASE OF DIFFICULTY

NOTE: It is important that you read the entire "General Troubleshooting Information", which follows, before you attempt to service your Remote Coax Switch.

This section of the Manual is divided into two parts. The first part, titled "General Troubleshooting Information," describes what to do about the difficulties that may occur right after your Remote Coax Switch is assembled.

The second section, titled "Troubleshooting Chart," is provided to assist you in servicing the Remote Coax Switch if the "General Troubleshooting Information" fails to clear up the problem, or if difficulties occur after your Remote Coax Switch has been in use for some time. The "Troubleshooting Chart" lists a number of possible difficulties that could arise along with several possible solutions to those difficulties. Refer to the "Circuit Board X-Ray View" on Page 33 for the physical location of parts on the circuit board.

GENERAL TROUBLESHOOTING INFORMATION

1. Recheck the wiring. Trace each lead with a colored pencil as you check it. It is frequently helpful to have a friend check your work. Someone who is not familiar with the unit may notice something consistently overlooked by the kit builder.
2. About 90% of the kits that are returned to the Heath Company for service do not function properly due to poor connections and soldering. Therefore, you can eliminate many troubles by checking all connections to make sure that they are soldered correctly. Reheat the connections, if necessary, but be careful so you do not create any solder bridges.
3. Check the values of all the parts. Be sure that the proper part has been installed at each location on the circuit board. Refer to the "Circuit Board X-Ray View" for the physical location of parts on the circuit board.
4. Be sure that all the wires and leads have been trimmed as close as possible to their connecting points.
5. Check for bits of solder, wire ends, or other foreign matter which may be lodged in the wiring or in the components on the circuit board.
6. Check very carefully to be sure there are no solder bridges between different circuit board foils. If you are not sure a solder bridge exists, compare the circuit board foil with the "Circuit Board X-Ray View." Remove any solder bridges by turning the circuit board foil-side down and holding a clean, hot soldering iron tip between the two points that are bridged until the excess solder flows down onto the tip.

If you still cannot locate and correct the trouble after you have completed the checks listed above, and if a voltmeter is available, check the voltages in the Remote Coax Switch against the Schematic. A review of the "Circuit Description" and Schematic may also help you to locate any difficulties in the kit.

In an extreme case where you are unable to resolve a difficulty, refer to the "Customer Service" information inside the rear cover of this Manual. Your Warranty is located inside the front cover.

Troubleshooting Chart

This chart lists the condition and possible causes of several malfunctions. If a particular part is mentioned (D1, for example) as a possible cause, check that part to see if it was installed correctly. Also, check it and the parts connected to it for poor connections. It is also possible, on rare occasions, for a part to be faulty and require replacement.

CONDITION	POSSIBLE CAUSE
Coax Switch completely inoperative; LED D101 is not lit (RF power is applied to ANT #1 only).	<ol style="list-style-type: none"> 1. Fuse F101. 2. Power supply wiring.
Coax Switch operative; LED D101 is lit. However, RF power is applied to ANT #1 only.	<ol style="list-style-type: none"> 1. Chokes L101 or L102. 2. Resistor R103. NOTE: Check for the proper voltage at TP101 (See the Schematic Diagram).
The selected antenna does not correspond with the correct setting of ANTENNA switch SW102.	<ol style="list-style-type: none"> 1. Diodes D102 or D103. 2. Relays RY1 or RY2. NOTE: Check for the proper voltage at TP101 and the center lug of J5.

SPECIFICATIONS

Frequency Operating Range	1.8 to 54 MHz.
Loss at 54 MHz	Less than .2dB.
VSWR	1.15:1 or less (below 30 MHz).
Impedance	50-75 ohms.
Power Handling Capability	2000 watts PEP.
Temperature Range	-40 °F to +177 °F (-40 °C to +80 °C).
Number of Ports	4.
Power Requirements	7.5 watts @ 120 VAC, 50/60 Hz.
Dimensions	
Remote Unit	7-3/8" H × 8-3/8" W × 4-7/16" D (18.7 × 21.3 × 11.3 cm).
Control Unit	2-5/8" H × 5-1/2" W × 7-1/2" D (6.7 × 14.0 × 19.1 cm).
Net Weight	
Remote Unit	1.5 lbs (.7 kg).
Control Unit	1.9 lbs (.9 kg).

The Heath Company reserves the right to discontinue products and to change specifications at any time without incurring any obligation to incorporate new features in products previously sold.

CIRCUIT DESCRIPTION

Refer to the Schematic and the Block Diagram (Illustration Booklet, Page 7) as you read the following description.

The 120 VAC line voltage is applied through fuse F101 and power OFF-ON switch SW101 to the primary winding of power transformer T101. Antenna switch SW102 selects a specific AC or DC voltage level for each of its four positions. The following paragraphs explain the mode of operation for each of these four switch positions.

In position 1, no voltage is applied to the remote unit, which normally feeds the RF signal through relay RY1 lugs 6 and 2, and then through relay RY2 lugs 5 and 1 to antenna jack J1 (ANT 1).

In position 2, the AC voltage across the secondary winding of T101 is rectified by diode D103 to produce a positive voltage. This DC voltage forward biases diode D1 and energizes relay RY2. This allows the RF signal to be fed through RY2 lugs 5 and 3 to antenna jack J2 (ANT 2). At this time, diode D2 is reverse biased and relay RY1 remains de-energized.

In position 3, the AC voltage across the secondary winding of T101 is rectified by diode D102 to produce a negative voltage. This DC voltage forward biases diode D2 and energizes relay RY1. This al-

lows the RF signal to be fed through relay RY1 lugs 6 and 4, and then through relay RY2 lugs 6 and 2 to antenna jack J3 (ANT 3). At this time, diode D1 is reverse biased and relay RY2 remains de-energized.

In position 4, the AC voltage across the secondary winding of T101 is rectified by both diodes D1 and D2, causing both relays RY1 and RY2 to energize. This allows the RF signal to be fed through relay RY1 lugs 6 and 4, and then through relay RY2 lugs 6 and 4 to antenna jack J4 (ANT 4).

Inductors L1, L101, and L102 serve to block RF from the DC switching lines. Capacitors C1, C106, and C107 prevent DC voltages from entering the transmitter and antenna lines. Inductor L101 and capacitors C104 and C105 make up a filter to help attenuate any low frequency RF that may be present at this point in the circuit.

Capacitors C4 and C6 in the remote unit serve to prevent relay chatter by filtering the voltages. Resistors R1, R2, R4, and R5 help bleed off any static charges that may be present on the respective antennas.

Capacitors C3 and C5 in the remote unit are used to maintain low insertion losses at higher operating frequencies.

SEMICONDUCTOR IDENTIFICATION CHART

DIODES

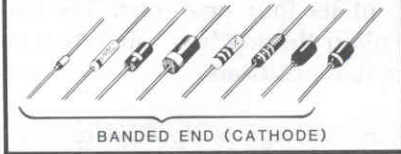
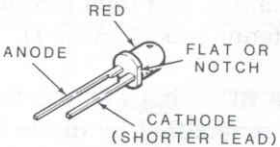
CIRCUIT COMPONENT NUMBER	HEATH PART NUMBER	MAY BE REPLACED WITH	IDENTIFICATION
D1, D2 D102, D103	57-27	1N2071	<p data-bbox="879 499 1278 552">IMPORTANT: THE BANDED END OF DIODES CAN BE MARKED IN A NUMBER OF WAYS.</p>  <p data-bbox="970 688 1203 709">BANDED END (CATHODE)</p>
D101	412-633	LED (Light-emitting diode)	 <p data-bbox="1034 758 1075 779">RED</p> <p data-bbox="951 800 1018 821">ANODE</p> <p data-bbox="1134 800 1219 821">FLAT OR NOTCH</p> <p data-bbox="1059 863 1225 905">CATHODE (SHORTER LEAD)</p>

CIRCUIT BOARD X-RAY VIEW

NOTE: To find the PART NUMBER of a component for the purpose of ordering a replacement part:

- A. Find the circuit component number (C1, R3, etc) on the X-Ray View.
- B. Locate this same number in the "Circuit Component Number" column of the "Parts List" (beginning on Page 0).
- C. Adjacent to the circuit component number, you will find the PART NUMBER and DESCRIPTION, which must be supplied when you order a replacement part.

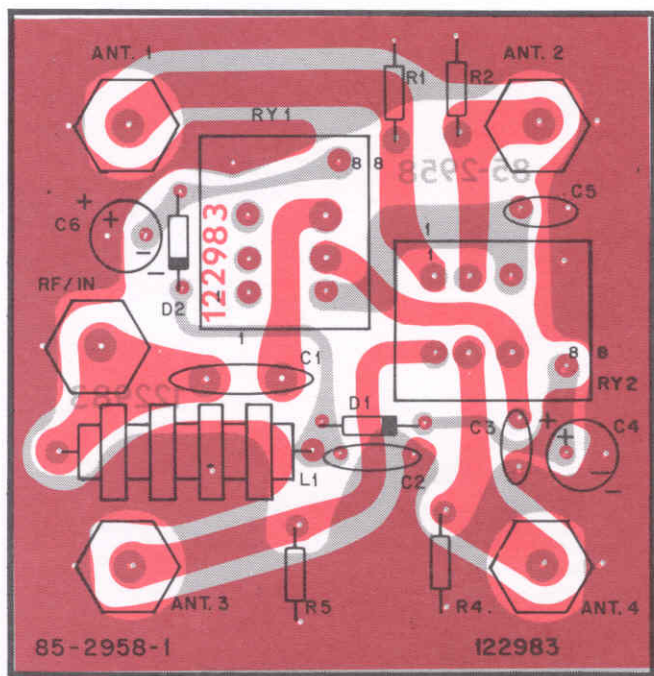

(Shown from the component side. The foil on the component side is shown in red.)

CUSTOMER SERVICE

REPLACEMENT PARTS

Please provide complete information when you request replacements from either the factory or Heath/Zenith Computers and Electronics centers. Be certain to include the **HEATH** part number exactly as it appears in the parts list.

ORDERING FROM THE FACTORY

Print all of the information requested on the parts order form furnished with this product and mail it to Heath. For telephone orders (parts only) dial 616 982-3571. If you are unable to locate an order form, write us a letter or card including:

- Heath part number.
- Model number.
- Date of purchase.
- Location purchased or invoice number.
- Nature of the defect.
- Your payment or authorization for COD shipment of parts not covered by warranty.

Mail letters to: Heath Company
Benton Harbor
MI 49022
Attn: Parts Replacement

Retain original parts until you receive replacements. Parts that should be returned to the factory will be listed on your packing slip.

OBTAINING REPLACEMENTS FROM HEATH/ZENITH COMPUTER AND ELECTRONICS CENTERS

For your convenience, "over the counter" replacement parts are available from the Heath/Zenith Computer and Electronics centers listed in your catalog. Be sure to bring in the original part and purchase invoice when you request a warranty replacement from a Heath/Zenith Computer and Electronics center.

TECHNICAL CONSULTATION

Need help with your kit? — Self-Service? — Construction? — Operation? — Call or write for assistance. You'll find our Technical Consultants eager to help with just about any technical problem except "customizing" for unique applications.

The effectiveness of our consultation service depends on the information you furnish. Be sure to tell us:

- The Model number and Series number from the blue and white label.
- The date of purchase.
- An exact description of the difficulty.
- Everything you have done in attempting to correct the problem.

Also include switch positions, connections to other units, operating procedures, voltage readings, and any other information you think might be helpful.

Please do not send parts for testing, unless this is specifically requested by our Consultants.

Hints: Telephone traffic is lightest at midweek — please be sure your Manual and notes are on hand when you call.

Heath/Zenith Computer and Electronics center facilities are also available for telephone or "walk-in" personal assistance.

REPAIR SERVICE

Service facilities are available, if they are needed, to repair your completed kit. (Kits that have been modified, soldered with paste flux or acid core solder, cannot be accepted for repair.)

If it is convenient, personally deliver your kit to a Heath/Zenith Computers and Electronics center. For warranty parts replacement, supply a copy of the invoice or sales slip.

If you prefer to ship your kit to the factory, attach a letter containing the following information directly to the unit:

- Your name and address.
- Date of purchase and invoice number.
- Copies of all correspondence relevant to the service of the kit.
- A brief description of the difficulty.
- Authorization to return your kit COD for the service and shipping charges. (This will reduce the possibility of delay.)

Check the equipment to see that all screws and parts are secured. (Do not include any wooden cabinets or color television picture tubes, as these are easily damaged in shipment. Do not include the kit Manual.) Place the equipment in a strong carton with at least **THREE INCHES** of *resilient* packing material (shredded paper, excelsior, etc.) on all sides. Use additional packing material where there are protrusions (control sticks, large knobs, etc.). If the unit weighs over 15 lbs., place this carton in another one with 3/4" of packing material between the two.

Seal the carton with reinforced gummed tape, tie it with a strong cord, and mark it "Fragile" on at least two sides. Remember, the carrier will not accept liability for shipping damage if the unit is insufficiently packed. Ship by prepaid express, United Parcel Service, or insured Parcel Post to:

Heath Company
Service Department
Benton Harbor, Michigan 49022

Heath Company
Benton Harbor, Michigan

The bottom half of the page features a decorative design consisting of three horizontal stripes. The top stripe is dark blue, the middle stripe is white, and the bottom stripe is a lighter blue. These stripes are separated by thin white lines.