

Assembly and Operation of the



RF POWER METER MODEL HM-102

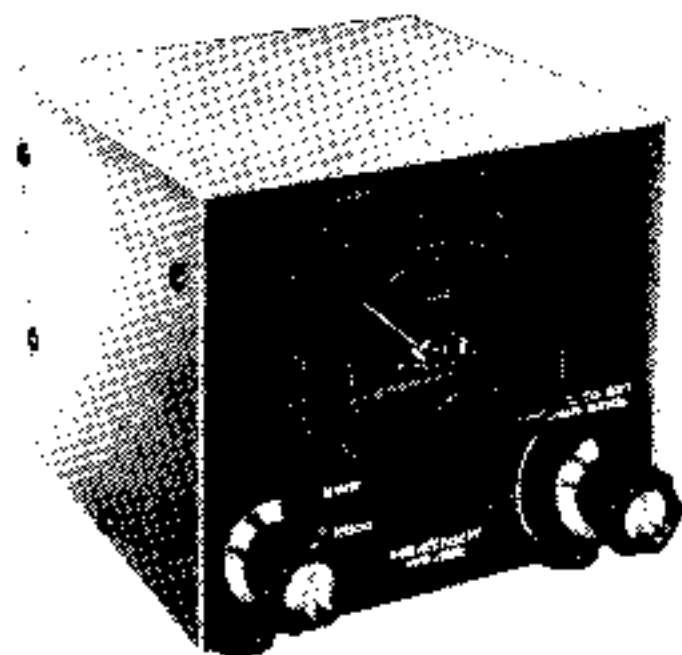

TABLE OF CONTENTS

Introduction	2
Parts List	2
Step-by-Step Assembly	4
Circuit Board Assembly	4
Remote Chassis Assembly	7
Cabinet Assembly	10
Cabinet Wiring	12
Calibration	13
Operation	16
In Case of Difficulty	18
Troubleshooting Chart	19
Specifications	21
Circuit Description	22
Circuit Board X-Ray View	22
Remote Chassis Photo	23
Cabinet Photo	23
Schematic. . . (fold-out from Page)	23
Replacement Parts Price List	24
Warranty	Inside front cover
Customer Service	Inside rear cover

HEATH COMPANY
BENTON HARBOR, MICHIGAN 49022

INTRODUCTION

The Heathkit Model HM-102 RF Power Meter is a reliable instrument for measuring the RF power output and the SWR (VSWR) of an amateur radio station or other similar types of transmitting systems. The Power Meter can be permanently installed in the transmission line without affecting the transmitting and receiving capabilities of your station.

The Power Meter aids proper transmitter tuning as the meter indicates maximum forward power when the transmitter is tuned for maximum output. At the SWR setting, the meter measures the mismatch between the transmission line connected to the input terminal and the load connected to

the output terminal. This information is of great value in making antenna adjustments and in determining the allowable frequency working range of the antenna.

This unit is designed for use only with a transmission line of 50 Ω nominal characteristic impedance. It has negligible insertion loss. The indicating meter is mounted in a small cabinet for use at the operating position. For convenience, the detector portion may be removed and positioned up to six feet away with the cable supplied. No external power is required.

PARTS LIST

Check each part against the following parts list. The key numbers correspond to the numbers in the Parts Pictorial (fold out from Page 3). NOTE: When more than one number is on a package, disregard all but the part number as listed below.

To order a replacement part, use the Parts Order Form furnished with this kit. If a Parts Order Form is not available, refer to "Replacement Parts" inside the rear cover of the Manual.

KEY PART No.	PARTS No.	PARTS Per Kit	DESCRIPTION
RESISTORS			
1/2-Watt, 5%			
1	1-157	2	470 Ω (yellow-violet-brown)
	1-122	1	3300 Ω (orange-orange-red)
	1-58	1	22 k Ω (red-red-orange)
	1-159	1	82 k Ω (gray-red-orange)
	1-104	1	100 k Ω (brown-black-yellow)
Other Resistors			
2	1-16-1	1	68 Ω , 1-watt, 10% (blue-gray-black)
3	2-41	1	90 k Ω , 1/2-watt, precision

KEY PART No.	PARTS No.	PARTS Per Kit	DESCRIPTION
CAPACITORS			
4	20-148	2	100 pF mica
5	21-181	1	7.7 pF ceramic
	21-11	2	150 pF ceramic
	21-140	9	.001 μ F ceramic
	21-27	2	.005 μ F ceramic
6	31-57	1	2.7-20 pF trimmer

KEY PART No.	PARTS No.	PARTS Per Kit	DESCRIPTION
CONTROLS			
7	10-325	1	50 k Ω
8	19-153	1	200 k Ω with switch (appearance may vary)

KEY PART			DESCRIPTION				KEY PART			DESCRIPTION			
No.	No.	Per Kit					No.	No.	Per Kit				
INDUCTORS-DIODE-SWITCHES						METAL PARTS							
9	40-1011	1	Toroid coil				30	90-503-1	1	Cabinet top			
10	56-20	3	1N295 diode (red-white-green)				31	90-504-1	1	Cabinet chassis			
11	60-53	1	Slide switch				32	214-116	1	Remote chassis cover			
12	63-47	1	3-position rotary switch				33	214-115-2	1	Remote chassis			
HARDWARE						MISCELLANEOUS							
#4 Hardware						35	75-30	1	Strain relief				
13	250-213	8	4-40 x 5/16" screw					75-93	1	1" square insulator paper			
14	252-15	8	4-40 nut					85-1443-1	1	Circuit board			
15	254-9	8	#4 lockwasher				36	207-5	1	Cable clamp			
#6 Hardware						37	261-9	4	Rubber foot				
16	250-170	8	#6 x 1/4" sheet metal screw				38	407-155	1	Meter			
	250-369	8	#6 x 1/4" black sheet metal screw				39	436-5	2	SO-239 connector			
17	250-56	6	8-32 x 1/4" binder head screw				40	462-191	2	Knob			
18	250-162	5	6-32 x 1/2" binder head screw				41	490-5	1	Nut starter			
19	252-3	5	6-32 nut				42	475-10	5	Ferrite bead			
20	253-89	1	D-washer				43	391-34	1	Blue and white label			
21	254-1	10	#6 lockwasher					340-3	1	Bare wire			
22	259-1	1	#6 solder lug					346-21	1	Teflon* sleeving			
Other Hardware							347-39	1	5-conductor cable				
23	250-43	2	8-32 x 1/4" setscrew					597-260	1	Parts Order Form			
24	252-7	2	Control nut					597-308	1	Kit Builders Guide			
25	253-10	2	Control flat washer						1	Assembly Manual (See front cover for part number.)			
26	254-35	1	Control lockwasher							Solder			
27	255-30	1	Control spacer				*DuPont Registered Trademark.						
28	255-71	3	6-32 x 3/4" threaded spacer										
29	257-12	1	Eyelet										

CALIBRATION

Before calibrating the Meter, prepare an alignment tool in the following manner: Locate the small 1/8" x 3/4" alignment tool blade. Refer to Figure 1 and install the blade into the small end of the nut starter as shown. Leave 1/8" of the blade protruding from the end of the alignment tool.

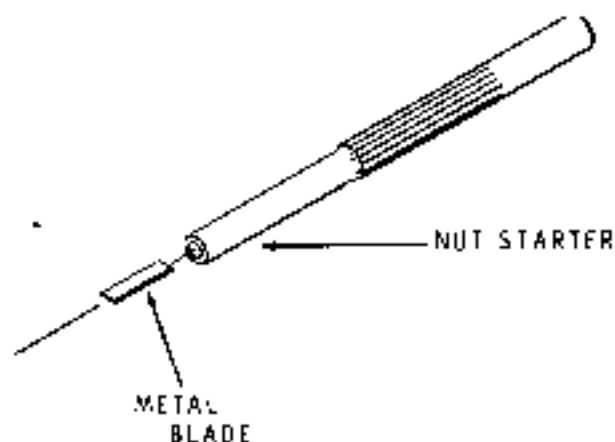

Figure 1

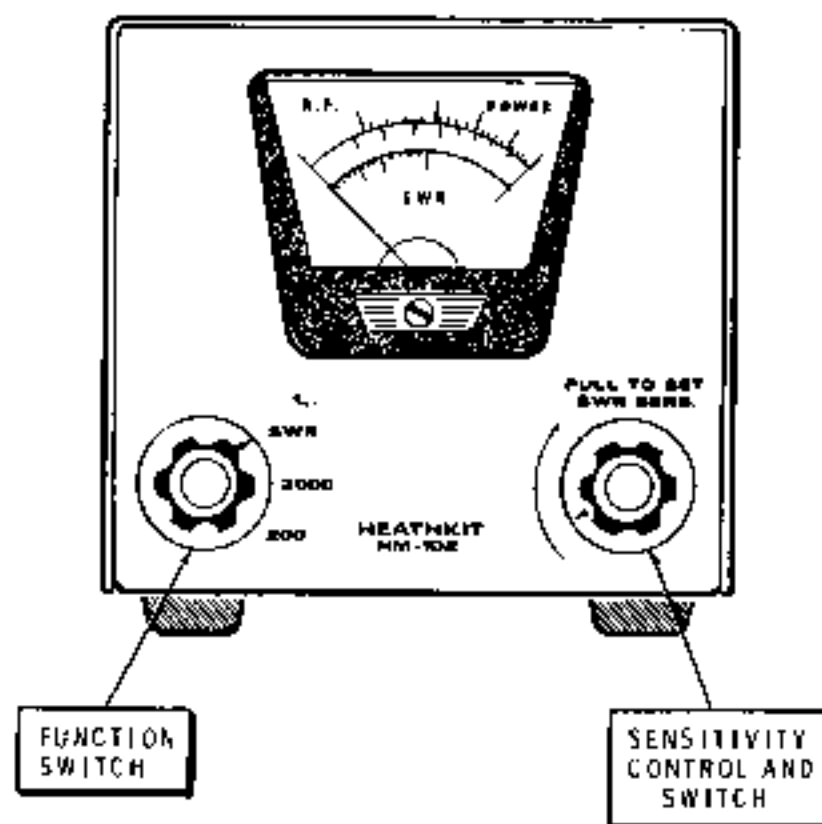

Figure 2

NOTE: During the following steps, the remote cabinet may be placed so you can easily make the adjustments while watching the meter.

SWR BALANCE ADJUSTMENT

NOTE: Perform steps 1 through 8 to make sure you have a normal output from your transmitter, through the meter, to your dummy load. You must obtain a reading on the RF Power Meter scale before continuing with steps 9 through 15.

1. (✓) Check to see that the meter needle is directly over the zero on the scale. If it is not, adjust the screw head on the meter case slightly to position the needle over the zero.
2. (✓) Connect a 50-ohm noninductive load, such as the Heathkit Antenna, to the remote chassis OUTPUT jack. (See Figure 3 on Page 14).
3. (✓) Connect the transmitter output to the INPUT jack on the remote chassis. (See Figure 3.)
4. (✓) Set the FUNCTION switch to 200. (See Figure 2.)
5. (✓) Push the SWR SENS control knob in and turn the control fully counterclockwise.
6. (✓) Set the CALIBRATION switch, on the rear of the remote chassis, to NORM (see Figure 3).
7. (✓) Turn on the transmitter, and set it to the CW mode in the 40-meter band. Then tune the transmitter and watch the RF Power Meter needle move up-scale. If the meter needle does not move up-scale, refer to the "In Case of Difficulty" section of this Manual.
8. (✓) Turn the Transmitter output level down.
9. (✓) Set the FUNCTION switch to SWR.
10. (✓) Increase the transmitter output level until a reading of approximately 25 is seen on the 200 RF Power Meter scale. Even if the meter reading is not this high, proceed with the following steps.
11. (✓) With the SWR SENS control knob still pushed in, set it for a full-scale reading.
12. (✓) Refer to Figure 3, and adjust SWR NULL trimmer C4, through the rear of the remote chassis, with the alignment tool (nut starter) for the best null or greatest dip of the meter needle. This reading should be at or near zero. NOTE: Do not use any metal tool other than the nut starter blade to make these adjustments.

13. (✓) Increase the transmitter output to full power and readjust SWR NULL trimmer C4. Make this final adjustment carefully and precisely. The accuracy of the instrument depends on a well-balanced bridge circuit.
14. (✓) Repeat steps 12 and 13.
15. (✓) After removing the paper backing place the 1" square insulator paper over the hole to trimmer C4. This adjustment must not be disturbed during the following steps.

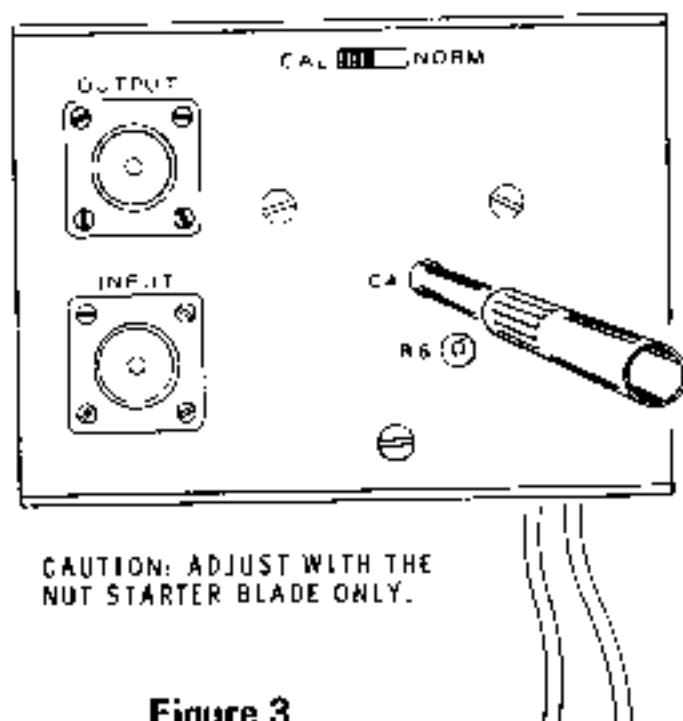

Figure 3

Do not disconnect the RF Power Meter, the transmitter, or the load; they will be used in the following section.

POWER METER

This section of the Manual contains two calibration procedures: one for calibrating the RF Power Meter on the 40-meter band, and one for calibrating the Meter on any one of the other bands.

For maximum accuracy, the Meter should be calibrated on the 40-meter band, even if it is going to be used on the other bands. Therefore, if your transmitter will tune to the 40-meter band, use the "Normal Calibration" procedure to calibrate your Meter. However, if your transmitter will not tune to the 40-meter band, use the "Calibration on Other Bands" procedure. Since the meter readings are more accurate in the upper-half of the meter scale, it is desirable to use a transmitter that is capable of delivering at least 100 watts of output power for either calibration procedure.

Normal Calibration

- () Turn the FUNCTION switch to 200.
- () Adjust the transmitter output to 100 watts.
- () Complete the calibration as follows:
 1. Set the CALIBRATE switch on the remote chassis to CAL and note the meter reading.
 2. Now set the CALIBRATE switch to NORM.
 3. Adjust POWER CALIBRATE control R6 with the alignment tool so the meter reads the same as noted in step 1.
 4. Repeat steps 1 through 3 until the meter readings for the CAL and NORM switch positions are the same.

Leave the CALIBRATE switch in the NORM position.

This completes the calibration of your RF Power Meter.

Calibration on Other Bands

NOTE: During the following steps you will need a VTVM with a high impedance input and an RF probe, or an RF voltmeter to measure the RF output of your transmitting system.

If you cannot tune your transmitter to the 40-meter band, acceptable calibration accuracy can be obtained on another band by using the following power formula:

$$P = \frac{E^2}{R}$$

Where P = watts output

E = RF voltage across the load

R = load resistance

To determine E, measure the RF voltage across the 50-ohm resistive load (Antenna) with an RF voltmeter or a VTVM equipped with an RF probe.

With this method, the watts output determined by the formula is compared with the watts reading on the scale of the Power Meter. The Power Meter is then adjusted to read the same as the power determined by the formula.

EXAMPLE: If you wish to use the 25-watt figure on the meter scale for calibration and you are using a 50-ohm resistive load, set your transmitter output so the RF voltmeter across the load reads 35-volts RF.

$$25 \text{ watts (P)} \times 50 \text{ ohms (R)} = 1250 \text{ (E}^2\text{)}$$

$$E = \sqrt{1250} = 35 \text{ volts (approximately)}$$

When the RF voltmeter indicates 35 volts, you know the transmitter is putting out 25 watts; therefore, you can adjust the RF Power Meter to indicate 25 watts.

Any other figure for watts between 10 and 2000 may be substituted in the formula and in the example.

If you have an accurate RF wattmeter, adjust R6 to the same reading as shown on the wattmeter.

1. () Select the power you wish to obtain from your transmitter.
2. () Use the power formula to calculate the RF voltage that should appear across the resistive load when the transmitter is putting out the selected power (refer to the example).
3. () Turn the FUNCTION switch to 200 or 2000, depending upon the output power of your transmitting system.
4. () Connect the RF voltmeter across the resistive load. **NOTE:** Do not exceed the current rating of your RF probe.
5. () Adjust the transmitter output so the RF voltage across the resistive load is the same as the calculated RF voltage.
6. () Adjust control R6 through the rear of the remote chassis so the RF Power Meter indicates the power you selected to obtain from the transmitter.

This completes the calibration of your RF Power Meter.

FINAL ASSEMBLY

Refer to Pictorial 9 for the following steps.

NOTE: In the following steps, the remote chassis will be installed in the cabinet. If you wish to place the remote chassis in some location away from the cabinet, so the remote unit will be near the transmission lines, do not complete the following steps. In this case, place the four black screws in a small envelope and tape them to the floor of the cabinet.

- () Position the remote chassis inside the top rear opening of the cabinet. Secure the remote chassis to the cabinet with four #6 x 1/4" black sheet metal screws.
- () Tighten the remaining four black cabinet screws.
- () Coil the 5-conductor remote cable neatly and slide it into the opening beneath the remote unit.
- () Turn the cabinet upside down. Remove the paper backing from the blue and white label; then, press the label firmly onto the bottom of the cabinet as shown on Pictorial 8 (fold-out from this Page).

This completes the step-by-step assembly of your RF Power Meter.

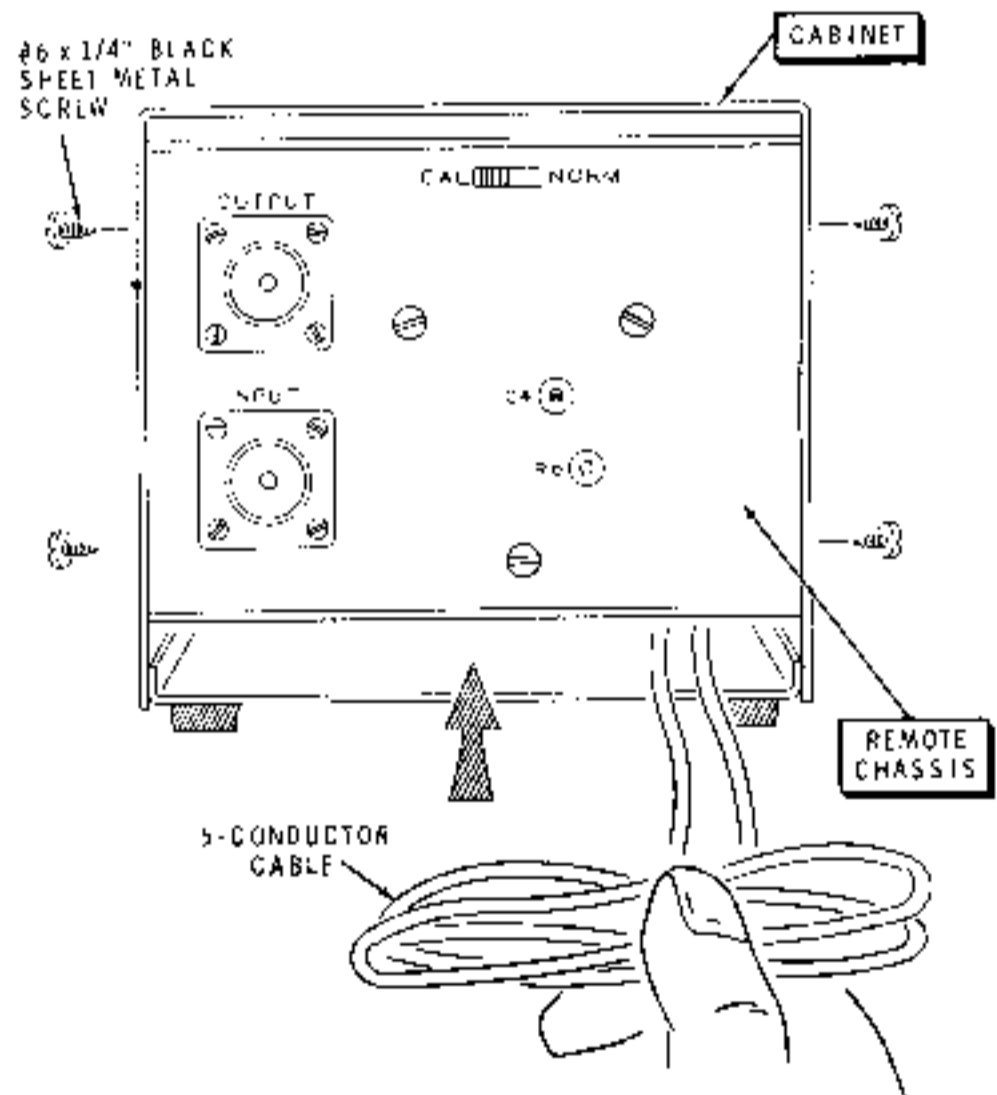

PICTORIAL 9

OPERATION

SWR METER

NOTE: The RF power meter SWR bridge can only be used with 50 ohm nominal transmission lines. Also it will not work on transmission lines that are used as tuned feeders, since tuned feeders normally have a high SWR.

1. Turn the FUNCTION switch to SWR.
2. Pull the SWR SENS switch out and turn it fully counterclockwise.
3. Apply power to the transmitter and tune it for maximum RF output reading. Disregard the Power Meter readings at this time.
4. Turn the SWR SENS control clockwise for a midscale meter reading. A minor "touch-up" tuning of the transmitter may show an increase on the Meter. This indicates a closer match between the transmitter and the transmission line.
5. Turn the SWR SENS control clockwise to give a full-scale meter reading.
6. Push the SWR SENS control knob in and read the SWR ratio directly on the lower meter scale.

Normal Operating Characteristics

The Power Meter (SWR Bridge) may be left in the transmission line at all times for continuous monitoring purposes.

The peaks on controlled carrier modulation will "kick" the meter needle upward. SSB and DSB signals will give a bouncing indication when transmitting; so no SWR measurement can be made with these signals. Therefore, use a single-tone or CW carrier with sideband transmitters when taking readings. When operating SSB, any indication with no modulation indicates spurious or parasitic emission, or poor carrier suppression.

Physical Placement and Losses

The detector unit may be removed from the cabinet and placed at a location more convenient for connection to your transmission line. The 6' interconnecting cord that is furnished may be replaced by a longer one, if this is desired. You may even position the detector unit at the antenna, although there is always the possibility of RF pickup on the extended interconnecting cable from the transmission line. If this should occur, the use of properly grounded, shielded interconnecting cable may be required. **NOTE:** The remote cabinet is not weatherproofed. Any outdoor application should be temporary.

The SWR meter readings may vary if the Meter is placed at different locations in the transmission line, or if the length of the transmission line is changed. For this reason, assume that the highest SWR reading is most correct. Keep in mind that the closer the SWR approaches 1:1, the more accurate the Power Meter becomes.

Misleading readings may be obtained with long transmission lines since the losses in the cable tend to "smooth out" the standing waves, giving a much better indication at the transmitter than actually exists at the antenna. Therefore, if you are using a transmission line long enough to have appreciable losses, locate the Power Meter near the antenna, especially when adjusting beams or tuning traps. You can better understand the extent of this effect when you realize that a line with a 3 dB loss will show an SWR of 3 when it is terminated in a dead short. A line with a loss of over 10 dB will show an SWR of practically 1:1, on this or any other SWR meter, regardless of what load or termination is connected at the far end.

The power losses in these cases are occurring in the cable, but the SWR meter reading will not indicate that anything is wrong. When in doubt, make measurements at the antenna and at the transmitter, so future changes in the readings will be meaningful. The values of cable losses at various frequencies can be obtained from Figure 4. These losses become worse as time and moisture affect the cable.

With a high SWR, the transmission line losses may become so great that the radiated power is appreciably reduced; with high-power transmitters, the cable ratings may be exceeded. Figure 5 shows the effect of increasing cable losses caused

by various values of SWR. When these losses occur, the RF power is turned into heat in the cable instead of being radiated from the antenna.

To obtain total losses in a given length of coaxial cable, determine the dB loss per foot of the cable from Figure 4. This is done by finding your operating frequency on the bottom line of the chart, and moving up to find the type of cable used. By looking at this same level on the left-hand side of the chart, you can read the dB loss per 100 feet of the cable at that frequency.

Now determine the additional loss caused by the SWR from Figure 5 as follows: Use the amount of loss determined from Figure 4 and find this value on the bottom line of Figure 5. Now move up the graph until you come to the SWR of your antenna system. Move over to the left-hand side of the graph and determine the amount of loss caused by the SWR. To obtain the total loss of your system, add the value from Figure 4 to the value from Figure 5. Multiply the total loss by the cable length in feet. Then divide by 100.

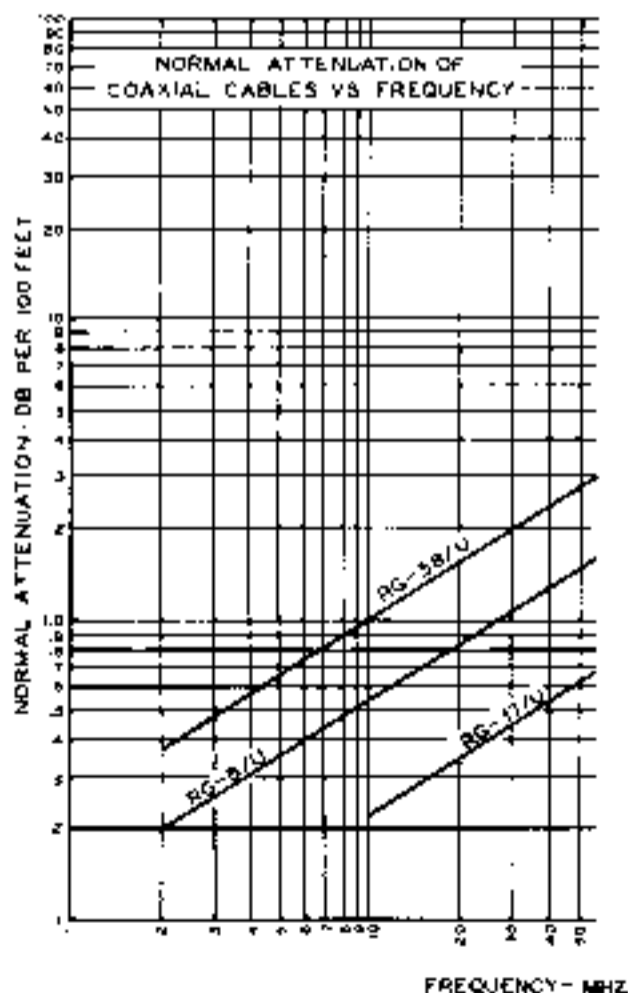

Figure 4

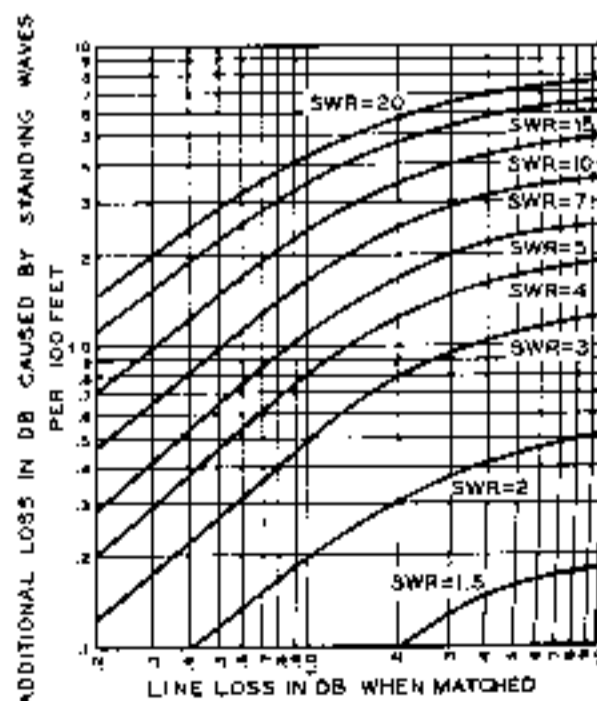

Figure 5

Loading

The load presented to the transmitter output circuit may create conditions that make it touchy or impossible to load the transmitter. With a low SWR, the load that the transmitter sees is practically pure resistive. However, at a high SWR, the apparent load may change from a very low to a very high resistance, accompanied by either capacitive or inductive reactance. These resistance and reactance values change when the transmission line length or frequency is changed.

Remember when you are using 50 Ω nominal unbalanced feed lines that the SWR cannot be changed by changing the transmission line length. However, the loading to the transmitter may be changed considerably; thus making it appear that "pruning" the cable length offers improvement, when it actually does not affect the SWR.

The SWR can only be changed by changing the load or termination at the end of the cable. If the transmission line length is changed, for example, with 50 Ω cable and an SWR of 3, the apparent load to the transmitter may vary from 16-2/3 Ω to 150 Ω resistive in series with reactance varying from 66-2/3 Ω capacitive, to zero, to 66-2/3 Ω inductive. If

the transmitter output tuning adjustments will not accommodate this impedance range, the transmitter will be difficult to load until the load is properly matched to the line. When the load is matched, the SWR will be low, approaching 1:1.

POWER METER

The operation of the Power Meter is relatively uncomplicated. Merely place the FUNCTION switch in either the 200- or 2000-watt position; then read the corresponding scale on the meter scale to obtain the power output of the transmitter. A load must be connected to the output jack of the Meter.

Low Power Measurements (1 to 20 Watts)

1. Place the Function switch at 200.
2. Increase the transmitter output to 10 on the 200 scale.
3. Turn the Function switch to SWR.
4. Pull out the SWR SENS switch and adjust the meter reading to 100 on the 200 scale.
5. Read from 0 to 20-watts directly from the 200 scale providing the SWR SENS control is not touched.

IN CASE OF DIFFICULTY

1. Recheck the wiring. Trace each lead in colored pencil on the Pictorial as it is checked. It is frequently helpful to have a friend check your work. Someone who is not familiar with the unit may notice something consistently overlooked by the constructor.
2. It is interesting to note that about 90% of the kits that are returned for repair, do not function properly due to poor connections and soldering. Therefore, many troubles can be eliminated by reheating all connections to make sure that they are soldered as described in the "Soldering" section of the "Kit Builders Guide."
3. Check the values of parts. Be sure that the proper part has been wired into the circuit, as shown in the

Pictorial diagrams and as called out in the wiring instructions.

4. Check for bits of solder, wire ends, or other foreign matter which may be lodged in the wiring.
5. A review of the Circuit Description and the Schematic Diagram may prove helpful in locating a trouble.

NOTE: In an extreme case where you are unable to resolve a difficulty, refer to the "Customer Service" information inside the rear cover of the Manual. Your Warranty is located inside the front cover of the Manual.

Troubleshooting Chart

PROBLEM	POSSIBLE CAUSE
Meter reads down-scale on SWR or wattmeter.	<ol style="list-style-type: none">1. Meter leads reversed.2. Diode D1 or D2 reversed.
Higher meter reading for SWR Set than for SWR.	<ol style="list-style-type: none">1. Input and output plugs reversed.2. Pickup coil L1 leads reversed.3. Switch S3 incorrectly wired.
Calibrator portion of meter not functioning correctly.	<ol style="list-style-type: none">1. Input and output plugs reversed.2. Diode D3 reversed.3. Capacitor C7, C8, C11, or C9.4. Resistor R5.
SWR reading while transmitter is off.	<ol style="list-style-type: none">1. Nearby transmitter in operation.

SPECIFICATIONS

Frequency Range	1.8 to 30 MHz.
Wattmeter Accuracy	±10% of full-scale reading.*
Power Capability	To 2000 watts.
SWR Sensitivity	Less than 10 watts.
Impedance	50 ohms nominal.
SWR Bridge	Continuous to 2000 watts P-P.
Connectors	UHF type SO-239.
Dimensions	5-1/4" wide, 5-1/16" high, and 6-1/2" deep, assembled as one unit.
Net Weight	2-1/2 lbs.

*Using a 50 Ω noninductive load.

The Heath Company reserves the right to discontinue products and to change specifications at any time without incurring any obligation to incorporate new features in products previously sold.

CIRCUIT DESCRIPTION

Refer to the Schematic (fold-out from Page 23) while reading this "Circuit Description."

SWR BRIDGE CIRCUIT

Toroid coil L1 is a current pickup element for forward and reflected power. A bus wire is routed from the Input jack through toroid coil L1, and then to the Output jack. A transmitted signal routed along this wire induces a current in coil L1. The voltage formed in coil L1 is rectified by diode D3 and decoupled by capacitor C5 and resistor R4. Resistor R3 creates a load for forward power readings. Reverse power readings are determined, in the same manner, by the circuit consisting of diode D2, capacitor C2, and resistor R1.

Forward and reverse voltages are connected to the meter through switch S2, Sensitivity control R11, and Function switch S3.

Resistor R7 is a ground-return path for diodes D2 and D3. Capacitors C4, C12, C13, and C1 form a voltage divider circuit to balance the capacitive effects of the bifilar (doubled) windings in coil L1, which provides correct SWR readings.

POWER METER CIRCUIT

Current is induced in toroid coil L1 in the same manner as for the SWR bridge circuit. Resistor R2 forms a load across coil L1 to reduce the Q of the coil circuit. This prevents the transmitted frequency from affecting the wattmeter.

The wattmeter is calibrated by measuring the voltage at control R6, which varies the power going to the meter. Resistors R8 and R9 are voltage dividers for the two power ranges: 200 watts and 2000 watts.

Capacitors C7 and C8, diode D1, and voltage divider resistor R5 through switch S1 complete a voltmeter circuit for the wattmeter.

By using an accurate device, such as an RF probe with a VTVM or a wattmeter calibrator, this Power Meter can be calibrated to a desired degree of accuracy.

Ferrite beads L2 through L6 prevent RF from traveling through the 5-conductor cable into the readout circuits.

CIRCUIT BOARD X-RAY VIEW

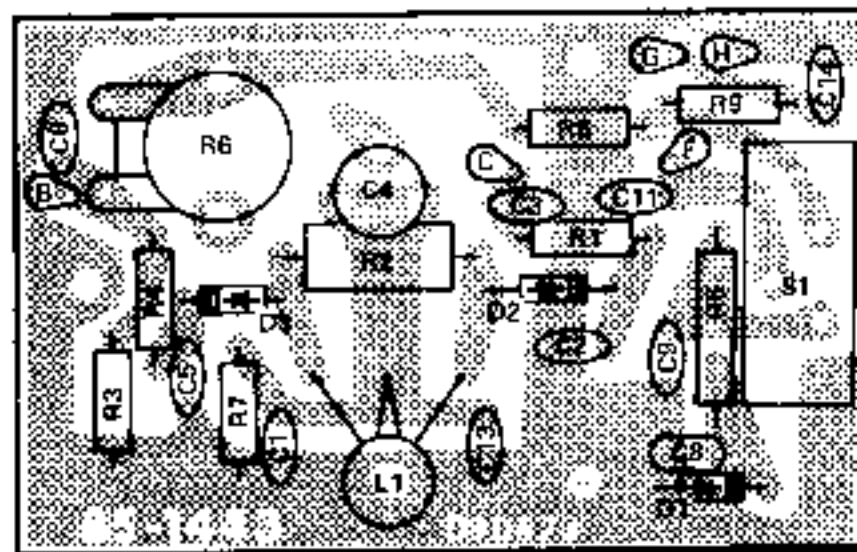

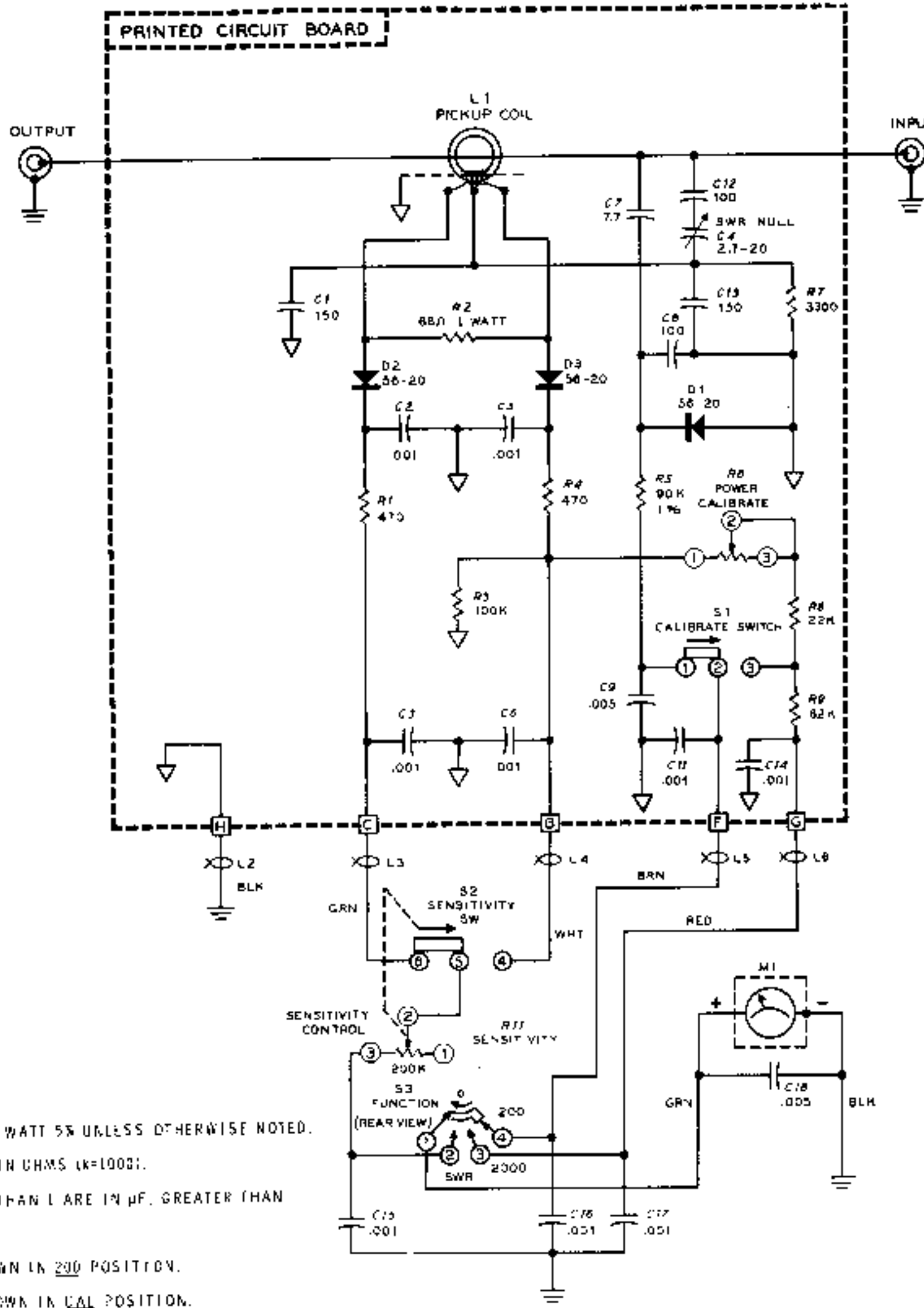

NOTES-

1. ALL RESISTORS ARE 1/2 WATT 5% UNLESS OTHERWISE NOTED. RESISTOR VALUES ARE IN OHMS (K=1000).
2. ALL CAPACITORS LESS THAN 1 ARE IN μ F. GREATER THAN 1 ARE IN nF.
3. FUNCTION SWITCH SHOWN IN 200 POSITION.
4. CALIBRATE SWITCH SHOWN IN CAL POSITION.
5. SENSITIVITY SWITCH SHOWN PUSHED IN.
6. THIS SYMBOL INDICATES CIRCUIT BOARD COMMON.
7. THIS SYMBOL INDICATES CHASSIS GROUND.
8. THIS SYMBOL INDICATES AN EXTERNAL CONNECTION TO THE CIRCUIT BOARD.
9. THIS SYMBOL INDICATES A FERRITE BEAD.

SCHEMATIC OF THE HEATHKIT[®]

RF POWER METER MODEL HM-102