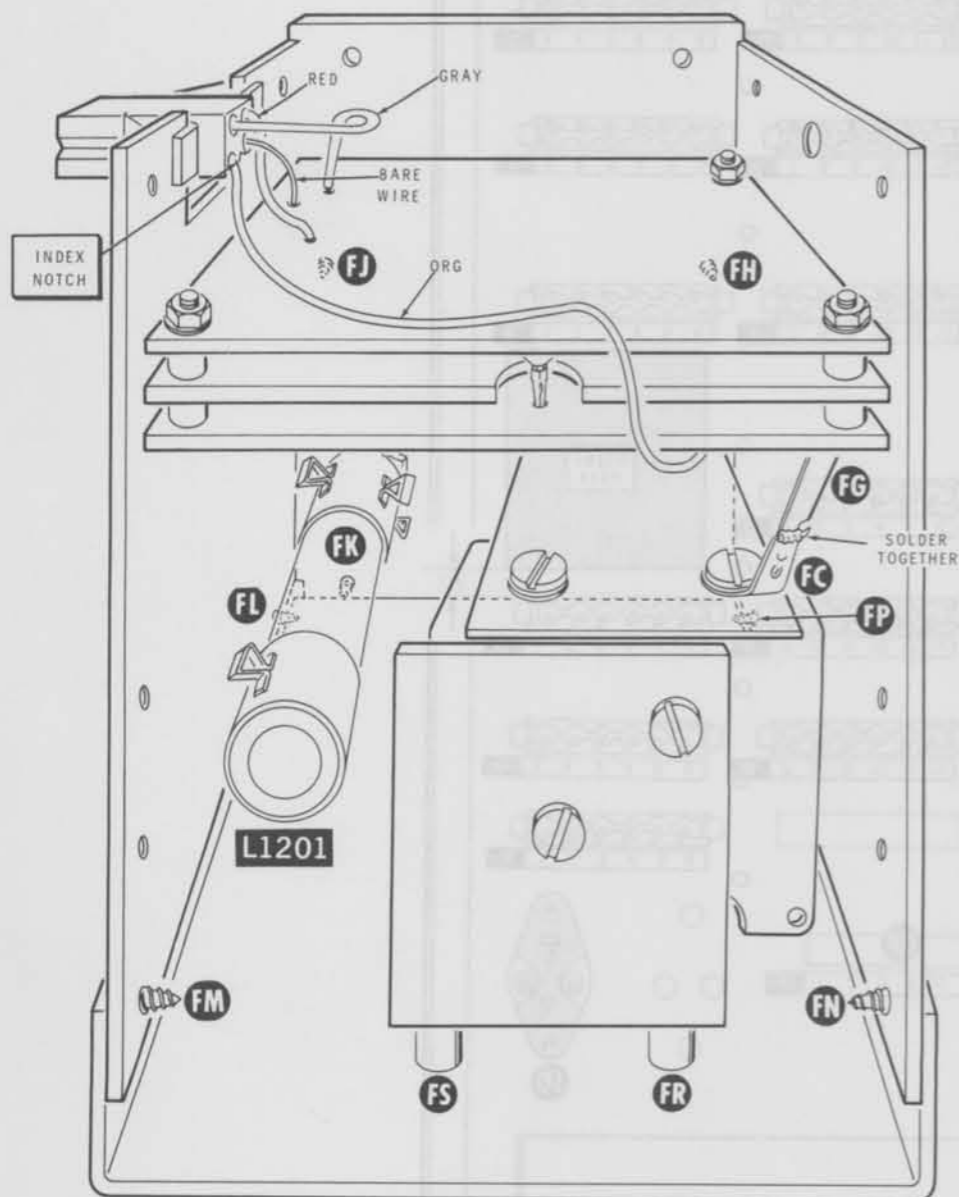
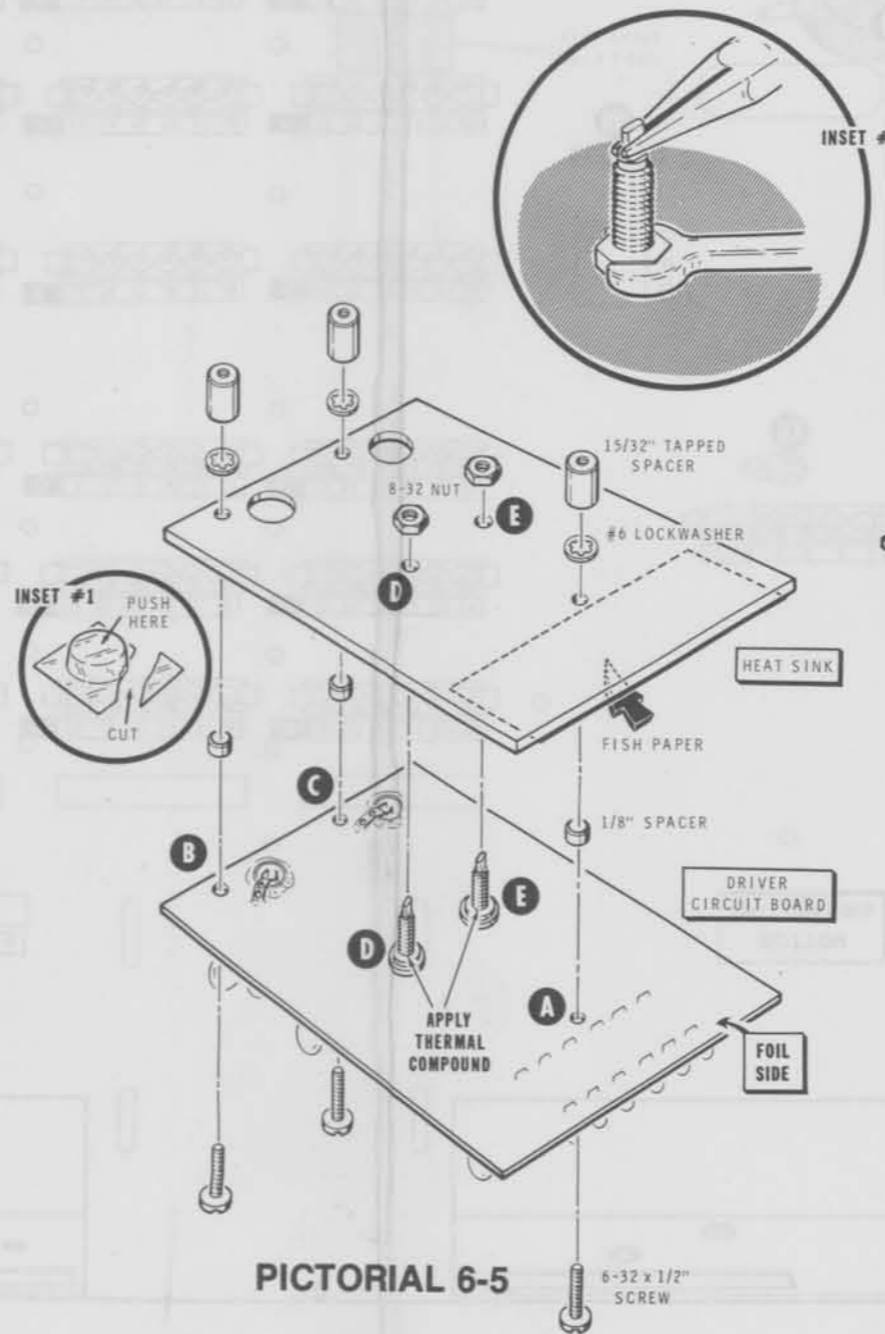

ILLUSTRATION BOOKLET

Part of 595-1755-01



PICTORIAL 1-12



PICTORIAL 6-5

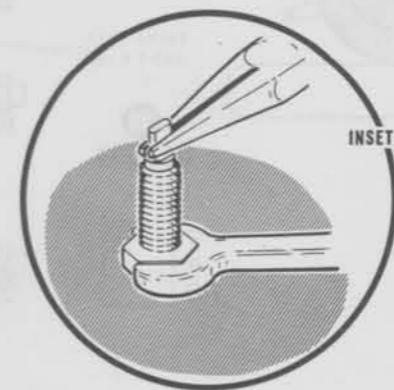

INSET #2



INSET #1

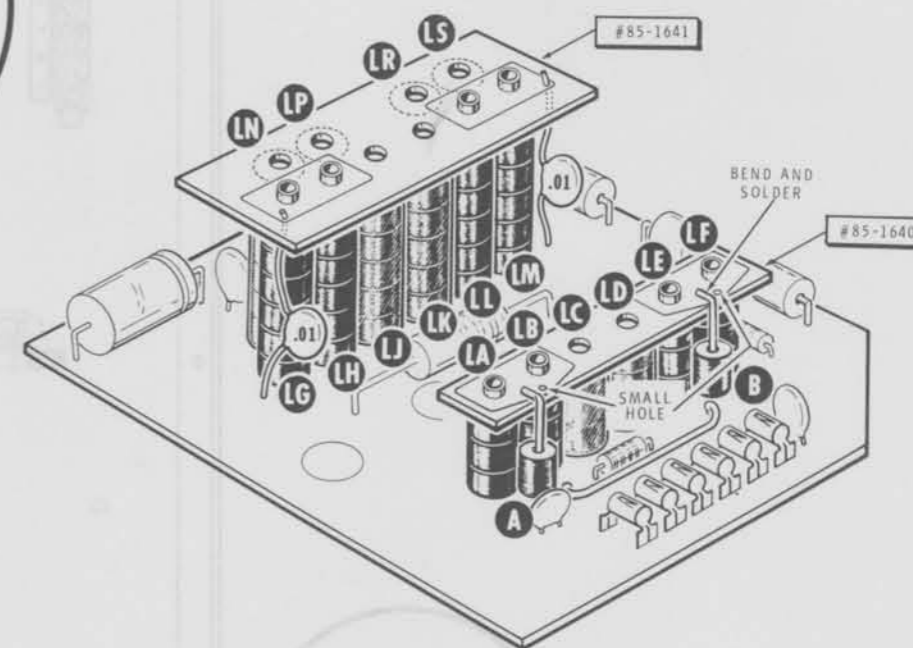

PICTORIAL 11-5

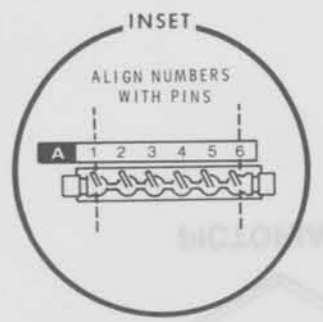
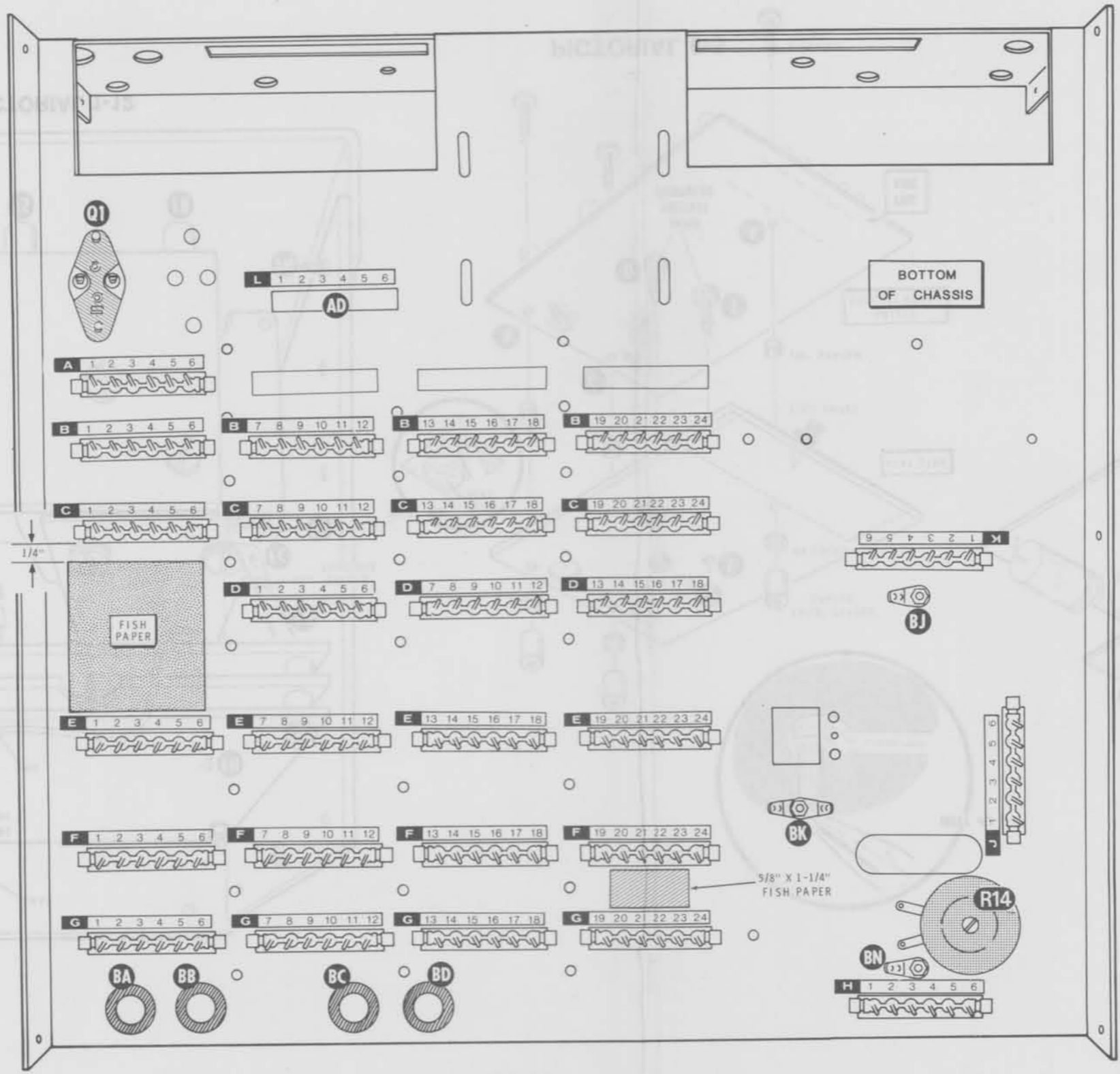

PICTORIAL 12-1

51C10MVF 15-3

51C10MVF 15-4

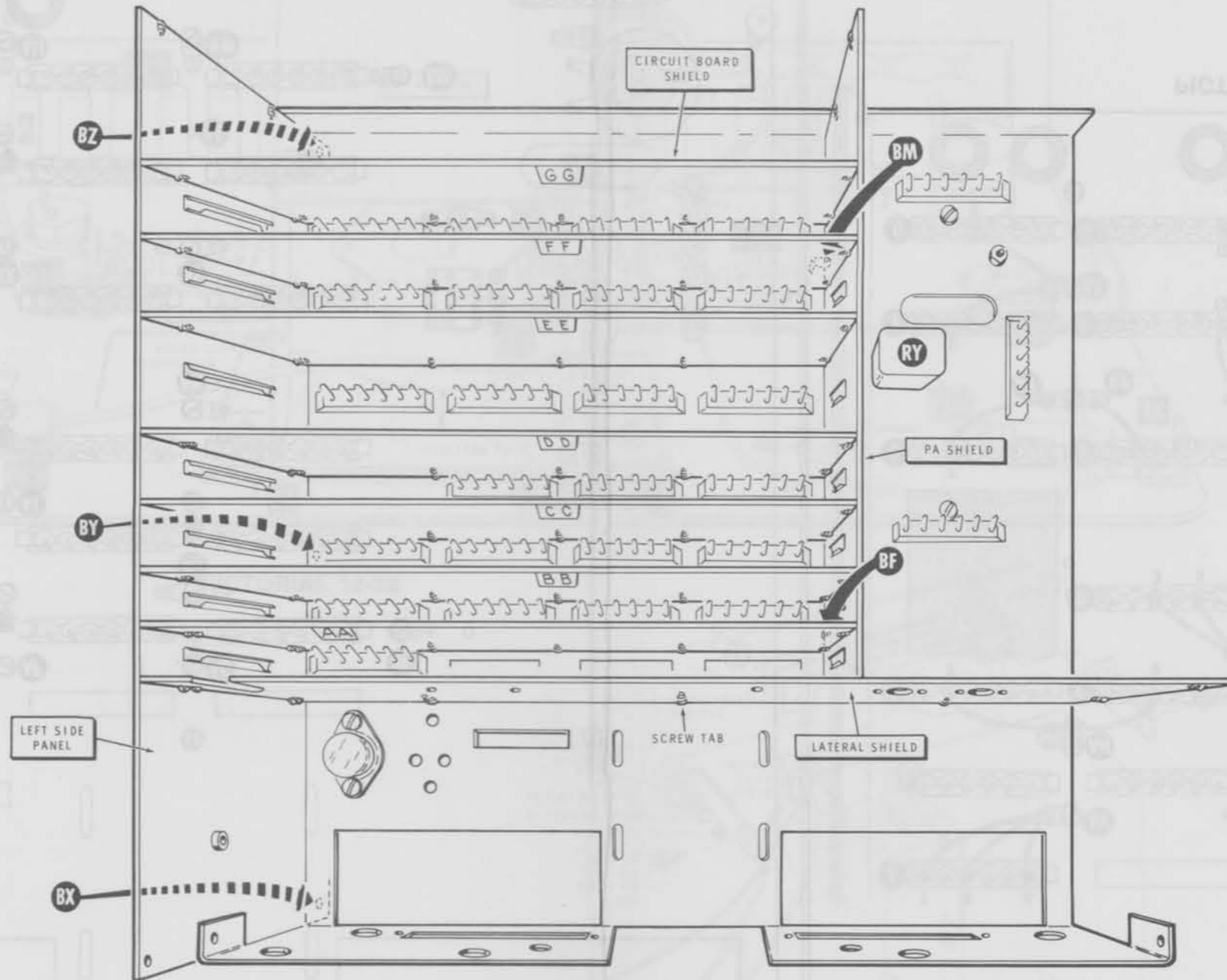

PICTORIAL 12-2

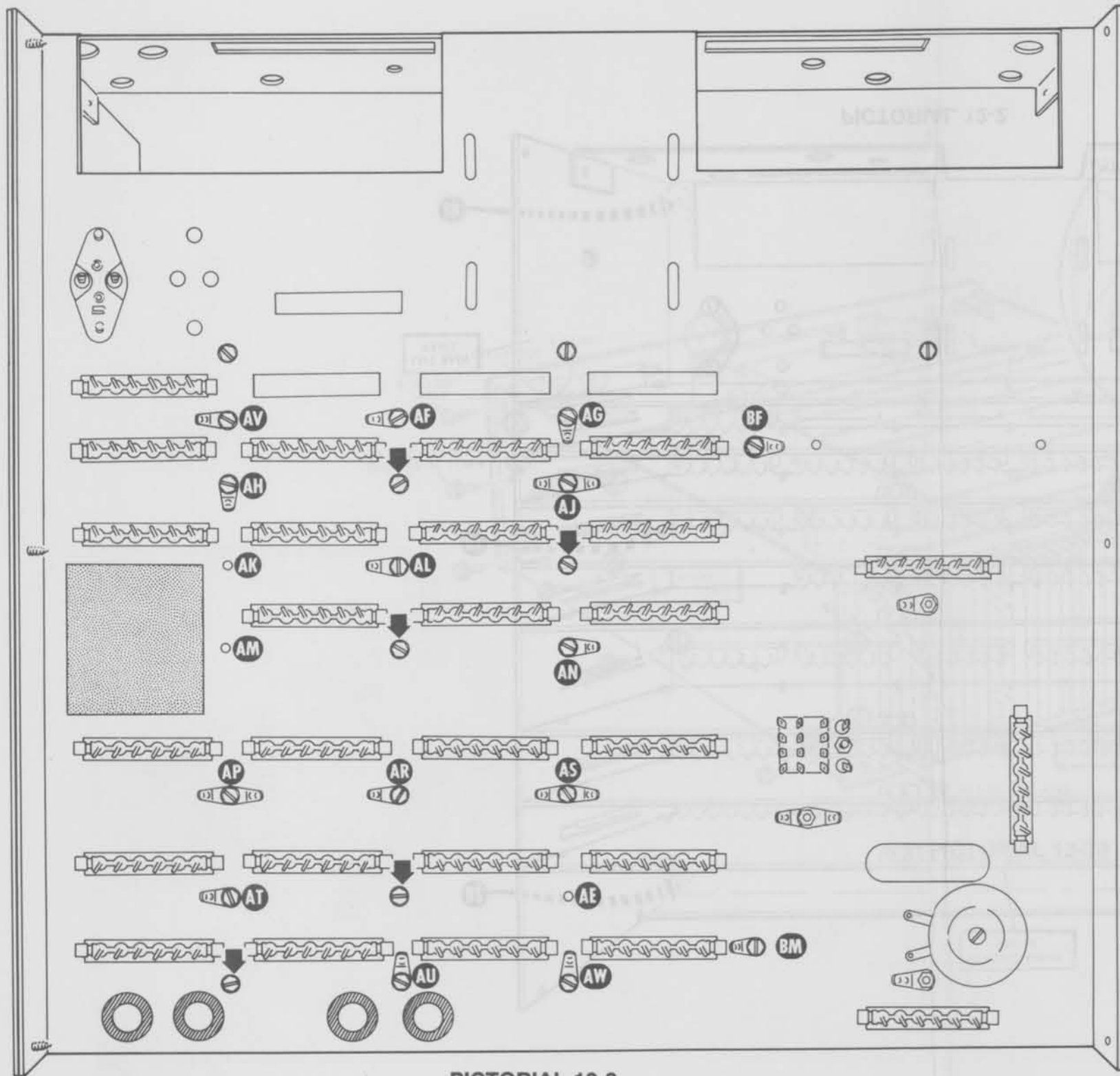

PICTORIAL 12-3

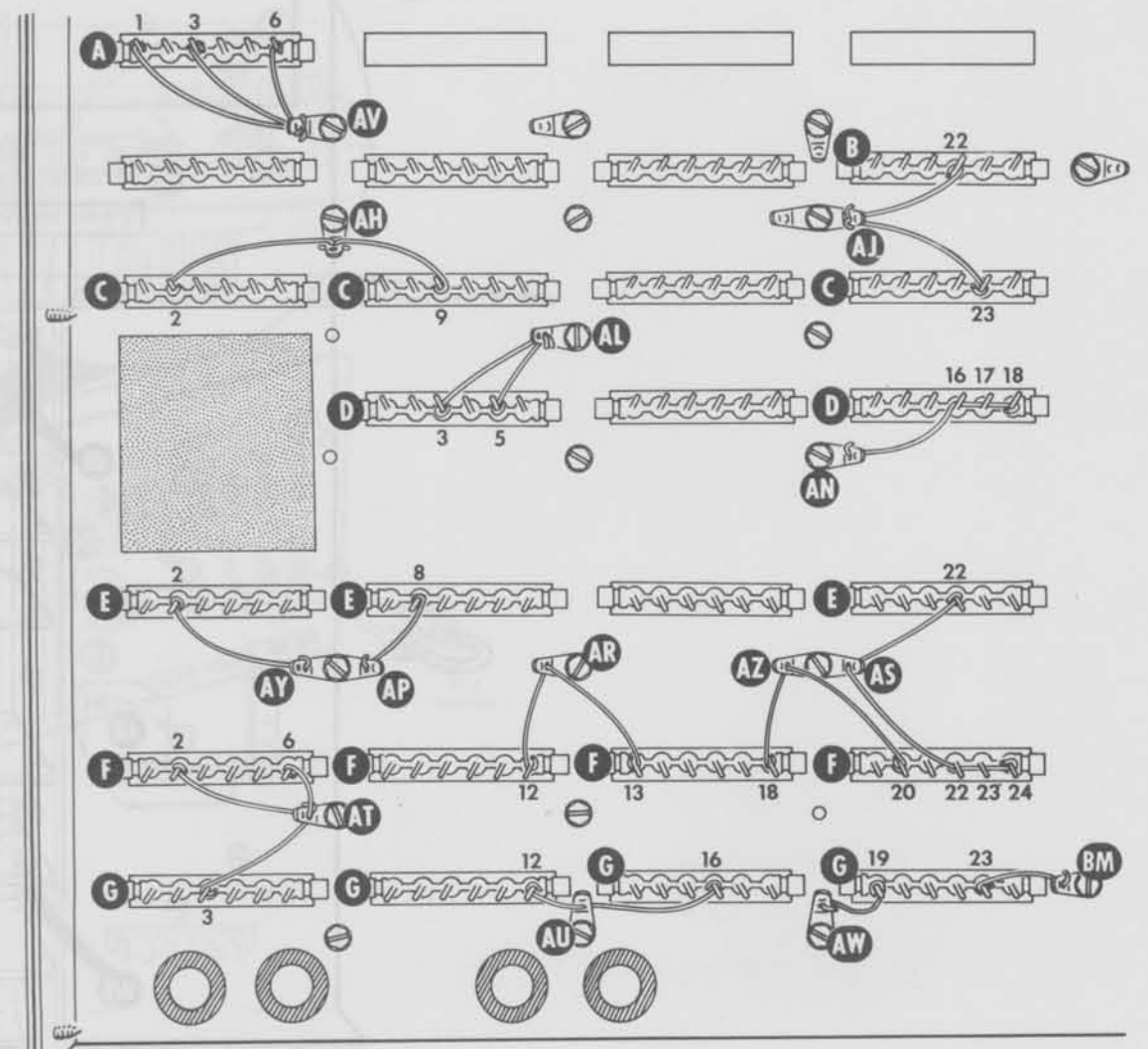

PICTORIAL 12-4

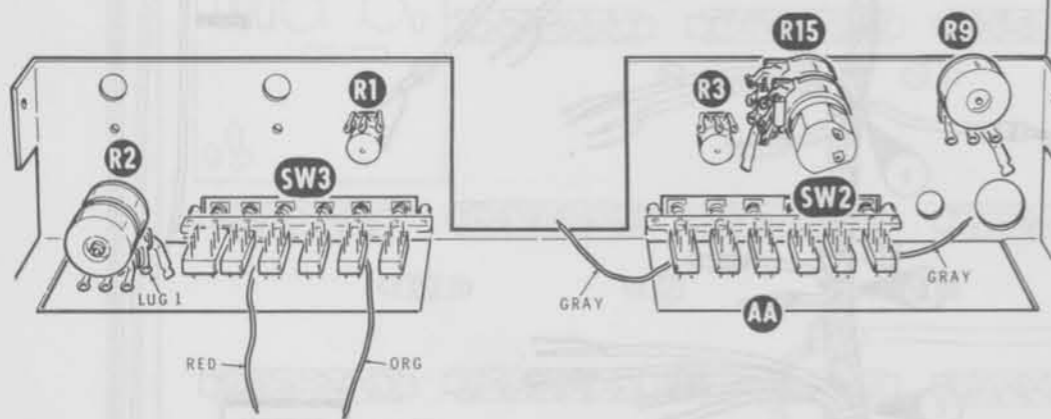

PICTORIAL 12-10

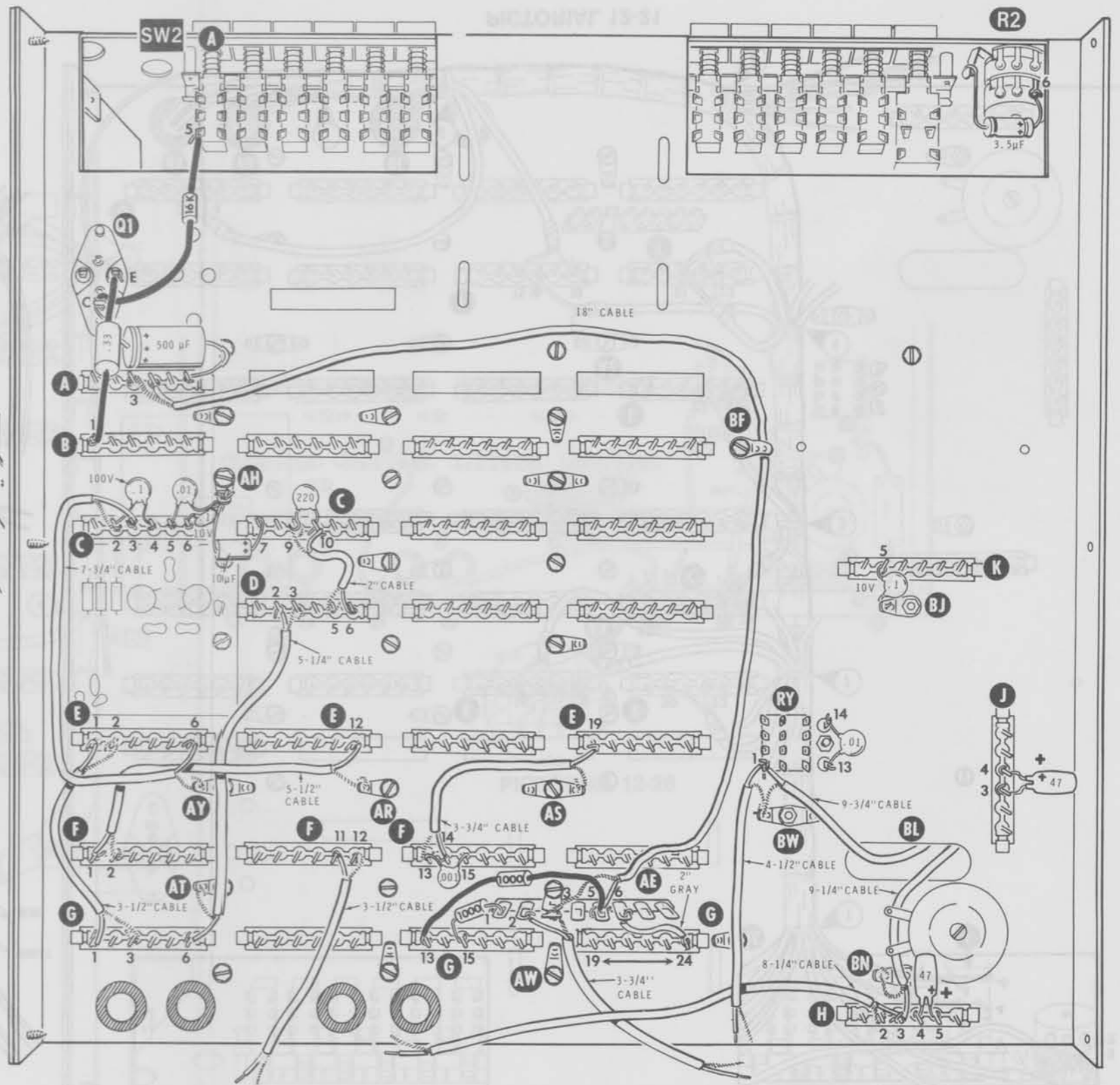

PICTORIAL 12-19

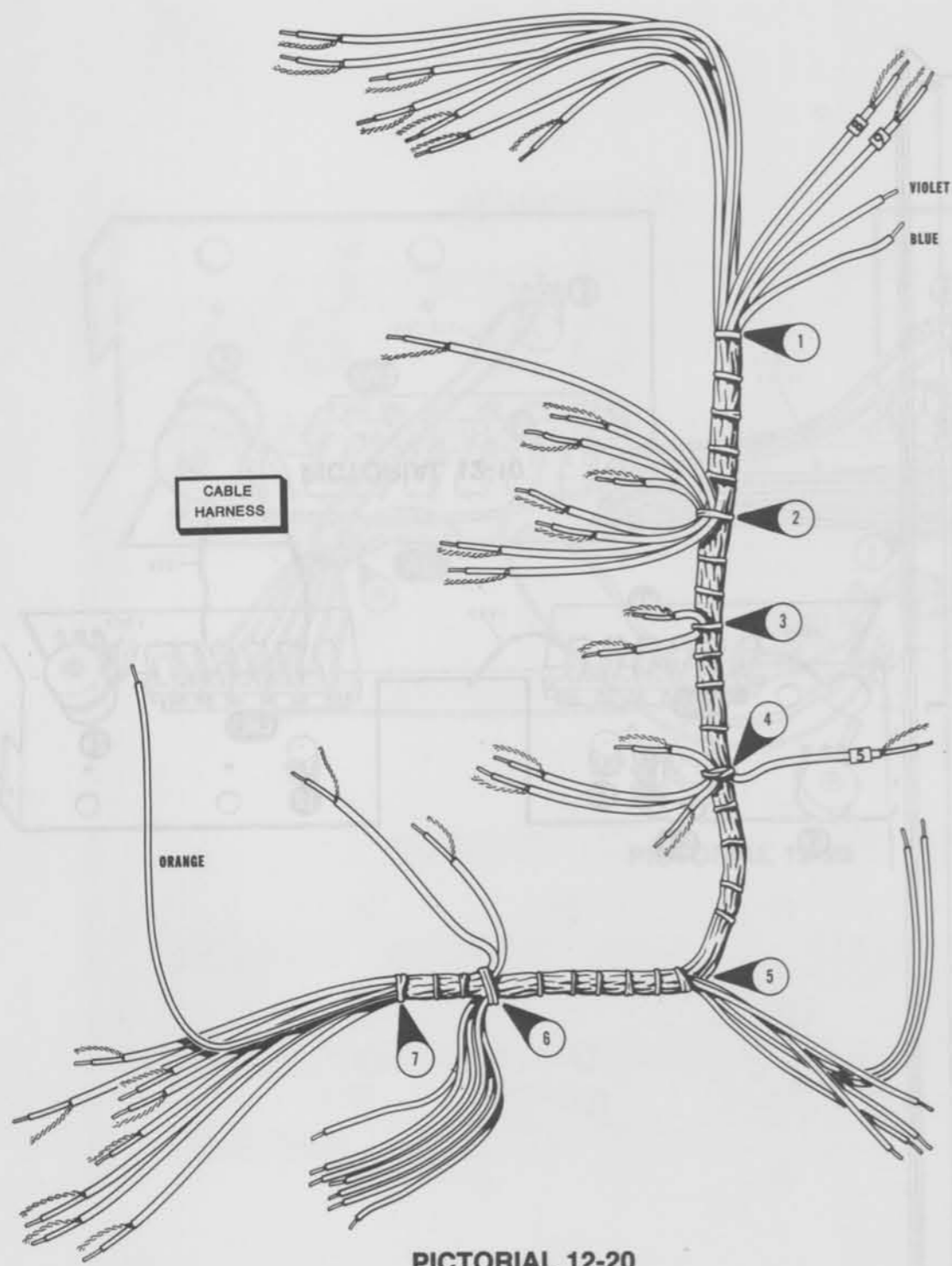

PICTORIAL 12-20

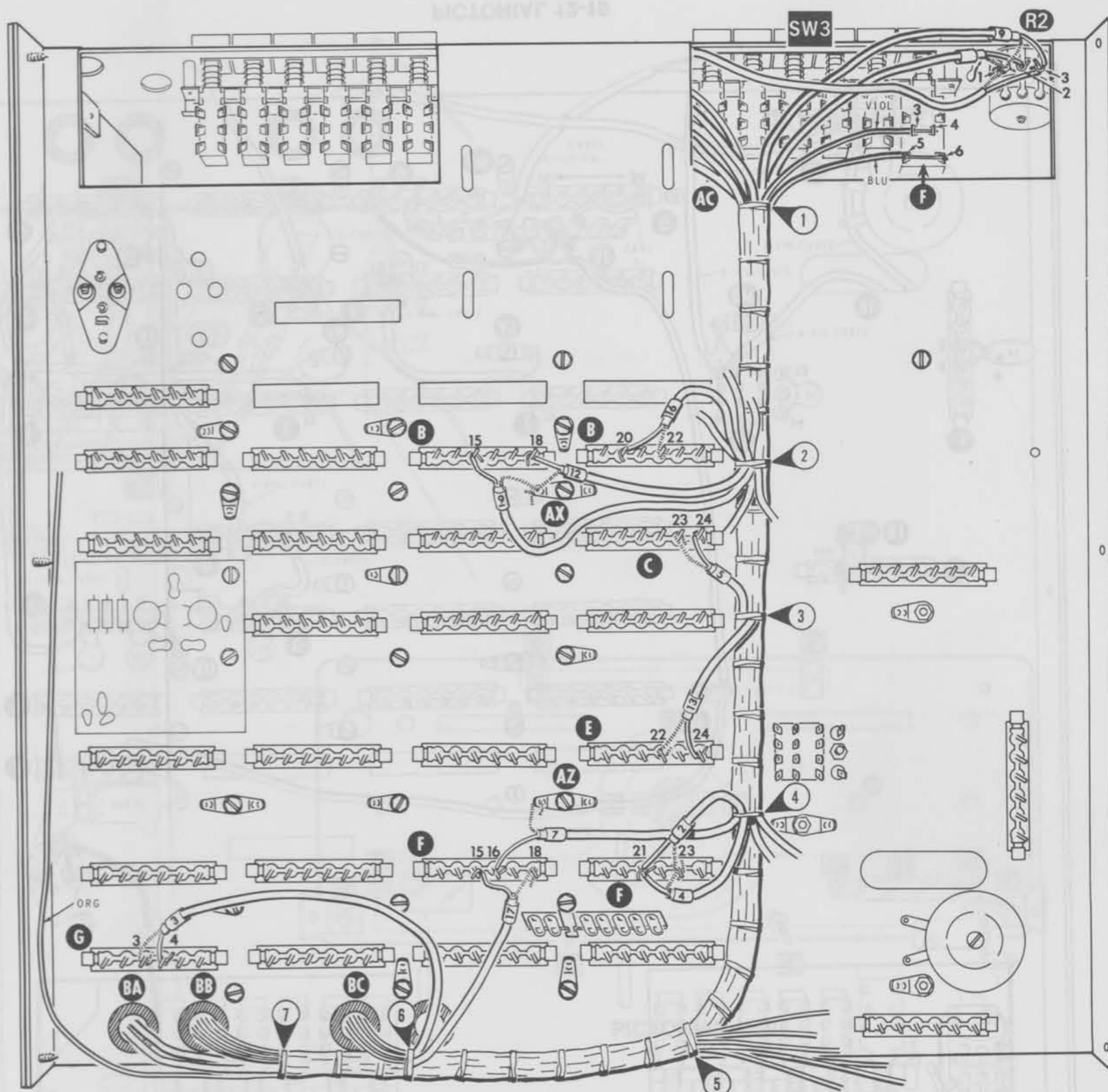

PICTORIAL 12-21

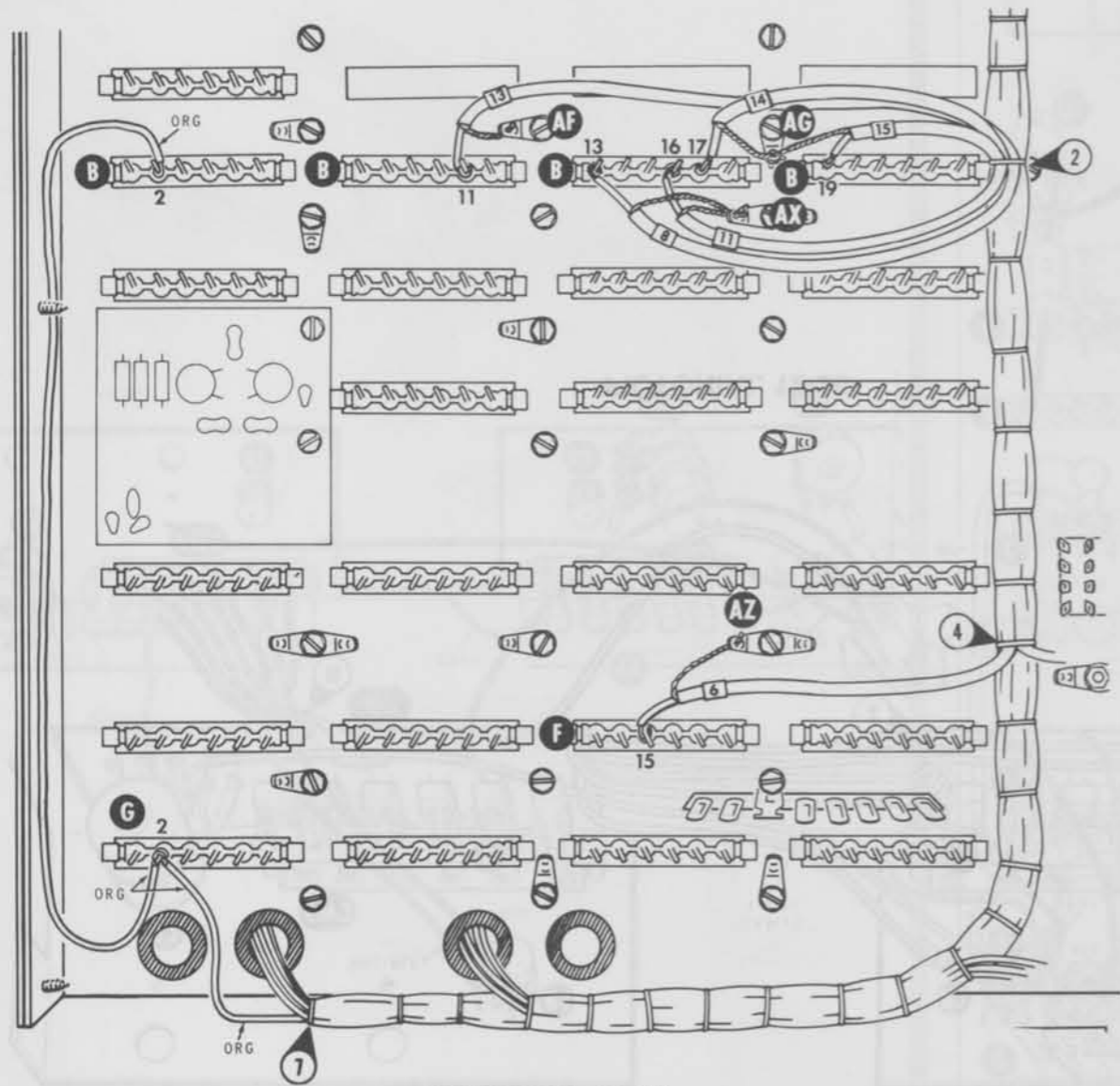

PICTORIAL 12-22

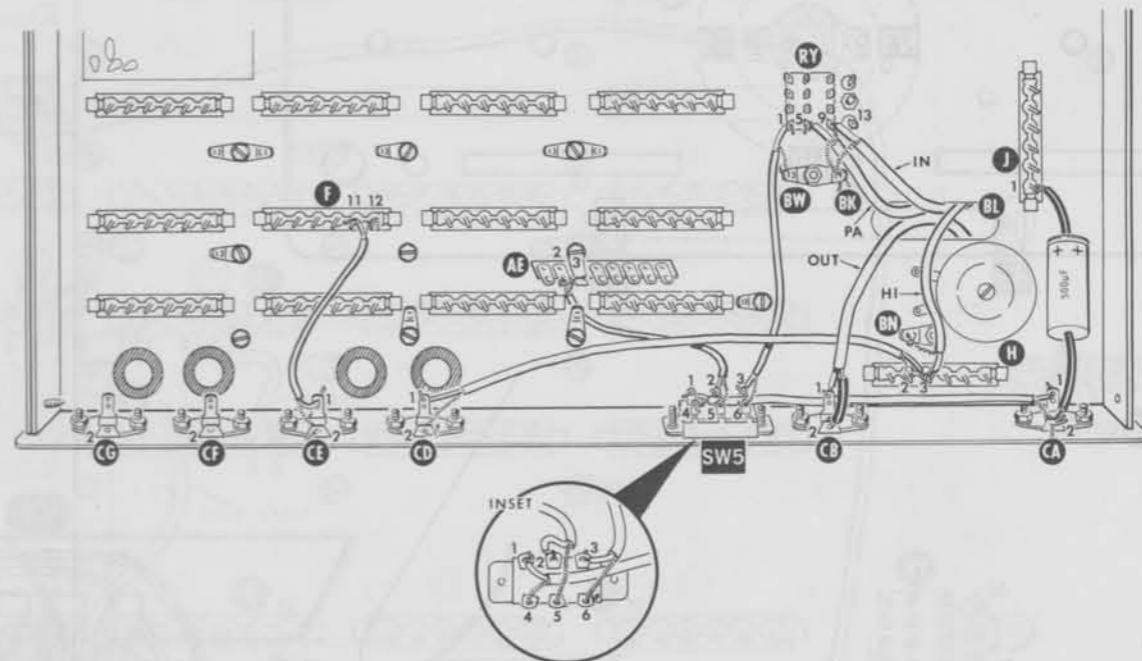

PICTORIAL 12-28

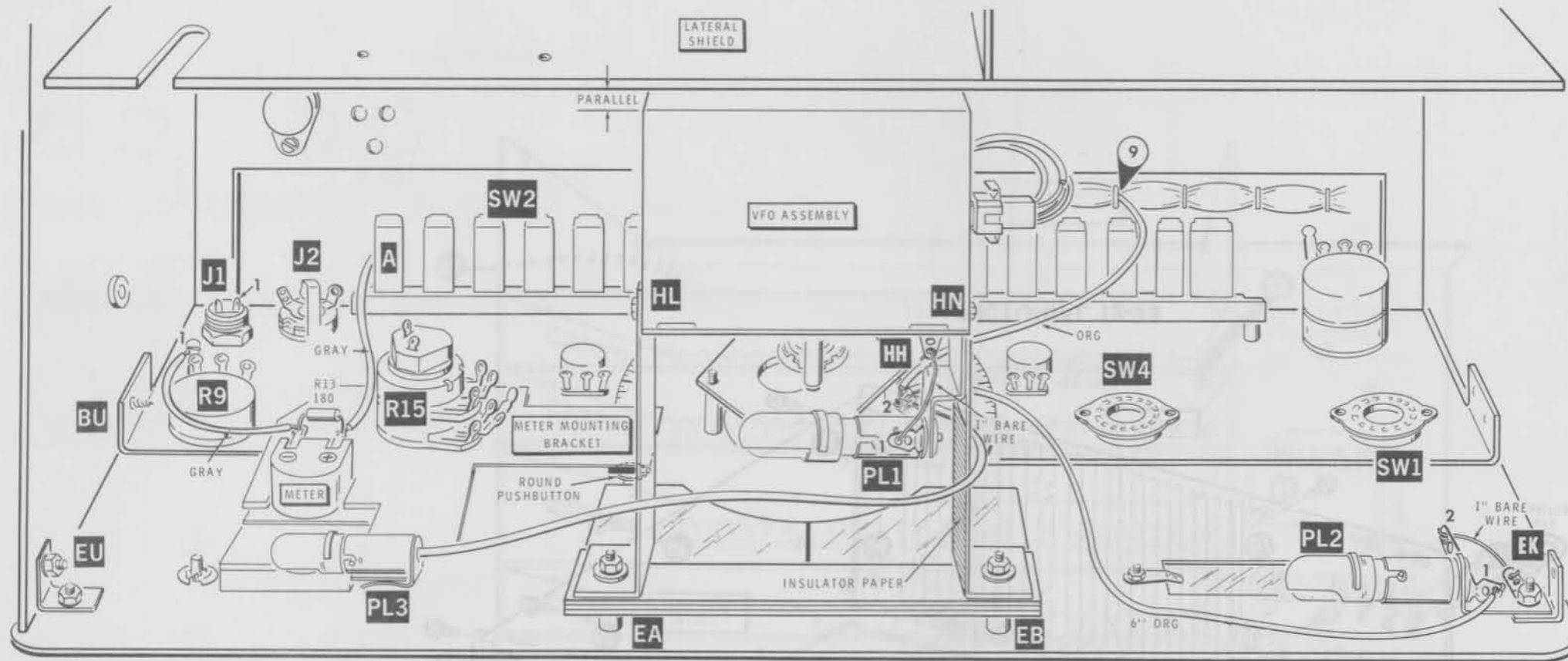

PICTORIAL 12-32

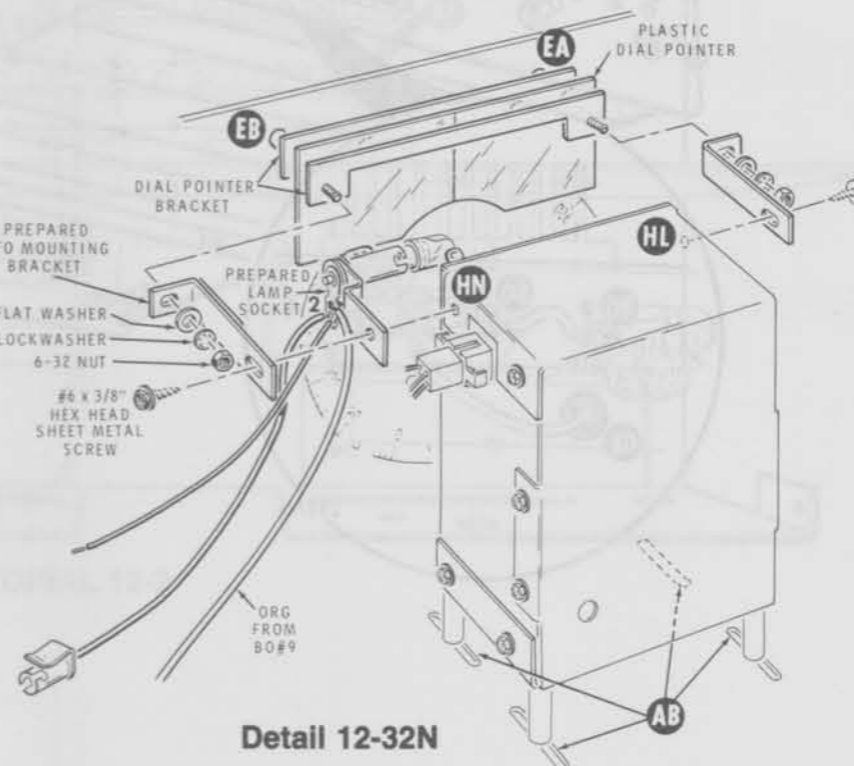

Detail 12-32N

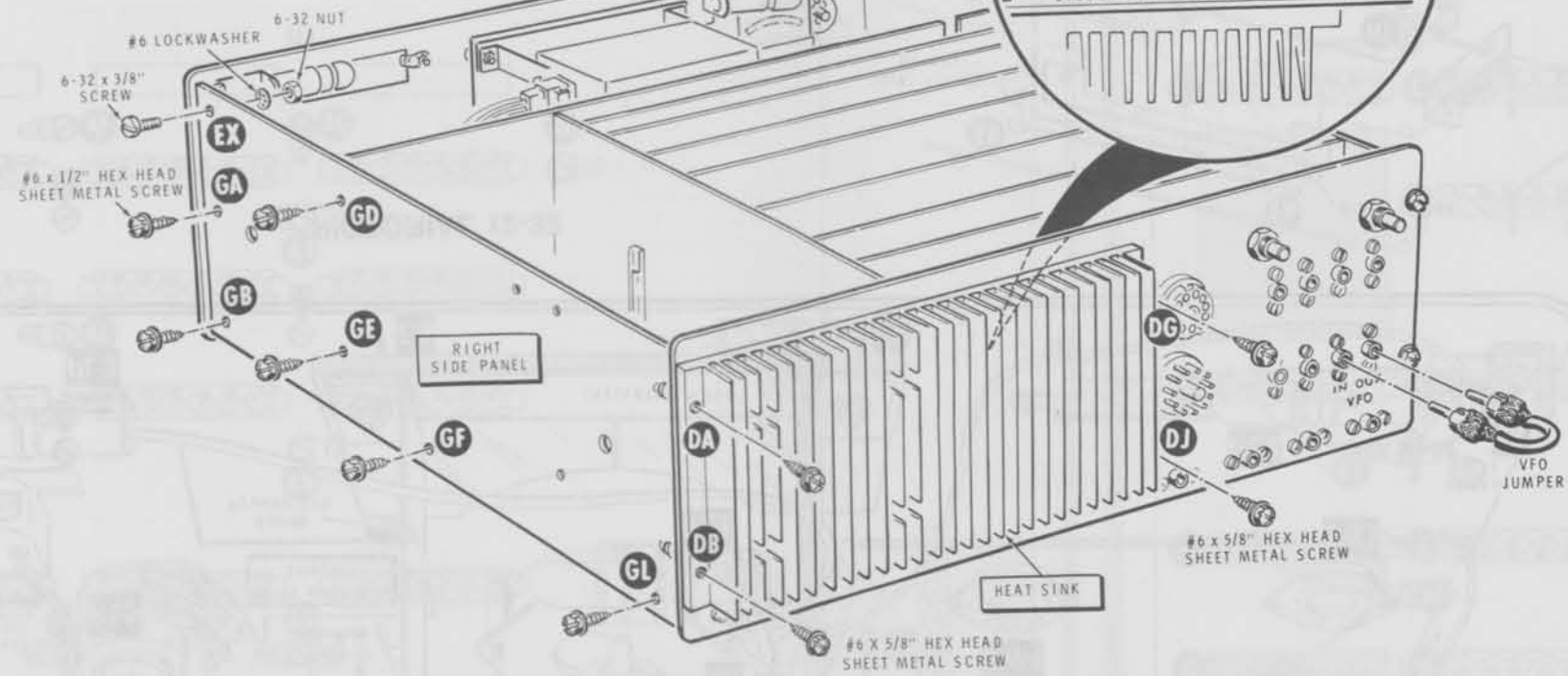

PICTORIAL 12-33