

HEATHKIT[®] MANUAL

for the
**PORTABLE
DIGITAL MULTIMETER**
Model IM-2215

595-2233

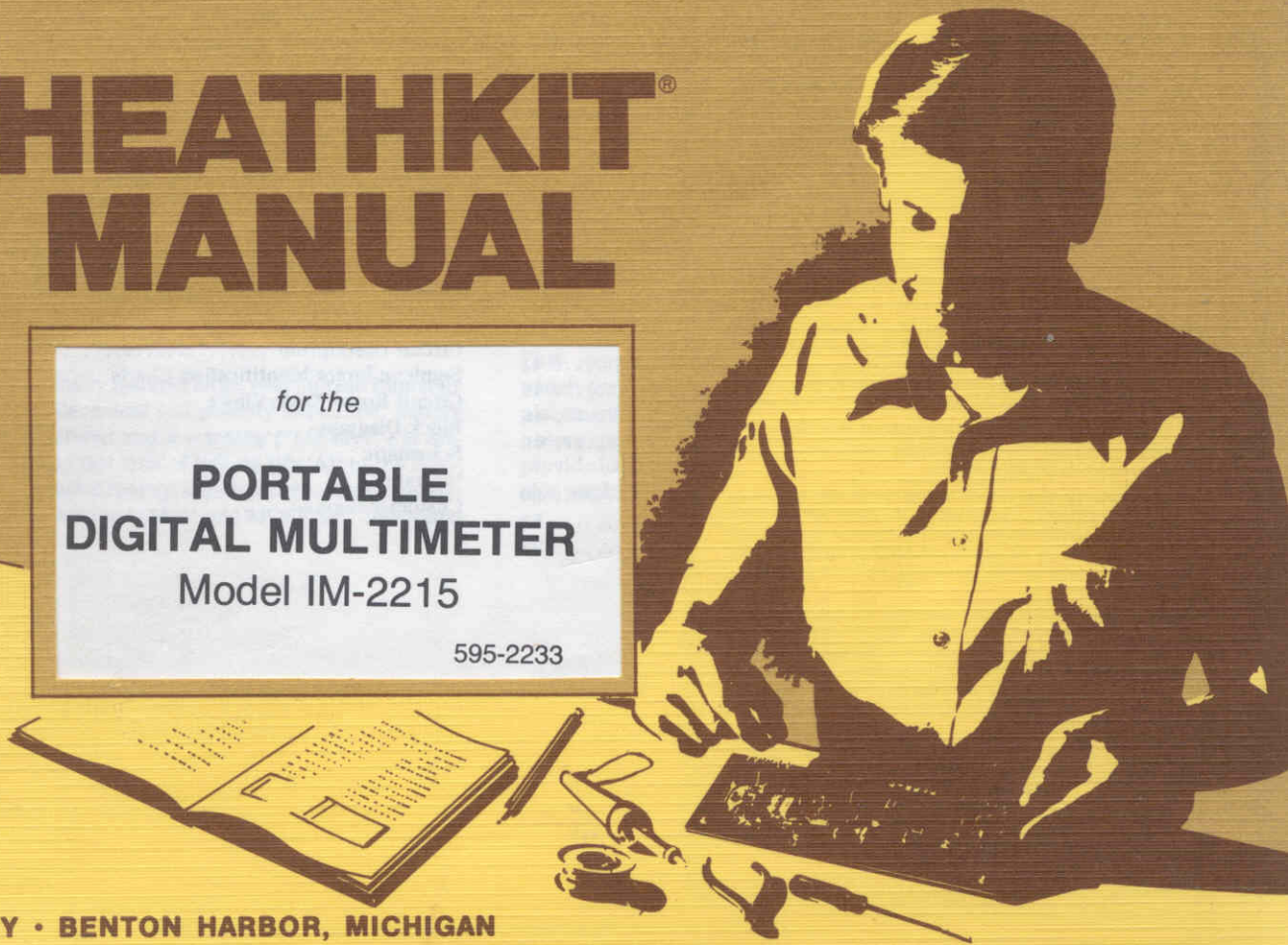

HEATH COMPANY PHONE DIRECTORY

The following telephone numbers are direct lines to the departments listed:

Kit orders and delivery information	(616) 982-3411
Credit	(616) 982-3561
Replacement Parts	(616) 982-3571

Technical Assistance Phone Numbers

8:00 A.M. to 4:30 P.M., EST, Weekdays Only

Audio	(616) 982-3310
Amateur Radio	(616) 982-3296
Test Equipment, Weather Instruments and Home Clocks	(616) 982-3315
Television	(616) 982-3307
Aircraft, Marine, Security, Scanners, Automotive, Appliances and General Products	(616) 982-3496
Computers — Hardware	(616) 982-3309
Computers — Software	(616) 982-3860
Operating Systems, Languages, Utilities	(616) 982-3860
Application Programs	(616) 982-3884

YOUR HEATHKIT 90-DAY LIMITED WARRANTY

Consumer Protection Plan for Heathkit Consumer Products

Welcome to the Heath family. We believe you will enjoy assembling your kit and will be pleased with its performance. Please read this Consumer Protection Plan carefully. It is a LIMITED WARRANTY, as defined in the U.S. Consumer Product Warranty and Federal Trade Commission Improvement Act. This warranty gives you specific legal rights, and you may also have other rights which vary from state to state.

Heath's Responsibility

PARTS — Replacements for factory defective parts will be supplied free for 90 days from date of purchase. Replacement parts are warranted for the remaining portion of the original warranty period. You can obtain warranty parts direct from Heath Company by writing or telephoning us at (616) 982-3571. And we will pay shipping charges to get those parts to you anywhere in the world.

SERVICE LABOR — For a period of 90 days from the date of purchase, any malfunction caused by defective parts or error in design will be corrected at no charge to you. You must deliver the unit at your expense to the Heath factory, any Heathkit Electronic Center (units of Venterchology Electronics Corporation), or any of our authorized overseas distributors.

TECHNICAL CONSULTATION — You will receive free consultation on any problem you might encounter in the assembly or use of your Heathkit product. Just drop us a line or give us a call. Sorry, we cannot accept collect calls.

NOT COVERED — The correction of assembly errors, adjustments, calibration, and damage due to misuse, abuse, or negligence are not covered by the warranty. Use of corrosive solder and/or the unauthorized modification of the product or of any furnished component will void this warranty in its entirety. This warranty does not include reimbursement for inconvenience, loss of use, customer assembly, set-up time, or unauthorized service.

This warranty covers only Heath products and is not extended to other equipment or components that a customer uses in conjunction with our products.

SUCH REPAIR AND REPLACEMENT SHALL BE THE SOLE REMEDY OF THE CUSTOMER AND THERE SHALL BE NO LIABILITY ON THE PART OF HEATH FOR ANY SPECIAL, INDIRECT, INCIDENTAL OR CONSEQUENTIAL DAMAGES, INCLUDING BUT NOT LIMITED TO ANY LOSS OF BUSINESS OR PROFITS, WHETHER OR NOT FORSEEABLE.

Some states do not allow the exclusion or limitation of incidental or consequential damages, so the above limitation or exclusion may not apply to you.

Owner's Responsibility

EFFECTIVE WARRANTY DATE — Warranty begins on the date of first consumer purchase. You must supply a copy of your proof of purchase when you request warranty service or parts.

ASSEMBLY — Before seeking warranty service, you should complete the assembly by carefully following the manual instructions. Heathkit service agencies cannot complete assembly and adjustments that are customer's responsibility.

ACCESSORY EQUIPMENT — Performance malfunctions involving other non-Heath accessory equipment, (antennas, audio components, computer peripherals and software, etc.) are not covered by this warranty and are the owner's responsibility.

SHIPPING UNITS — Follow the packing instructions published in the assembly manuals. Damage due to inadequate packing cannot be repaired under warranty.

If you are not satisfied with our service (warranty or otherwise) or our products, write directly to our Director of Customer Service, Heath Company, Benton Harbor MI 49022. He will make certain your problems receive immediate, personal attention.



Heathkit® Manual

for the

PORTABLE DIGITAL MULTIMETER

Model IM-2215

595-2233

HEATH COMPANY
BENTON HARBOR, MICHIGAN 49022

Copyright © 1979
Heath Company
All Rights Reserved
Printed in the United States of America

TABLE OF CONTENTS

Introduction	3	In Case of Difficulty	
Parts List	4	General Troubleshooting Information	63
Assembly Notes	11	Troubleshooting Precautions	64
Step-By-Step Assembly		Troubleshooting Charts	65
Main Circuit Board	14	Circuit Board Cleaning	70
Display Circuit Board	32	Specifications	70
General Assembly and Wiring	35	Circuit Description	76
Test Lead Preparation	42	Semiconductor Identification Charts	82
Operational Tests	44	Circuit Board X-RayViews	88
Calibration	46	Block Diagram	(Illustration Booklet, Page 19)
Final Assembly	49	Schematic	(fold-in)
Operation		Warranty	Inside front cover
General	50	Customer Service	Inside rear cover
Operating Characteristics	52		
Measurements	53		

INTRODUCTION

This Portable Digital Multimeter (DMM) is a compact, hand-held instrument designed for both field and laboratory use. Built-in references enable you to calibrate it to the accuracies listed in the Specifications section of this Manual. A 9-volt alkaline battery (not supplied) typically provides 200 hours of operation. You can also operate the Multimeter continuously from line voltage using one of the optional Heathkit converter/chargers* available for this kit.

The 3-1/2 digit, liquid crystal display features large, easy-to-read numerals with automatic decimal point placement and polarity indication. Battery condition is continuously monitored and a warning ("LO BAT") is displayed during approximately the last 20% of battery life. All of the dual-slope, analog-to-digital conversion circuitry, which provides extremely stable and accurate performance is contained in one MOS/LSI** integrated circuit.

Measurement functions include AC and DC voltages, AC and DC currents, and resistance. All functions are protected by fuse and diode against overload and transients. Voltage and current inputs are separated to protect the Multimeter and the circuitry being tested. The "full-scale" resistance test voltage alternates from high to low over the six ranges to allow both semiconductor testing and in-circuit resistance measurements.

This compact, lightweight instrument features push-button switching, which permits one-hand operation, leaving the other hand free for probe placement. A pivoting stand is used to support the front of the instrument at a more convenient viewing angle. This carefully designed Multimeter will provide long, reliable performance for your laboratory, workbench, or portable applications.

*Model PS-2350 for 120 VAC operation and Model PS-2450 for 220 VAC operation.

**Metal-oxide semiconductor/large scale integration.

PARTS LIST

Unpack the kit and check each part against the following list. The key numbers correspond to the numbers in the Parts Pictorial (Illustration Booklet, Pages 1 thru 4). Return any part that is packed in an individual envelope back to the envelope after you identify it. Keep these parts in the envelopes until they are called for in an assembly step. Do NOT throw away any packing material until you account for all the parts.

To order a replacement part, always include the Part Number. Use the Parts Order Form furnished with this kit. If a Parts Order Form is not available, refer to "Replacement Parts" inside the rear cover of this Manual. For prices, refer to the separate "Heath Parts Price List."

Each circuit part in this kit has its own component number (R2, C4, etc.). Use these numbers when you want to identify the same part in the various sections of the Manual. These numbers, which are especially useful if a part has to be replaced, appear:

- In the Parts List,
- At the beginning of each step where a component is installed,
- In some illustrations,
- In the Schematic,
- In the sections at the rear of the Manual.

KEY No.	HEATH Part No.	QTY.	DESCRIPTION	CIRCUIT Comp. No.
---------	----------------	------	-------------	-------------------

RESISTORS

NOTES:

These resistors may be packed in more than one envelope. Open all the resistor envelopes in this pack before you check the resistors against the following list.

All color-coded 1% resistors have five color bands (last band brown). This brown band is set apart from the other bands. The last band (brown) will not be called out. Note that .1% resistors have the value rather than the color bands marked on them.

All 5% and 10% resistors have four color bands (last band gold for 5% and silver for 10%). The last band (gold or silver) will not be called out.

1/4-Watt, 1%

NOTE: The following resistors have a temperature coefficient (TC) of 100 par per million per °C (100 PPM/°C) unless otherwise noted.

A1	6-1001-12	1	1000 Ω (brn-blk-blk-brn)	R11
A1	6-1601-12	1	1600 Ω (brn-blu-blk-brn)	R8
A1	6-3011-12	1	3010 Ω (org-blk-brn-brn)	R33

KEY No.	HEATH Part No.	QTY.	DESCRIPTION	CIRCUIT Comp. No.
---------	----------------	------	-------------	-------------------

1/4-Watt, 1% (cont'd.)

A1	6-4421-12	1	4420 Ω (yel-yel-red-brn)	R15
A1	6-6811-12	2	6810 Ω (blu-gry-brn-brn)	R29, R32
A1	6-1072-12	1	10.7 kΩ (brn-blk-viol-red)	R12
A1	6-4872-12	1	48.7 kΩ (yel-gry-viol-red)	R17
A1	6-1133-12	1	113 kΩ (brn-brn-org-org)	R38
A1	6-1503-12	1	150 kΩ (brn-grn-blk-org)	R27
A1	6-1004-12	1	1 MΩ, 150 PPM/°C (brn-blk-blk-yel)	R25

1/4-Watt, 5%

A2	6-470-12	1	47 Ω (yel-viol-blk)	R39
A2	6-271-12	1	270 Ω (red-viol-brn)	R6
A2	6-102-12	1	1000 Ω (brn-blk-red)	R9
A2	6-103-12	1	10 kΩ (brn-blk-org)	R14
A2	6-473-12	1	47 kΩ (yel-viol-org)	R37
A2	6-104-12	2	100 kΩ (brn-blk-yel)	R7, R28
A2	6-125-12	1	120 kΩ (brn-red-yel)	R36
A2	6-224-12	1	220 kΩ (red-red-yel)	R24
A2	6-474-12	4	470 kΩ (yel-viol-yel)	R18, R19, R21, R26

KEY No.	HEATH Part No.	QTY.	DESCRIPTION	CIRCUIT Comp. No.
---------	----------------	------	-------------	-------------------

1/4-Watt, 5% (cont'd.)

A2	6-105-12	1	1 MΩ (brn-blk-grn)	R31
----	----------	---	--------------------	-----

Other Resistors

A3	3-6-3	1	9 Ω, 3-watt, .1%, 50 PPM/°C	R3
A4	2-366	1	90 Ω, 1/2-watt, .1%, 25 PPM/°C	R2
A5	2-758-12	1	100 Ω, 1/4-watt, .1%, 50 PPM/°C	R5
A6	1-15-2	1	1000 Ω, 2-watt, 10% (brn-blk-red)	R1
A7	1-28-1	1	100 kΩ, 1-watt, 10% (brn-blk-yel)	R4
A7	1-34-1	1	1 MΩ, 1-watt, 10% (brn-blk-grn)	R35
A8	1-70	1	22 MΩ, 1/2-watt, 10% (red-red-blu)	R23
A8	1-141	1	1000 MΩ, 1/2-watt, 20% (brn-blk-gry)	R22

KEY No.	HEATH Part No.	QTY.	DESCRIPTION	CIRCUIT Comp. No.
---------	----------------	------	-------------	-------------------

RESISTOR NETWORKS — THERMISTOR

A9	9-89	1	.1 Ω /.9 Ω , .1% resistor network	RN2
A10	9-94	1	900 Ω -9M Ω , .1% resistor network	RN1
A11	9-95	1	1000 Ω , 40% thermistor	RT1

CAPACITORS**Mica**

B1	20-148	1	100 pF	C15
B1	20-128	1	470 pF	C3

Ceramic

B2	21-170	1	.75 pF spark gap	C1
B3	21-756	1	3.9 pF	C2
B3	21-171	1	680 pF	C11

Tantalum

B4	25-841	1	4.7 μ F (yel-viol-grn)	C4
B4	25-281	1	39 μ F	C8

KEY No.	HEATH Part No.	QTY.	DESCRIPTION	CIRCUIT Comp. No.
---------	----------------	------	-------------	-------------------

Capacitors (cont'd.)**Mylar***

B5	27-74	1	.01 μ F	C6
B6	27-204	1	.022 μ F	C5
B7	27-73	3	.047 μ F	C7, C9, C16
B6	27-194	3	.47 μ F	C12, C13, C14

DIODES

C1	56-56	6	1N4149	D3, D4, D7, D8, D9, D10
C1	56-90	1	1N4742A	ZD1
C1	56-652	2	1N4448	D5, D6
C1	57-613	2	1N5624, selected	D1, D2

*DuPont Registered Trademark.

KEY No.	HEATH Part No.	QTY.	DESCRIPTION	CIRCUIT Comp. No.
---------	----------------	------	-------------	-------------------

TRANSISTORS — INTEGRATED CIRCUITS (IC's)

NOTE: Transistors and integrated circuits are marked for identification in one of the following four ways:

1. Part number.
2. Type number. (On integrated circuits, use **only** those numbers and letters in **BOLD** print. Disregard any other numbers or letters.)
3. Part number and type number.
4. Part number with a type number other than the one shown.

C2	417-864	1	MPSA05 transistor	Q2
C2	417-875	4	2N3904 transistor	Q1, Q3, Q4, Q5
C3	442-679	1	TL061CP IC	U2

NOTE: The following IC's are packed in a special foam material to protect them from possible damage due to static electricity. Do not remove these IC's from their protective foam material until you are instructed to do so.

C4	442-678	1	ICL7106CPL IC	U4
C5	443-917	1	CD4030AE IC	U3

KEY No.	HEATH Part No.	QTY.	DESCRIPTION	CIRCUIT Comp. No.
---------	----------------	------	-------------	-------------------

CONTROLS — SWITCHES

D1	10-1140	1	500 Ω control	R34
D1	10-1141	1	1000 Ω , (1k) control	R13
D2	10-1132	1	10 k Ω control	R16
D3	60-632	1	Slide switch	SW9
D4	64-871	1	Pushbutton switch assembly	SW1-SW8

CONNECTORS — SOCKETS

IMPORTANT: Do NOT remove the LCD socket assembly parts from the envelope until you are instructed to do so in a step. Otherwise, you may contaminate these parts.

	100-1754	1	LCD socket assembly consisting of:	
E1		1	LCD holder	
E2		2	Elastomeric contact strip	
E3	259-20	2	Connector pin	

KEY No.	HEATH Part No.	QTY.	DESCRIPTION	CIRCUIT Comp. No.
E4	434-230	1	8-pin IC socket	
E5	434-253	1	40-pin IC socket	
E6	434-298	1	14-pin IC socket	

JACKS

F1	436-49	1	PCB jack	J4
F2	436-50	3	Banana jack	J1, J2, J3

OTHER CIRCUIT COMPONENTS

G1	134-1065	1	28-wire ribbon cable	
G2	266-1031	1	Battery connector/ fuseholder assembly	
G3	411-843	1	LCD (liquid crystal display)	
G4	421-45	1	2-ampere fuse	F1

KEY No.	HEATH Part No.	QTY.	DESCRIPTION	CIRCUIT Comp. No.
---------	----------------	------	-------------	-------------------

HARDWARE

#4 and #5 Hardware

H1	250-4	2	4-40 × 3/8" screw	
H2	250-186	4	#4 × 3/8" self-tapping screw	
H3	252-2	2	4-40 nut	
H4	253-43	4	#5 fiber flat washer	
H5	254-9	2	#4 lockwasher	

#6 Hardware

H6	250-587	5	6-32 × 5/16" screw	
H7	250-1300	3	#6 × 5/8" self-tapping screw	
H8	253-60	1	#6 flat washer	
H9	254-25	7	#6 lockwasher	
H10	255-71	1	6-32 × 3/4" spacer	

KEY No.	HEATH Part No.	QTY.	DESCRIPTION	CIRCUIT Comp. No.
---------	----------------	------	-------------	-------------------

WINDOW — CASE PARTS

J1	446-706	1	Display window	
	305-76	1	Case parts consisting of:	
J2	92-696	1	Case bottom	
J3	92-697	1	Case top	
J4	92-698	1	Switch cover plate	
J5	92-699	2	Display bracket	
J6	210-117	1	Bezel	
J7	462-1075	8	Knob	

SHIELDED CABLE — WIRE

343-15	9"	Shielded cable
344-56	6"	Blue wire

KEY No.	HEATH Part No.	QTY.	DESCRIPTION	CIRCUIT Comp. No.
---------	----------------	------	-------------	-------------------

TEST LEAD PARTS

K1	70-10	1	Black plug insulator
K1	70-11	1	Red plug insulator
K2	73-21	1	Alligator clip insulator
K3	260-1	1	Alligator clip
	341-1	36"	Black test lead
	341-2	36"	Red test lead
K4	438-47	2	Banana plug
K5	439-7	1	Test probe
K6	439-9	1	Test probe collar

MISCELLANEOUS

L1	73-142	2	Rubber gasket
L2	75-782	1	PCB jack insulator
	75-738	1	Insulating paper

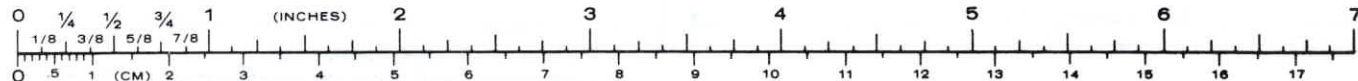



KEY No.	HEATH Part No.	QTY.	DESCRIPTION	CIRCUIT Comp. No.
---------	----------------	------	-------------	-------------------

Miscellaneous (cont'd.)

IMPORTANT: Refer to the "Important Construction Procedure" on Page 13 before you handle the main circuit board.

85-2176	1	Display circuit board
85-2196-2	1	Main circuit board
100-1757	1	DC calibration package consisting of:

L3	1	Selected ICL 8069DCQ or U1 MPS-5010
----	---	--

L4	266-1030	1	Bail
	490-185	1	Package of de-soldering braid Solder

PRINTED MATERIAL

M1	206-1312	1	Shield
M2	390-1520	1	Function/Range label
M3	390-1528	1	Caution label
M4	390-1529	1	DC calibration label
M5	390-1537	1	AC reference label

KEY No.	HEATH Part No.	QTY.	DESCRIPTION	CIRCUIT Comp. No.
---------	----------------	------	-------------	-------------------

Printed Material (cont'd.)

M6	391-34	1	Blue and white label
	597-260	1	Parts order form
	597-308	1	Kit Builder's Guide
		1	Assembly Manual (See Page 1 for part number.)

BATTERY

You should purchase the following battery at this time for use in your kit:

One 9-volt transistor battery, NEDA #1604.

Representative manufacturers and their type numbers are:

Eveready #216, P3
 Burgess #2V6
 Mallory #TR-146X (long life)
 RCA #VS323
 Hellekens #410
 Varta #438
 CEI #6F22
 Ray-O-Vac #D1604-1 (long life)

ASSEMBLY NOTES

IMPORTANT: Before you start to assemble your Multimeter, it is very important that you read the following information on step-by-step assembly procedures, wiring, and soldering. Also read the information in the "Kit Builder's Guide."

Assembly

1. Follow the instructions carefully and read the entire step before you perform the operation.
2. The illustrations in this Manual are called Pictorials and Details. Pictorials show the overall operation for a group of assembly steps; Details generally illustrate a single step. When you are directed to refer to a certain Pictorial "for the following step," continue using that Pictorial until you are referred to another Pictorial for another group of steps.
3. This kit uses a separate "Illustration Booklet" that contains illustrations (Pictorials, Details, etc.) in addition to those included in the Assembly Manual. Keep the "Illustration Booklet" with the Assembly Manual. The illustrations in it are arranged in Pictorial number sequence.

Soldering

1. Due to the small area around some circuit board holes and the small areas between some foils, use care to prevent solder bridges between adjacent foil areas. Use only a **minimum amount of solder** and do not heat components excessively with the soldering iron. **Use no larger than a 40-watt soldering iron with a 1/8" to 3/16" pyramid or chisel tip.** Allow it to reach operating temperature; then apply it only long enough to make a good solder connection. If you think a solder bridge may exist, compare the foil on the circuit board with the "Circuit Board X-Ray Views" in the rear of this Manual.
2. Remember to keep the soldering iron tip clean. Wipe it often on a damp sponge or cloth; then apply solder to the tip to give the entire tip a wet look.

3. The circuit boards in this kit have foil on both sides. Note that the "component" (or lettered) side of the main circuit board has the outline of each component screened on it. All components will be mounted on this side of the circuit board and soldered to the **other** side. Do **NOT** solder on the component side of the circuit board unless you are instructed to do so.
4. The assembly of the main circuit board is divided into two sections. Refer to Pictorial 1-1 (Illustration Booklet, Page 5). Except for the pushbutton switch assembly and the three integrated circuits, all components will be installed in one section before you proceed to the other section.
5. Due to the nature of the foil pattern on the main circuit board, solder may be drawn through a circuit board hole from the foil side to the lettered side. **This is normal**, as many of the holes are "plated through" to connect the foils on both sides of the circuit board together. However, do not allow solder to flow into adjacent unused holes when you solder components to the foil.

Parts

1. Resistors will be called out by their resistance value (in Ω , $k\Omega$, or $M\Omega$) and color code.
2. Capacitors will be called out by their capacitance value (in pF or μF) and type (mica, ceramic, tantalum, or Mylar).

Important Construction Procedure

You must follow the procedure listed below whenever you handle the main circuit board in this kit. If you do not follow this procedure, the high impedance areas of the circuit board may be contaminated by salt and oil from your skin. When these areas become contaminated, your completed Multimeter may not meet the listed specifications when you operate it in certain environments (high humidity conditions, etc).

1. Wash your hands with soap and water before you handle the main circuit board. Handle the circuit board only by its edges.
2. Avoid any excessive accumulation of rosin build-up whenever you solder a connection.

NOTE: The "Operational Tests" and "In Case of Difficulty" sections of this Manual will allow you to determine if the main circuit board has been contaminated. If necessary, you will be referred to a circuit board cleaning procedure.

Construction Hints

The following valuable hints will help you do a good assembly job.

- A. Take your time when you assemble the circuit boards. Work at a slow pace. Remember that accuracy is far more important than speed. Work with a good light to help reduce eye strain.
- B. When you perform the steps in the circuit board Pictorials, identify each component **before** you install it. Then position it over its outline on the circuit board as shown in the Detail drawing.
- C. If you find it necessary to remove a component from the circuit board, use the desoldering braid supplied with this kit. Follow the directions on the package.

Main Circuit Board

STEP-BY-STEP ASSEMBLY

START

Make sure you have read the "Important Construction Procedure" on Page 13 before you start to assemble the main circuit board.

IMPORTANT: The following steps give detailed information on how to install and solder the first part on the main circuit board. The remaining parts will be installed in a similar manner.

() Position the main circuit board as shown in Pictorial 1-2 with the lettered side up.

NOTE: On the following Pictorials, you will install components in section A of the circuit board. See Pictorial 1-1 (Illustration Booklet, Page 5).

() Hold a 120 k Ω (brn-red-yel) resistor and bend both leads straight down as shown.

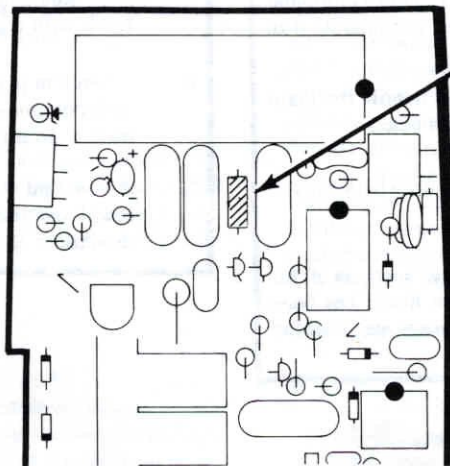

PICTORIAL 1-2

CONTINUE

() R36: Mount the 120 k Ω resistor horizontally on the circuit board as shown. Bend both leads outward to hold the resistor in place. Be sure to use the correct holes.

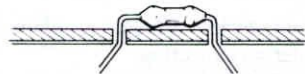

START ◀

- () Turn the circuit board over as shown in Pictorial 1-3 and solder the resistor leads to the circuit board as follows:

1. Push the soldering iron tip against both the lead and the circuit board foil. Heat both for 2 or 3 seconds.

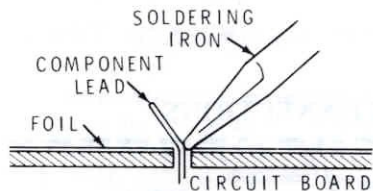

2. Then apply solder to the other side of the connection. **IMPORTANT:** Let the heated lead and the circuit board foil melt the solder.

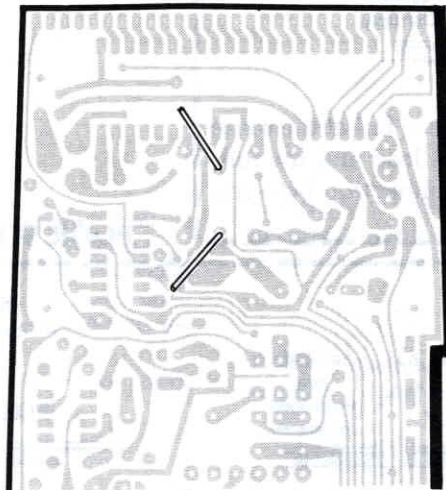
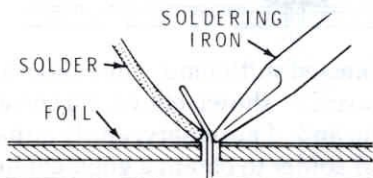

PICTORIAL 1-3

CONTINUE ▶

3. As the solder begins to melt, allow it to flow around the connection. Then remove the solder and iron and let the connection cool.

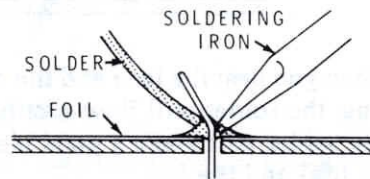

- () Hold each lead with one hand while you cut off the excess lead length close to the connection. This will keep you from being hit in the eye by a flying lead.
- () Check each connection. Compare it to the illustrations on the next two pages. After you have checked the solder connections, proceed with the assembly on Page 18. Use the same soldering procedure for each connection.

A GOOD SOLDER CONNECTION

Solder Flows Outward
And Gradually Blends
With The Foil And The
Lead.

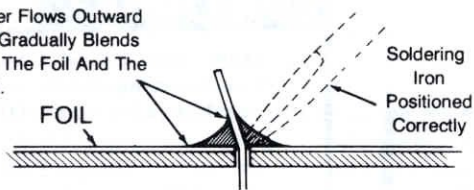

When you heat the lead and the circuit board foil at the same time, the solder will flow evenly onto the lead and the foil. The solder will make a good electrical connection between the lead and the foil.

POOR SOLDER CONNECTIONS

Solder Does Not Flow
Onto Lead. A Hard Rosin
Bead Surrounds And
Insulates Connection.



When the lead is not heated sufficiently, the solder will not flow onto the lead as shown above. To correct, reheat the connection and, if necessary, apply a small amount of additional solder to obtain a good connection.

Solder Appears To
Flow Inward And Sit On
Top Of Foil.

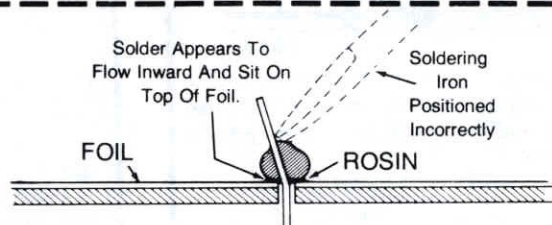

When the foil is not heated sufficiently the solder will blob on the circuit board as shown above. To correct, reheat the connection and, if necessary, apply a small amount of additional solder to obtain a good connection.

SOLDER BRIDGES

A solder bridge between two adjacent foils is shown in photograph A. Photograph B shows how the connection should appear. A solder bridge may occur if you accidentally touch an adjacent previously soldered connection, if you use too much solder, or if you "drag" the soldering iron across other foils as you remove it from the connection. A good rule to follow is: always take a good look at the foil area around each lead before you solder it. Then, when you solder the connection, make sure the solder remains in this area and does not bridge to another foil. This is especially important when the foils are small and close together. NOTE: It is alright for solder to bridge two connections on the same foil.

Use only enough solder to make a good connection, and lift the soldering iron straight up from the circuit board. If a solder bridge should develop, turn the circuit board foil-side-down and heat the solder between connections. The excess solder will run onto the tip of the soldering iron, and this will remove the solder bridge. NOTE: The foil side of most circuit boards has a coating on it called "solder resist." This is a protective insulation to help prevent solder bridges.

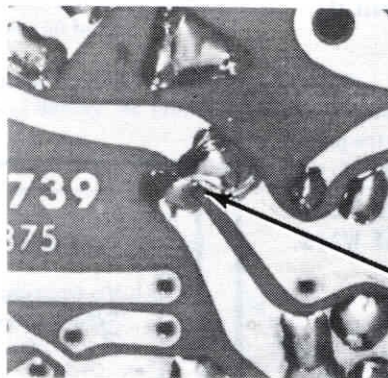
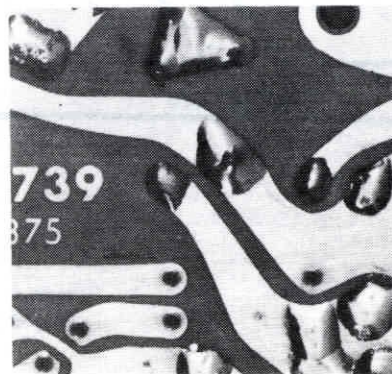
**A****SOLDER
BRIDGE****B**

Main Circuit Board (Cont'd)

START 

NOTE: Make sure you have installed the part in Pictorial 1-2.

IMPORTANT: THE BANDED END OF DIODES CAN BE MARKED IN A NUMBER OF WAYS.

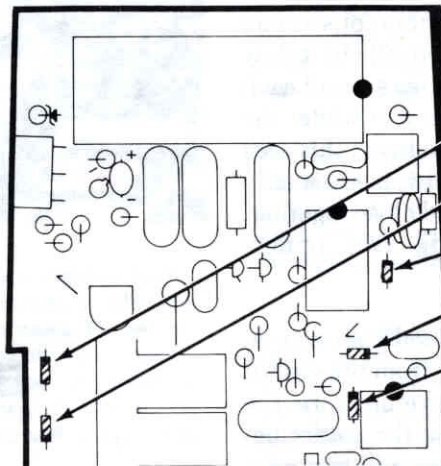
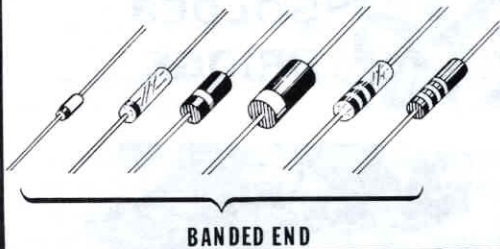
**CONTINUE** 

NOTE: When you install diodes, as in the following steps, be sure you position the banded end of each diode as it is shown on the circuit board.

- () D7: 1N4149 diode (#56-56).
- () D4: 1N4149 diode (#56-56).
- () D10: 1N4149 diode (#56-56).
- () D5: 1N4448 diode (#56-652).
- () D6: 1N4448 diode (#56-652).
- () Solder the leads to the foil and cut off the excess lead lengths.

PICTORIAL 1-4

START ↘

You will install IC sockets in the following steps. Be sure the socket pins are straight. Insert the pins in their respective holes, turn the circuit board over, and solder the pins to the foil. **Be sure the socket is down against the circuit board and all the pins protrude through the board.**

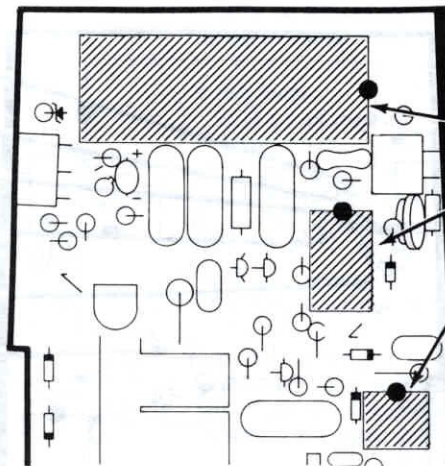
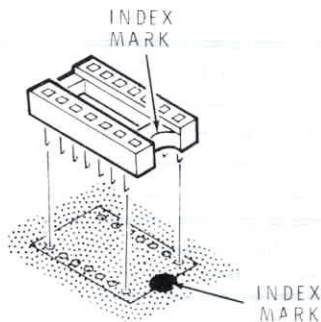
**CONTINUE** ↘

- () 40-pin IC socket.
- () 14-pin IC socket.
- () 8-pin IC socket.
- () Cut off any excess pin lengths.

PICTORIAL 1-5

START 

NOTE: Mount resistors vertically to the circuit board as shown unless a step directs you otherwise. Be sure each resistor is still vertical to the circuit board after you solder the leads to the foil.

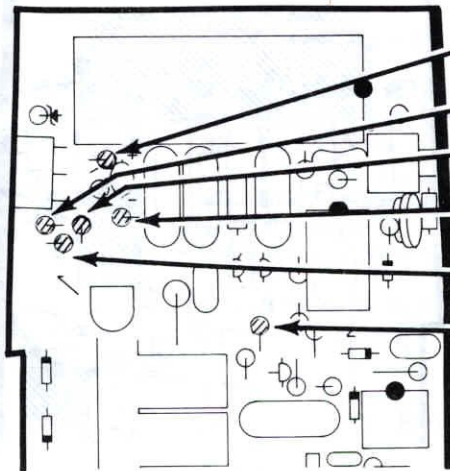
**CONTINUE** 

- () R8: 1600 Ω , 1% (brn-blu-blk-brn).
- () R11: 1000 Ω , 1% (brn-blk-blk-brn).
- () R9: 1000 Ω , (brn-blk-red).
- () R37: 47 k Ω , (yel-viol-org).
- () R12: 10.7 k Ω , 1% (brn-blk-viol-red).
- () R25: 1 M Ω , 1% (brn-blk-blk-yel).
- () Solder the leads to the foil and cut off the excess lead lengths.

PICTORIAL 1-6

START ▾

- () R39: 47 Ω (yel-viol-blk).
- () R24: 220 k Ω , (red-red-yel).
- () R38: 113 k Ω , 1% (brn-brn-org-org).
- () R17: 48.7 k Ω , 1% (yel-gry-viol-red).
- () R18: 470 k Ω (yel-viol-yel).
- () R21: 470 k Ω (yel-viol-yel).
- () R27: 150 k Ω , 1% (brn-grn-blk-org).
- () Solder the leads to the foil and cut off the excess lead lengths.

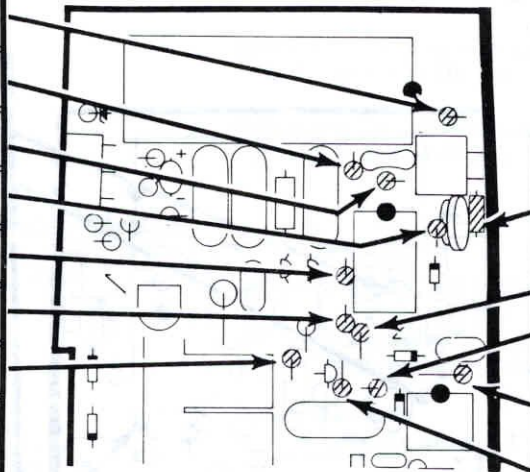
**CONTINUE** ▾

- () R15: 4420 Ω (4.42 k), 1% (yel-yel-red-brn).
Mount this resistor horizontally.
- () R19: 470 k Ω (yel-viol-yel).
- () R14: 10 k Ω (brn-blk-org).
- () R23: 22 M Ω , 1/2-watt (red-red-blu).
- () R26: 470 k Ω (yel-viol-yel).
- () Solder the leads to the foil and cut off the excess lead lengths.

PICTORIAL 1-7

START 

- () Locate the envelope labeled #100-1757 and remove the IC from it. Then transfer the calibration voltage written on the envelope to the DC calibration label (#390-1529). Save the label for use later.

NOTE: When you install the selected IC, line up the tab on the IC with the outline of the tab on the circuit board. Then insert the leads into the correct holes. Space the IC approximately 1/8" from the circuit board, as shown. Solder the leads to the foil and cut off the excess lead lengths.

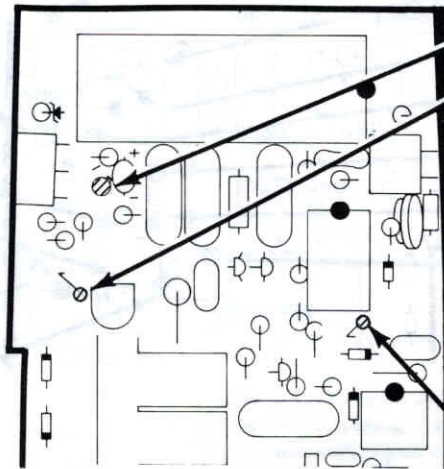
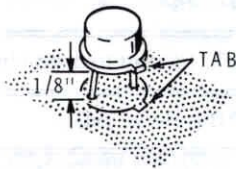
**CONTINUE** 

- () U1: Selected ICL8069 IC.
- () Wire connector at TP1. Solder it to the foil. NOTE: If the connector has a small tab on top, cut it off as shown.

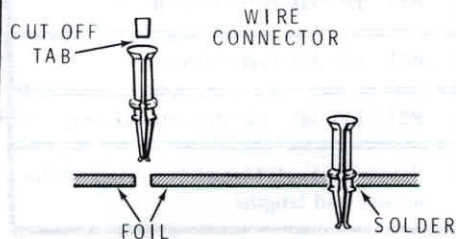

- () Wire connector at TP2. Solder it to the foil.

PICTORIAL 1-8

START ↓

NOTE: Install the following diode with the banded end down over the circle outline on the circuit board.

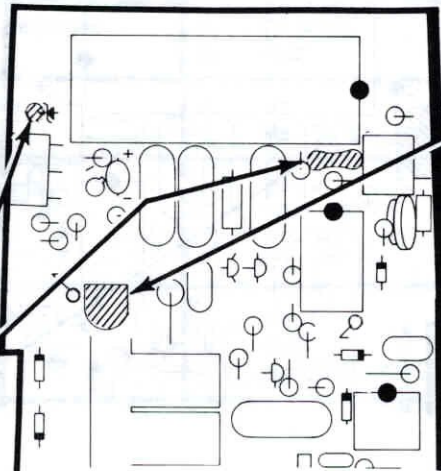

- () ZD1: 1N4742A zener diode (#56-90).
- () C15: 100 pF mica.
- () Solder the leads to the foil and cut off the excess lead lengths.

**CONTINUE** ↓

- () R13: 1000 Ω (1 k) control (#10-1141). Match the leads on the control with the holes on the circuit board. Then push the control down against the circuit board and solder the leads to the foil. Cut off the excess lead lengths.



PICTORIAL 1-9

START 

- () SW9: Slide switch. Push the switch firmly down so it is properly seated against the circuit board. Make sure the two tabs are seated properly in the cut-outs against the side of the circuit board. Then solder three lugs and both tabs to the foil.

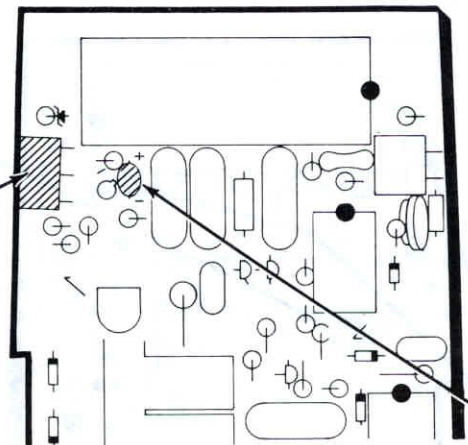
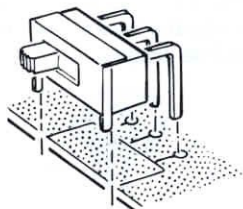
**CONTINUE** 

NOTE: When you install a tantalum capacitor, always match the plus (+) or dot marked side of the capacitor with the plus (+) mark on the circuit board.

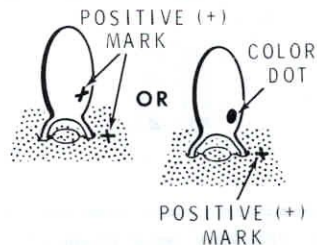

- () C4: 4.7 μ F (yel-viol-grn) tantalum.
- () Solder the leads to the foil and cut off the excess lengths.

PICTORIAL 1-10

START ▾

- () J4: PCB jack. Push the jack firmly down so it is properly seated against the circuit board. Then solder the lugs to the foil and cut off any excess lug lengths.

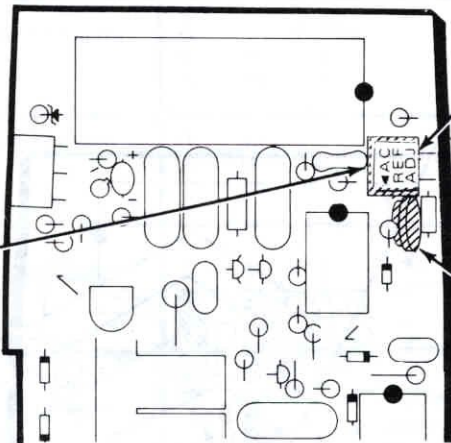
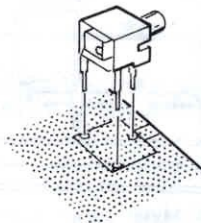
**CONTINUE** ▾

- () Peel away the paper backing from the AC reference label. Then press the label in place on top of the PCB jack as shown.
- () R16: 10 k Ω control (#10-1132). First bend the three leads of the control down as shown in A. Match the leads on the control with the holes in the circuit board. Then push the control down so it is positioned as shown in B.

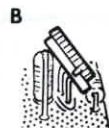

PICTORIAL 1-11

START →

- () R35: 1 M Ω , 1-watt (brn-blk-grn). Solder the leads to the foil and cut off the excess lead lengths.

NOTE: Install the following transistors in the manner shown. First line up the flat on the transistor with the outline of the flat on the circuit board. Insert the transistor leads into the corresponding holes. Solder each lead to the foil and cut off the excess lead lengths.

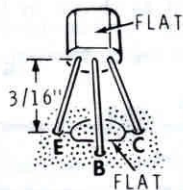

- () Q4: 2N3904 transistor (#417-875).
- () Q5: 2N3904 transistor (#417-875).
- () Q3: 2N3904 transistor (#417-875).

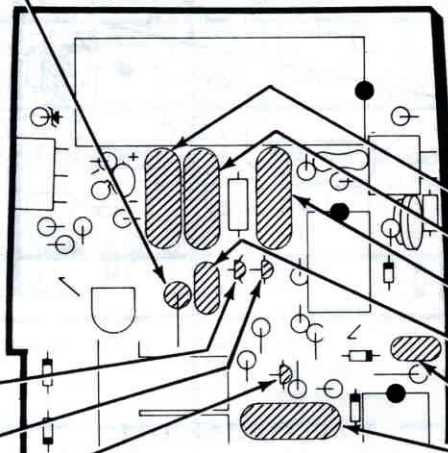

PICTORIAL 1-12

CONTINUE ↘

NOTE: When you install ceramic or Mylar capacitors, do not push the insulated portion of the leads into the circuit board holes. This could make it difficult to solder the leads to the foil. The leads of Mylar capacitors may be coated with a clear film. If you have any soldering problem with these capacitors, apply more heat to the leads to melt this film.

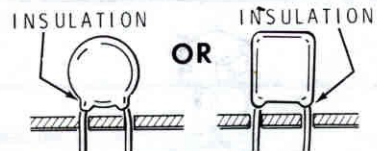

- () C12: .47 μ F Mylar.
- () C13: .47 μ F Mylar.
- () C14: .47 μ F Mylar.
- () C16: .047 μ F Mylar.
- () C9: .047 μ F Mylar.
- () C5: .022 μ F Mylar.
- () Solder the leads to the foil and cut off the excess lead lengths.

START 

NOTE: On the following Pictorials, you will install components in section B of the circuit board. See Pictorial 1-1 (Illustration Booklet, Page 5).

NOTE: When you install diodes, as in the following steps, be sure you position the banded end of each diode as it is shown on the circuit board.

() D8: 1N4149 diode (#56-56).

() D9: 1N4149 diode (#56-56).

() D3: 1N4149 diode (#56-56).

() R7: 100 k Ω (brn-blk-yel). Mount this resistor horizontally.

() R6: 270 Ω (red-viol-brn).

() R5: 100 Ω , .1%.

() Solder the leads to the foil and cut off the excess lead lengths.

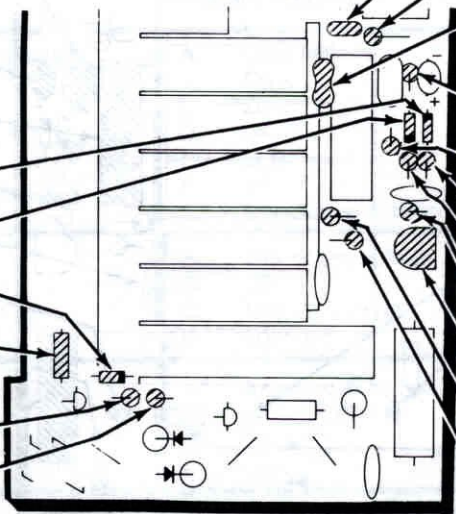

PICTORIAL 1-13

CONTINUE 

() C6: .01 μ F Mylar.

() R22: 1000 M Ω , 1/2-watt (brn-blk-gry).

() C3: 470 pF mica. NOTE: The circuit board may be marked with a different value at this location.

() R28: 100 k Ω (brn-blk-yel).

() R31: 1 M Ω (brn-blk-grn).

() R29: 6810 Ω , 1% (blu-gry-brn-brn).

() R32: 6810 Ω , 1% (blu-gry-brn-brn).

() R33: 3010 Ω , 1% (org-blk-brn-brn).

() R34: 500 Ω control (#10-1140).

() R3: 9 Ω , .1%.

() R2: 90 Ω , .1%.

() Solder the leads to the foil and cut off the excess lead lengths.

START →

NOTE: Install the following transistors in the manner shown. First line up the flat on the transistor with the outline of the flat on the circuit board. Insert the transistor leads into the corresponding holes. Solder each lead to the foil and cut off the excess lead lengths.

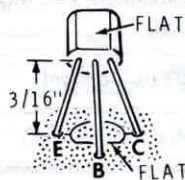

() Q2: MPSA05 transistor (#417-864).

() Q1: 2N3904 transistor (#417-875).

() RT1: 1000 Ω thermistor (#9-95). Position the thermistor body 1/8" above the circuit board before you solder the leads to the foil. Cut off the excess lead lengths.

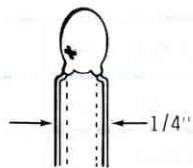
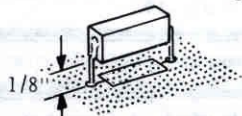
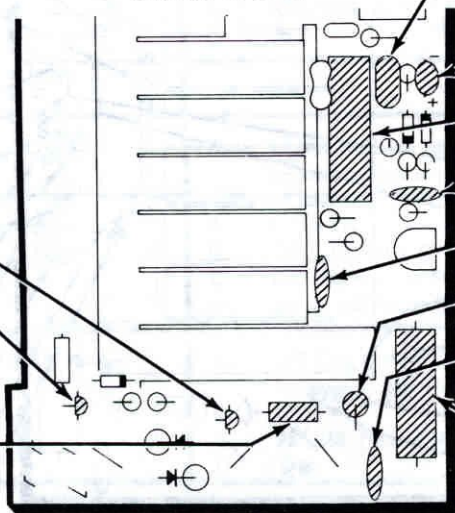
**Detail 1-14A****PICTORIAL 1-14****CONTINUE** →

() C7: .047 μ F Mylar.

NOTE: Be sure to position the positive (+) or dot marked lead on the following capacitor toward the positive (+) mark on the circuit board.

() C8: 39 μ F tantalum. Refer to Detail 1-14A and form the leads to the indicated spacing.

() RN2: Resistor network (#9-89).

() C11: 680 pF ceramic.

() C2: 3.9 pF ceramic.

() R4: 100 k Ω , 1-watt (brn-blk-yel).

() C1: .75 pF spark gap ceramic.

() R1: 1000 Ω , 2-watt (brn-blk-red). Mount this resistor horizontally and position the resistor body 1/8" above the circuit board.

() Solder the leads to the foil and cut off the excess lead lengths.

START →

- () RN1: Resistor network (#9-94). Push the network down against the circuit board before you solder the leads to the foil. Then cut off the excess line lengths.

- () Mount a 6-32 × 3/4" spacer on the component side of the circuit board. Use a 6-32 × 5/16" screw and a #6 lockwasher. NOTE: Be sure that you do not confuse the spacer with one of the banana jacks.

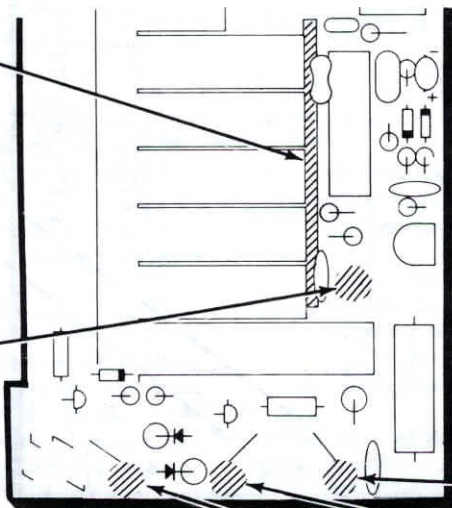
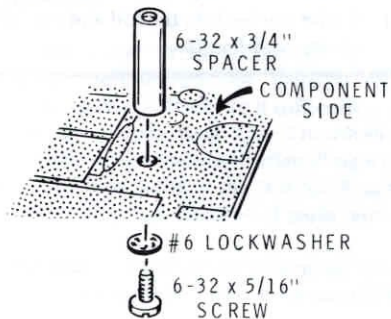

PICTORIAL 1-15

CONTINUE →

NOTE: Mount banana jacks at three locations on the component side of the circuit board. Use a 6-32 × 5/16" screw and two #6 lockwashers to mount each jack. Tighten the screws firmly.

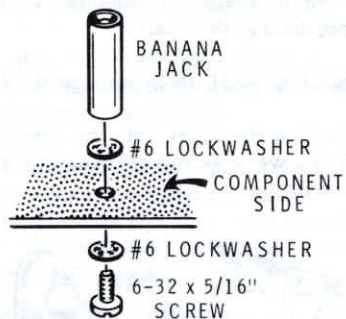

- () J1: Banana jack.

- () J2: Banana jack.

- () J3: Banana jack.

START ▾

NOTE: Use the following procedure when you install diodes in the following steps:

1. Hold the diode lead with pliers so you do not damage the diode.
2. Bend the lead before you install the diode.
3. Position the diode with the banded end down over the circle outline on the circuit board.

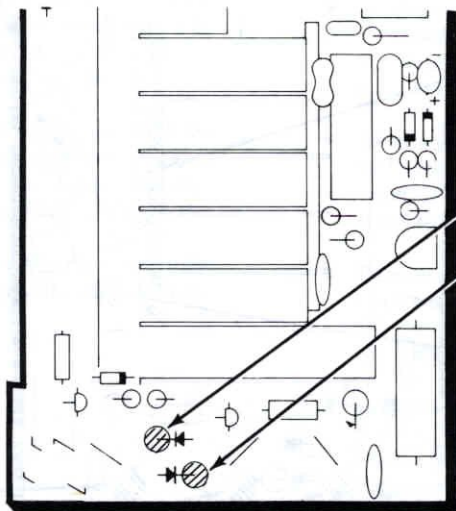
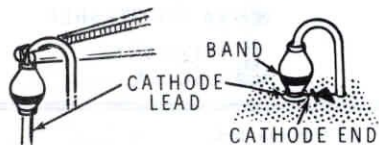
**CONTINUE** ▾

- () D1: Selected 1N5624 diode (#57-613).
- () D2: Selected 1N5624 diode (#57-613).
- () Solder the leads to the foil and cut off the excess lead lengths.

PICTORIAL 1-16

START 

- () Locate the pushbutton switch assembly. Position it as shown in Detail 1-17A (Illustration Booklet, Page 6). Then cut off the three switch pins indicated in the Detail.

- () SW1-SW8: Install the switch assembly on the circuit board by carefully inserting all the switch pins into their mounting holes. Then push the assembly onto the circuit board.

Make sure the crimped portion of each pin is fully seated against the circuit board. Then turn the circuit board over and solder two pins on each end of the switch assembly. Check the switch assembly and make sure it is straight. Then solder the other switch pins to the foil.

NOTE : Make sure the lead of this resistor does not make contact with the metal switch bracket.

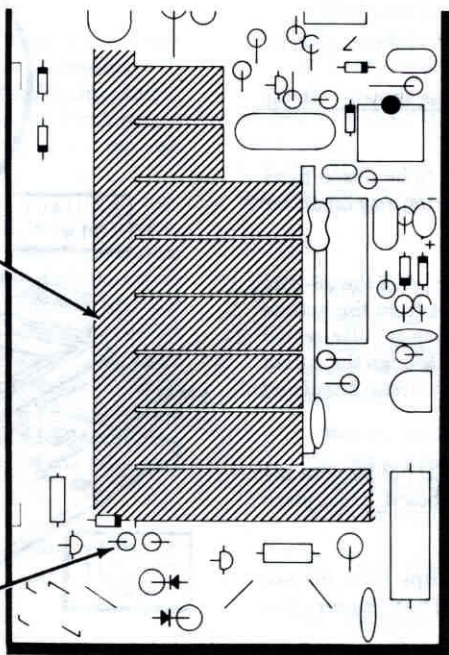

PICTORIAL 1-17

CIRCUIT BOARD CHECKOUT

Carefully inspect the foil side of the circuit board for the following most commonly made errors.

- () Unsoldered connections.
- () Poor solder connections.
- () Solder bridges between foil patterns.
- () Protruding leads which could touch together when the circuit board is installed later.

Refer to the illustration where the parts were installed as you make the following visual checks.

- () Transistors for proper **type** and **installation**.
- () Tantalum capacitors for the correct position of the positive (+) or dot marked lead.
- () Diodes for the proper **type** and **installation**.

Set the main circuit board aside temporarily.

Display Circuit Board

Refer to Pictorial 2-1 (Illustration Booklet, Page 6) for the following steps.

- () Make sure you position the display circuit board as shown with the part number (#85-2176) side facing down.

CAUTION: Do NOT allow the ends of the ribbon cable to be flexed more than necessary before or after you install it. Excessive flexing may break one or more pins.

- () Refer to Detail 2-1A and match the pins at either end of the 28-wire ribbon cable with the corresponding row of holes from the **bottom** side of the display circuit board. Be sure the cable is fully seated against the circuit board and all the pins protrude through the circuit board. Then solder all the pins to the **top** side of the circuit board and cut off the excess pin lengths.
- () Refer to Detail 2-1A and line up the tabs on the LCD holder with the corresponding small holes on the display circuit board. Then place the LCD holder on the circuit board.
- () Carefully remove the two elastomeric contact strips from the envelope containing the LCD socket assembly. **CAUTION:** Be sure you do not stretch the contact strips.

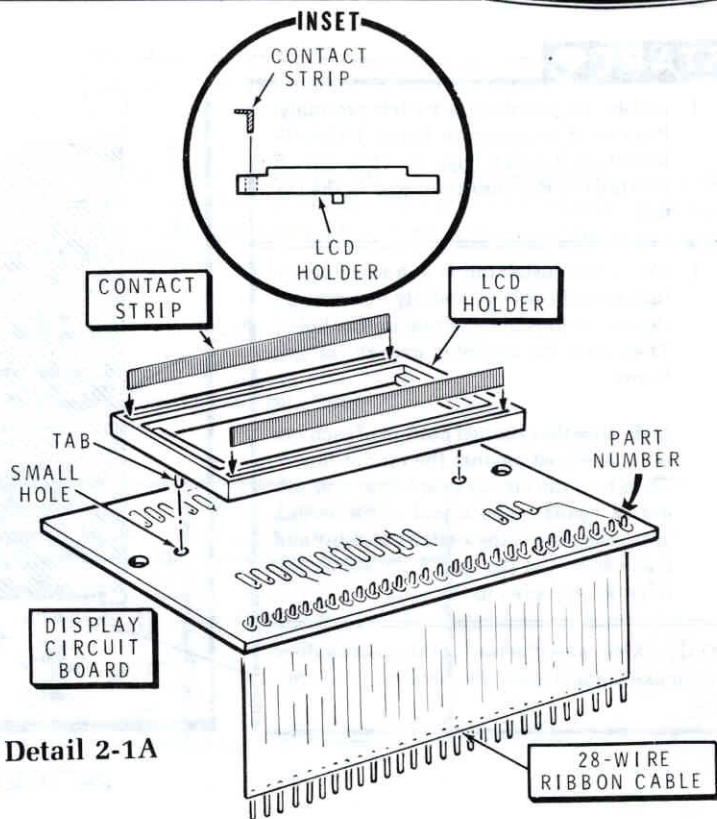

Detail 2-1A

- () Refer to Detail 2-1A (and its inset drawing if you received the optional type contact strip) and insert a contact strip either way in each of the two slots in the LCD holder. Carefully push each contact strip so the entire length rests against the circuit board.
- () Make sure the window is free from fingerprints and dust.
- () Refer to Detail 2-1B and place the window next to the bezel. Position the window so the side with the painted border faces down. Then slide the window into the grooves in the bezel. Center the window in the bezel.

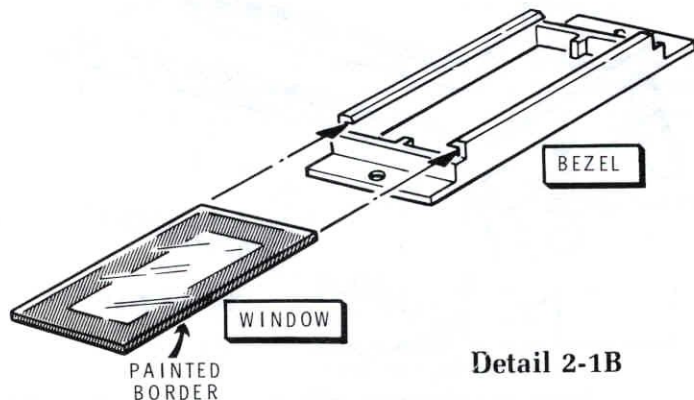

Detail 2-1B

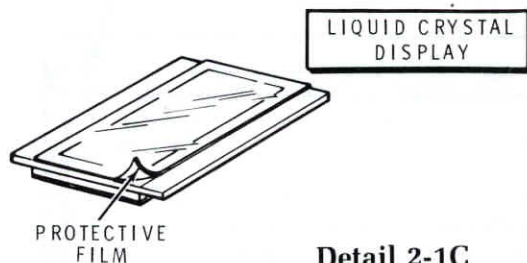

Detail 2-1C

CAUTION: The liquid crystal display (LCD) is supplied with a clear, protective film. In the following step, be sure you only remove this protective film. Do **NOT** remove the top surface, which is a plastic polarizer sheet. Also, be sure you do not scratch the polarizer sheet.

- () Refer to Detail 2-1C while you hold the liquid crystal display between your index finger and the thumb on one hand. Carefully lift just the corner of the clear, protective film from the top of the display with the other hand as shown in the Detail. Make sure the black border is still visible under the corner you just lifted. If so, completely remove the protective film. If not, push the polarizer sheet firmly down; then remove the protective film.

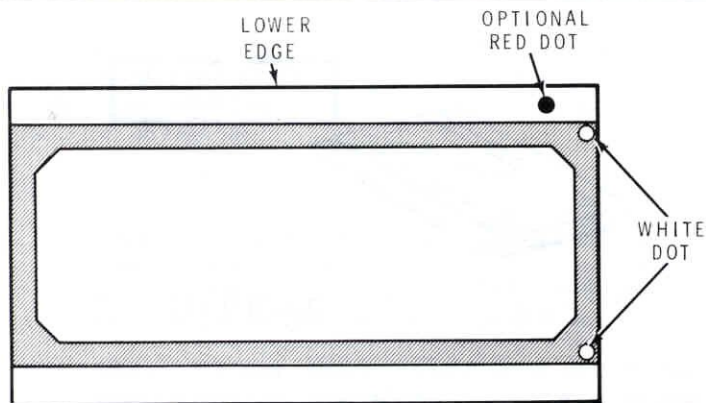

Detail 2-1D

- () Refer to Detail 2-1D and locate the identification marks near one edge on the top surface of the liquid crystal display. This identifies the lower edge of the display.
- () LCD1: Refer to Detail 2-1E and place the display in the LCD holder so the identification mark on the display is near the lower edge of the circuit board.
- () Mount the bezel to the display circuit board assembly as shown in Detail 2-1E. Use a display bracket, a 4-40 × 3/8" screw, a #4 lockwasher and a 4-40 nut at AA and AB. Only tighten the hardware finger tight at this time.

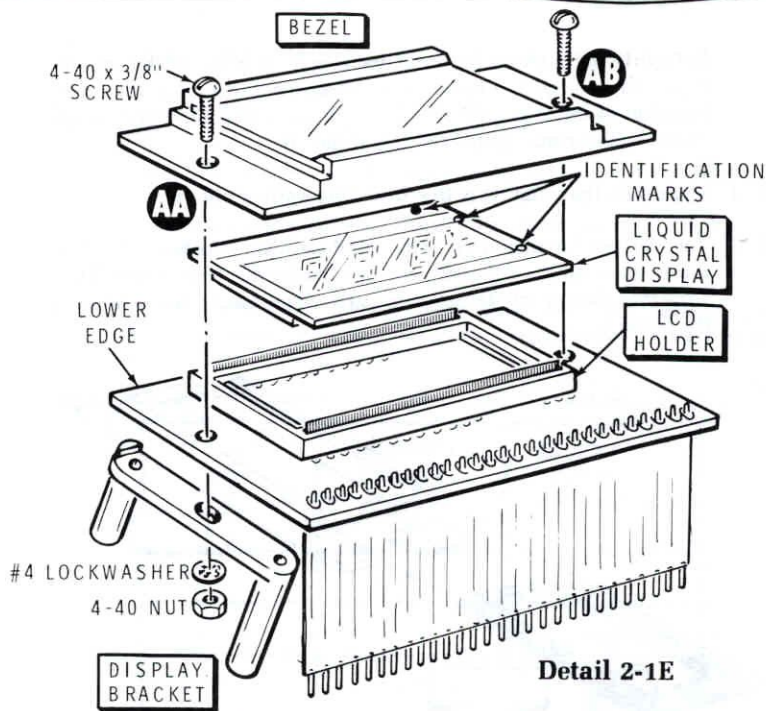

Detail 2-1E

- () Set the display circuit board assembly aside until it is called for in a step.

General Assembly and Wiring

WIRING

Refer to Pictorial 2-2 (Illustration Booklet, Page 7) for the following steps.

- () Refer to Detail 2-2A and dress the four wires of the battery connector/fuseholder assembly so they exit from the assembly as shown.

BATTERY CONNECTOR/
FUSEHOLDER ASSEMBLY

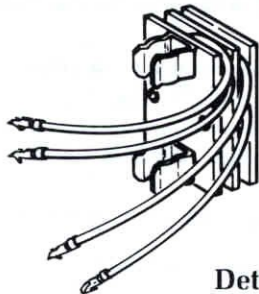

Detail 2-2A

NOTES:

1. You will connect the wires of the battery connector/fuseholder assembly to the main circuit board in the following steps. Notice the small connector at each wire end. Insert each wire into the correct circuit board hole from the component side of the board. Push each connector until it snaps in place. Then solder each wire connector to the foil on the other side of the circuit board.
2. In the following steps "S-" with a number, such as (S-1) means to solder the connection. The number following the "S" tells how many wires are at the connection.

Connect the wires of the battery connector/fuseholder assembly to the main circuit board as follows:

- () White connector wire to indicated hole marked F1 (S-1).
- () Red wire connector to hole marked RED (S-1).
- () Yellow wire connector to indicated hole marked F1 (S-1).
- () Black wire connector to hole marked BLK (S-1).

NOTE: To prepare the lengths of wire in the following steps, cut the blue wire to the specified length. Then remove $1/4"$ of insulation from each end. Position the wires as shown in the Pictorial and push them down against the switch assembly.

() Prepare the following lengths of blue wire:

- One $1-1/8"$
- One $1"$
- One $2-1/4"$

() Connect a $1-1/8"$ blue wire from SW4 lug 9 (S-1) to SW5 lug 12 (S-1).

() Connect a $1"$ blue wire from SW4 lug 12 (S-1) to SW5 lug 3 (S-1).

() Connect a $2-1/4"$ blue wire from SW3 lug 9 (S-1) to SW6 lug 12 (S-1).

NOTE: When clear wire is called for in the following steps, use the inner conductor of the length of shielded cable supplied. Refer to Detail 2-2B for information on how to remove the inner conductor from the shielded cable. Remove $1/4"$ of insulation from each conductor end. Position the wires as shown in the Pictorial and push them down against the switch assembly.

() Prepare the following lengths of clear wire:

- One $3-1/2"$
- One $4"$

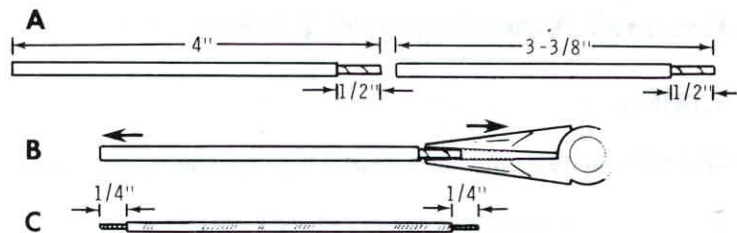
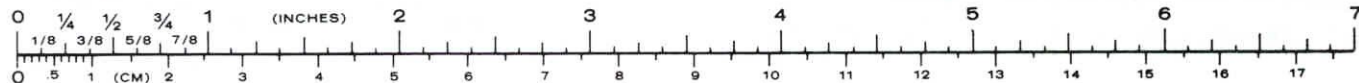

1. CUT THE SHIELDED CABLE TO THE INDICATED LENGTHS AS SHOWN IN A. THEN REMOVE $1/2"$ OF OUTER INSULATION FROM EACH CABLE LENGTH.
2. USE A PAIR OF PLIERS TO REMOVE THE INNER CONDUCTOR FROM EACH CABLE LENGTH AS SHOWN IN B. DISCARD THE OUTER INSULATION, THE SHIELD WIRE AND THE ALUMINUM WRAPPING.
3. REMOVE $1/4"$ OF INSULATION FROM BOTH ENDS OF EACH INNER CONDUCTOR AS SHOWN IN C.

Detail 2-2B

() Connect a $3-1/2"$ clear wire from SW3 lug 5 (S-1) to SW8 lug 7 (S-1).

() Connect a $4"$ clear wire from SW 1 lug 5 (S-1) to SW8 lug 8 (S-1).

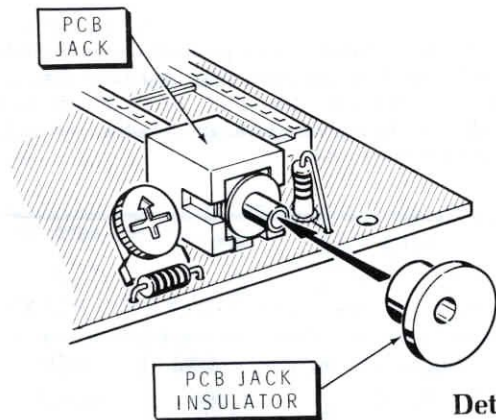

Detail 2-2C

- () Refer to Detail 2-2C and press the PCB jack insulator onto the PCB jack as shown.
- () Locate the display circuit board assembly.
- () Refer to Detail 2-2D and match the pins at the free end of the 28-wire ribbon cable with the corresponding row of holes from the component side of the main circuit board. Be sure the cable is fully seated against the circuit board and all the pins protrude through the circuit board. Then solder all the pins to the circuit board and cut off the excess pin lengths.

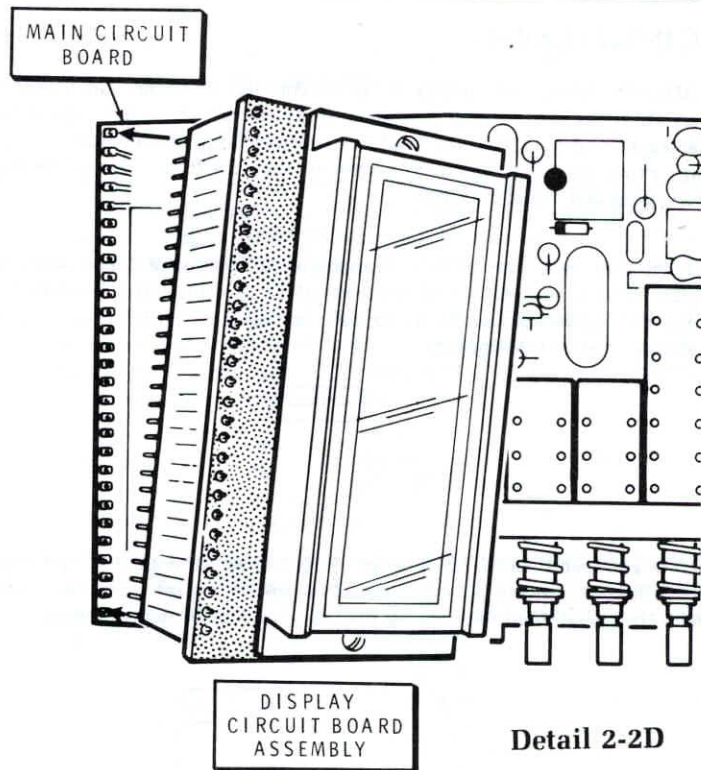

Detail 2-2D

IC INSTALLATION

CAUTION: Integrated Circuits (IC's) are complex electronic devices that perform many complicated functions in the circuit. These devices can be damaged during installation. Read all of the following information, including "Protected IC's," before you remove any IC's from their protective packaging and install any IC's.

The pins on the IC's are bent out at an angle, so they do not line up with the holes in the IC socket. Do NOT try to install an IC without first bending the pins as described below. To do so may damage the IC pins or the socket, causing intermittent contact.



Before you install an IC, lay it down on its side as shown below and very carefully roll it toward the pins to bend the lower pins into line. Then turn the IC over and bend the pins on the other side in the same manner.



Make sure that the pin 1 end of the IC is positioned over the index mark on the circuit board. (Refer to Detail 2-3A). Also, make sure that all of the pins are started into the socket. Then press the IC firmly into the socket. NOTE: An IC pin can become bent under the IC and it will appear as though it is correctly installed in the socket.

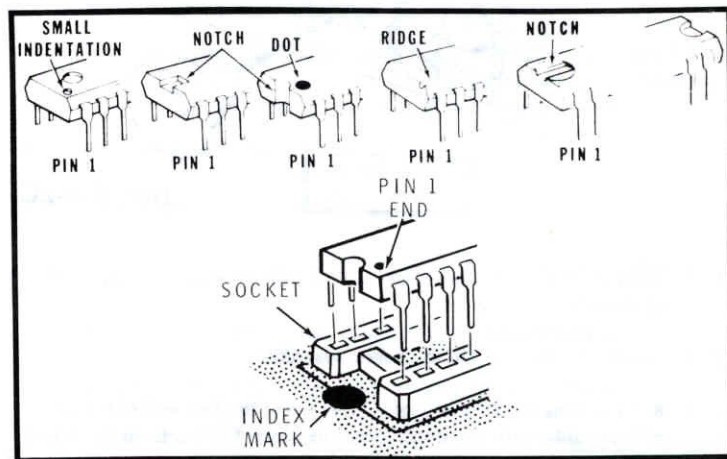

Detail 2-3A

Protected IC's

Two of the IC's that you will install are called "protected IC's." These IC's can be easily damaged by static electricity. Once you remove a protected IC from its protective foam packing, do NOT lay the IC down or let go of it until it is installed in its socket.

When you bend the leads of a protected IC, hold the IC in one hand and place your other hand on your work surface before you touch the IC to your work surface. This will equalize the static electricity between the work surface and the IC.

NOTE: Once the IC is installed, it is protected by the circuit resistance.

Refer to Pictorial 2-3 (Illustration Booklet, Page 8) for the following steps.

- () Position the circuit board assembly with the component side up, as shown in the Pictorial.

NOTE: In the following steps, when you install an integrated circuit, refer to Detail 2-3A, remove the IC from its packaging material (if necessary), and install the IC as shown.

- () U2: Install a TL061CP IC (#442-679) at U2.
- () U3: Install a CD4030 protected IC (#443-917) at U3. Refer to the paragraph above concerning protected IC's.
- () U4: Install a 7106 protected IC (#442-678) at U4. Refer to the paragraph above concerning protected IC's.

CASE BOTTOM ASSEMBLY

Refer to Pictorial 2-4 (Illustration Booklet, Page 9) for the following steps.

- () Cut the 1" × 2" piece of insulating paper into three equal pieces (each approximately $2\frac{1}{32}$ " × 1"). Pull off the backing paper from each piece of insulating paper. Then press each paper into place inside the case bottom at the locations shown in Detail 2-4A (Illustration Booklet, Page 10).
- () Peel the paper backing from one piece of rubber gasket. Then refer to Detail 2-4B (Illustration Booklet, Page 11) and press this piece to the inside of the case bottom at the location shown (the longer side).
- () Refer to Detail 2-4B and line up standoffs A, B, and E on the inside of the case bottom with the corresponding holes in the shield. Then slip the shield over the standoffs and push it down against the case bottom.
- () Refer to Detail 2-4C (Illustration Booklet, Page 12) and mount the display circuit board assembly to the main circuit board. Use #5 fiber flat washers and #4 × 3/8" self-tapping screws at AC, AD, AE, and AF. Do NOT overtighten the screws.
- () Refer to Detail 2-4D (Illustration Booklet, Page 13) and place the circuit board assembly in the case bottom at an angle by inserting the slide switch lever through hole SW9. Also, line up bosses C and D with the corresponding holes in the main circuit board. Do not drop the circuit board down yet.

- () Refer to Detail 2-4D and install the switch cover plate by first sliding it under the actuators for the pushbutton switch assembly. Then drop the cover plate in place so it rests inside the slots in the side of the case bottom. Finally, push the circuit board assembly down over bosses C, D, and F. Make sure the PCB jack insulator is on the inside of the case bottom.
- () Refer to Detail 2-4E (Illustration Booklet, Page 14) and place a knob next to a switch actuator as shown. Line up the square hole in the knob with the end of the actuator. Then push the knob onto the actuator until the knob snaps in place.
- () In a similar manner, install a knob on each of the seven remaining switch actuators.
- () Tighten the hardware at AA and AB.
- () Be sure the OFF-ON switch of your Multimeter is in the OFF position.
- () F1: Refer to Detail 2-4E and install the 2-ampere fuse in the fuseholder.
- () Fold the shield over the pushbutton switch assembly. Secure the shield to the 6-32 \times 3/4" spacer mounted on the main circuit board. Use a #6 flat washer and a 6-32 \times 5/16" screw. Do **NOT** overtighten the screw.

Refer to Pictorial 2-5 for the following steps.

- () Position the cabinet bottom as shown.

NOTE: In the following step, be sure you position the label as shown in the Pictorial before you press the label in place.

- () Carefully peel away the backing paper from the Caution label. Then press the label into the recessed area in the case bottom.
- () Install the bail in the recessed area in the case bottom by first pressing the open end of the bail slightly together with one hand. Line up each wire end of the bail with respective holes G and H in the case bottom. Then release the pressure on the bail. Finally, push the bail so it pivots into the recessed area and is held in place by the catch.

Proceed to "Test Lead Preparation."

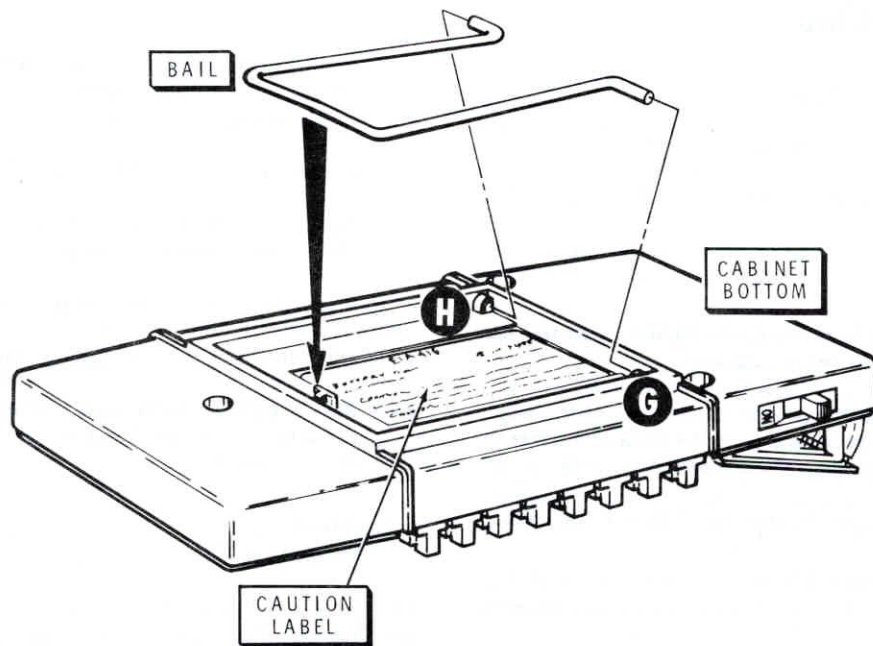

PICTORIAL 2-5

Test Lead Preparation

Refer to Pictorial 3-1 for the following steps.

- () Locate the two 36" test leads you set aside earlier.
- () Remove 1/2" of insulation from one end of the red test lead.
- () Refer to Part A of the Pictorial and install a test probe on this end of the red test lead as follows:
 1. Unscrew the insulator from the probe tip and insert the wire through the smaller hole in the insulator.
 2. Twist the fine wires together and insert them through the hole in the probe. Then form the wires around the probe and screw the probe collar over them. Screw the insulator back on the probe.
- () Remove 3/4" of insulation from the free end of the red test lead.
- () Refer to Part B of the Pictorial and insert this end of the red test lead into a banana plug as shown. Then bend the wire back flat against the plug body.
- () Place the banana plug on a small phillips screwdriver (or similar tool) and push a red plug insulator onto the plug and wire until the insulator snaps into place.
- () Remove 3/4" insulation from one end of the black test lead.
- () Again refer to Part B of the Pictorial and install a banana plug and black plug insulator on this end of the black test lead.
- () Remove 1/4" insulation from the free end of the black test lead.
- () Insert the black test lead through the alligator clip insulator.
- () Refer to Part C of the Pictorial and install an alligator clip on this end of the black test lead. Twist the fine wires together and insert them into the alligator clip (S-1).
- () After the clip has cooled, slip the alligator clip insulator down over the alligator clip.

This completes the assembly of your Multimeter. The case top will be installed later. Proceed to "Operational Tests."



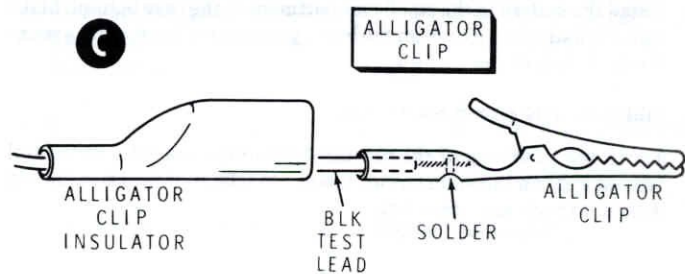
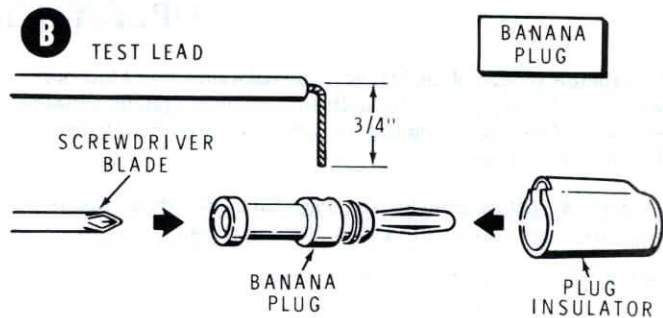
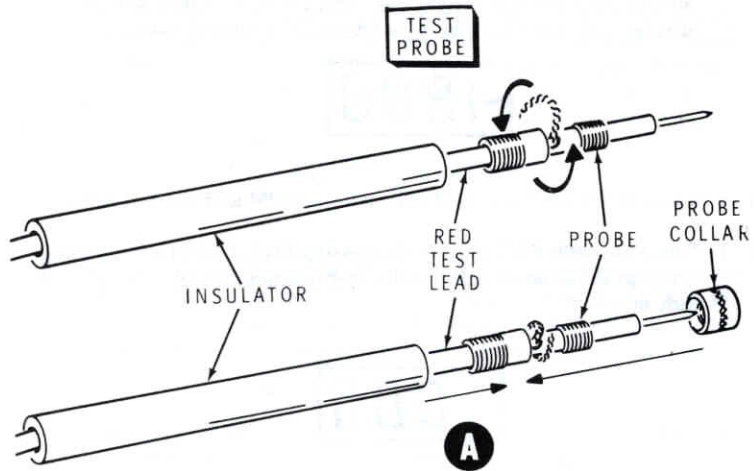

PICTORIAL 3-1

OPERATIONAL TESTS

The purpose of this section of the Manual is to make sure your Multimeter operates properly. If you have any difficulty in the following steps, slide the OFF-ON switch to OFF and disconnect the battery. Then refer to "In Case of Difficulty" section on Page 63.

Refer to Pictorial 4-1 (Illustration Booklet, Page 15) to identify the points on the main circuit board called out in the following steps.

- () Position all switch buttons out as shown.
- () Plug the battery connector onto the 9-volt battery (not supplied).
- () Install the battery in the small compartment in the case bottom. Make sure the four wires exit from the battery connector/fuseholder assembly as shown in the Pictorial.
- () Slide OFF-ON switch SW9 to ON.
- () Touch the probe tip of the red test lead to the red wire at the foil labeled RED on the main circuit board. CAUTION: Make sure the tip does not touch any other foil.

- () Momentarily touch the banana plug at the other end of the black test lead to the exposed lead of R21 [470 k (yel-viol-yel).] The display should indicate as shown below. CAUTION: You may damage the display if this connection is maintained for several minutes.



- () Connect the black test lead between the COM and the V/ Ω jacks.
- () Select the 1000 VDC range by depressing SW3. Leave the remaining seven pushbutton switches in the out position. The display should indicate:



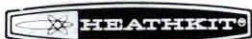

NOTE: In the following steps, the negative sign may flash on and off on all the DC voltage ranges. In addition, the right hand digit may occasionally show a "1."

- () Select the 200 VDC range by depressing SW4 only. The display should indicate:

- () Select the 20 VDC range by depressing SW5 only. The display should indicate:

- () Select the 2 VDC range by depressing SW6 only. The display should indicate:

- () Select the 200 k Ω range by depressing SW4 and SW8 only. The display should indicate:

- () Remove the black test lead that is connected between the COM and the V/ Ω jacks. The display should indicate:

- () Slide the OFF-ON switch to OFF.

This completes the "Operational Tests." Proceed to "Calibration."

CALIBRATION

NOTES:

1. New Multimeters may exhibit a small amount of calibration drift due to component "aging". Therefore, we suggest that you recalibrate your Multimeter after an initial period of use; six months, for example. You may also wish to recalibrate your Multimeter regularly at six to twelve months intervals, or as required, to insure optimum accuracy during use.
2. If you do not obtain the correct indication in any of the following steps, refer to the "In Case of Difficulty" section. Locate and repair any problem before you continue with the calibration.

() Make sure the converter/charger is disconnected from your Multimeter.

The following characteristics of the display, which occur during calibration, are normal:

1. Overrange is indicated by a "1" in the left-end digit with the remaining digits blanked.

2. When you select an AC voltage range, the display reading may take several seconds to settle.

NOTE: Two methods of calibration are provided in this section of the Manual. The first method ("Built-in Standards Method") uses the internal, supplied references. The second method (on Page 48) uses laboratory-grade standard references.

To perform the calibration with laboratory-grade standard references, you will need the following equipment:

1. A DC voltage standard that provides plus and minus 190 mV DC with an accuracy greater than $\pm .05\%$.
2. An AC voltage standard that provides 190 mV AC rms with an accuracy within $\pm .1\%$. The output must be a low distortion 100 Hz sine-wave.

Choose one of the calibration methods and perform the steps for that method only.

Built-In Standards Method

DC CALIBRATION

Refer to Pictorial 4-1 (Illustration Booklet, Page 15) for the following steps.

- () Locate the DC calibration label; it will be used in the following steps.
- () Plug the red test lead into the V/Ω jack.
- () Select the 2VDC range by depressing SW6 only.
- () Slide the OFF-ON switch to ON.
- () Touch the red test probe tip to TP1 on the component side of the main circuit board and adjust the DC CAL control (R13) so the meter displays the number on the DC calibration label. NOTE: An occasional variation of ± 1 digit is acceptable.
- () Remove the probe tip from TP1.

AC CALIBRATION

Refer to Pictorial 4-1 (Illustration Booklet, Page 15) for the following steps.

- () Set the AC REF ADJ control fully counterclockwise, as viewed from the front of the control.
- () Select the 200 mV DC range by selecting SW7 only.
- () Touch the red test probe tip to TP2 and adjust the AC REF ADJ control (R16) for a reading of 171.2. NOTE: An occasional flash of ± 2 digits is acceptable.
- () Select the 200 mV AC range by depressing SW1 and SW7 only.

NOTE: Allow sufficient time for the display to stabilize before you proceed to the next step.

- () Touch the red test probe tip to TP2 and adjust the AC CAL control (R34) for a reading of 190.0 NOTE: An occasional variation of ± 2 digits is acceptable.
- () Remove the probe tip from TP2.

This completes the "Calibration" of your Multimeter. However, after it has been in use for some time - six months for example - you may wish to touch up the calibration to remove any small "aging" drift.

Laboratory Standards Method

Make sure that your calibration standards are at least 5 times more accurate than the Laboratory Standards Accuracy Specification on Pages 70 and 71. For example, to obtain an accuracy of $\pm .25\%$, the Laboratory Standard must be accurate to within $\pm .05\%$.

DC CALIBRATION

Refer to Pictorial 4-1 (Illustration Booklet, Page 15) for the following steps.

- () Select the 200 mV DC range by depressing SW7 only.
- () Slide the OFF-ON switch to ON.
- () Connect the black test lead to the COM jack and the red test lead to the V/ Ω jack.
- () Connect the Multimeter test leads to a +190.0 mV source.
- () Adjust the DC CAL control (R13) for display reading of 190.0 NOTE: An occasional variation of ± 1 digit is acceptable.
- () Disconnect the test leads from the +190.0 mV source.

AC CALIBRATION

Refer to Pictorial 4-1 for the following steps.

- () Select the 200 mV AC range by depressing SW1 and SW7 only. Allow the Multimeter display time to stabilize.
- () Connect the Multimeter test leads to a 190.0 mV, 100 Hz source.
- () Adjust the AC CAL control (R34) for a display reading of 190.0. NOTE: An occasional variation of ± 1 digit is acceptable.
- () Disconnect the test leads.

This completes the "Calibration" of your Multimeter. However, after it has been in use for some time — six months for example — you may wish to touch up the calibration to remove any small "aging" drift.

Proceed to "Final Assembly."

FINAL ASSEMBLY

Refer to Pictorial 5-1 (Illustration Booklet, Page 16) for the following steps.

- () Refer to Detail 5-1A (Illustration Booklet, Page 17) and carefully apply the Function/Range label to the case top. First, if necessary, remove the cutout portions of the label. Then peel away the protective backing paper. Finally, press the label into place on the case top.

- () Position the case top as shown in the Pictorial.

- () Use a pair of scissors to cut off 1/8" from only one side of the remaining piece of rubber gasket. Peel away the backing paper from the larger gasket and press the gasket to the inside of the case top at the location shown (the longer side). Discard the cutoff piece.

- () Peel away the paper backing from the DC Calibration label you set aside previously. Then press the label to the inside of the case top at the location shown.

NOTE: The blue and white label that you will install in the following step shows the Model number and Production Series number of your kit. Refer to these numbers in any communications you have with the Heath Company about this kit.

- () Carefully peel away the paper backing from the blue and white label. Then press the label to the inside of the case top at the location shown.

- () Position the case top over the case bottom as shown in the Pictorial. Press the case halves together and make sure the printed border on the display window is centered in the case top window opening. You may have to loosen the two 4-40 × 3/8" screws on the display circuit board assembly to properly position the display circuit board. Be sure to retighten the two screws.

- () Being careful not to pinch any wires or the PCB jack insulator between the case halves, secure the case halves together with three #6 × 5/8" self-tapping screws.

This completes the Assembly of your Digital Multimeter.

OPERATION

This portion of the Manual is divided into three parts. The first part, "General," provides information concerning various precautions you must observe when using the Multimeter. The second part, "Operating Characteristics," includes operating information that applies to the various functions of the Multimeter. The third part, "Measurements," provides specific

operating instructions for each function of the Multimeter, along with guidelines and techniques for providing optimum measurement accuracy.

NOTE: Be sure you read all of the "General" and "Operating Characteristics" sections before you use the Multimeter.

General

Refer to Pictorial 6-1 (Illustration Booklet, Page 16) for a brief description of each switch and input jack.

The front of the Multimeter has two standard operator warnings. These are:



This symbol advises the operator to familiarize himself with the operation section of this Manual.



This symbol warns the operator that there may be dangerously high voltage at this location, or that there is a voltage limitation to be considered when using this terminal.

Specific limitations of the Multimeter are included in the VDC, VAC, mA DC, and mA AC portions of the "Measurement" section concerning these symbols.

SAFETY PRECAUTIONS

You may often use your Multimeter to check, maintain, and repair electronic equipment that contains DANGEROUSLY HIGH VOLTAGES. Because of this danger, always observe the safety procedures listed below.

1. Always handle the test probe by the insulated portion only. Be careful not to touch the exposed tip.
2. When you measure high voltages, turn off the power to the equipment to be tested before you connect the test leads. If this is not possible, be very careful to avoid accidental contact with any object that could provide a ground return (circuit completion) path.
3. If at all possible, use only one hand when you make tests on equipment that is turned on. Keep one hand in your pocket or behind your back to help avoid accidental shock.

4. If possible, insulate yourself from ground while you make measurements. Stand on a properly insulated floor or floor covering.

LIQUID CRYSTAL DISPLAY

The liquid crystal display (LCD) is a rugged and reliable device which should provide years of service. You can extend the display lifetime by observing the following practices:

- A. Protect the display from extended exposure to bright sunlight.
- B. Do **NOT** store your Multimeter in extremely hot, humid, or cold environments. Refer to the "Storage Temperature" specification on Page 74 of this Manual.
- C. Do **NOT** apply excessive pressure or stresses to the LCD.

POWER SOURCES

You may use either of two power sources for the Multimeter. We recommend an **alkaline** power cell, NEDA type # 1604 for battery power. You may purchase the optional 9-volt Heathkit Converter/Charger, Model PS-2350 for 120 VAC operation or Model PS-2450 for 220 VAC operation, if you wish to power the Multimeter without a battery or if you intend to use both.

When you have access to a conventional AC power source, and if you have the proper Converter/Charger, merely push the subminiature phone plug into PCB jack J4 and connect the line cord plug to an AC outlet. **NOTE:** In this Multimeter, the Converter/Charger is used as a **Battery Eliminator**; it will **not** charge your battery, which is disconnected from the Multimeter circuitry when the Converter/Charger is connected to J4.

BATTERY LIFE

Your Multimeter is designed to operate on an inexpensive 9-volt battery (NEDA 1604). If you use an **alkaline** battery, you can expect a typical operating life of up to 200 hours. A zinc-carbon battery will provide 100-150 hours of operation.

CAUTION: You should replace the battery annually or when it is discharged to protect your Multimeter from battery leakage or rupture. Several battery manufacturers will repair any device damaged by their batteries — it is advisable to use a battery with such a guarantee. It is further advisable to remove the battery during extended storage.

Operating Characteristics

The LCD provides a continuous indication of your Multimeter's operating status: overload, low battery, and normal operation.

INPUT OVERLOAD PROTECTION

All functions are protected against input overloads, either by resistor-diode networks, or through fuse action as long as the overload is within the specified limits. (See Page 70).

OVERLOAD/OVERRANGE INDICATION

An overload/overrange condition is indicated when all display digits, except the most significant digit ("1"), are blanked. This does not necessarily mean that the Multimeter is being exposed to a damaging input condition. For example, when you measure resistance, an open-input condition will cause an overload/overrange condition.

NOTE: The minus sign (-) may flash momentarily as your Multimeter recovers from an overload/overrange condition. You will most likely see this in the ohms mode when the open circuit test leads are connected across an in-range resistor. If the minus sign remains on for in-range ohms readings, a voltage is present at the input terminals due to charged capacitors, etc. For this reason, you will observe incorrect resistance readings.

LOW BATTERY INDICATION

When approximately 80% of the useful battery life has been exhausted, a "LO BAT" indication will appear in the upper left-hand corner of the display. When the low battery indication first appears, at least 20 hours of operating time will remain before the accuracy of your Multimeter will be affected (if an alkaline battery is being used).

OPEN INPUT DISPLAY

A significant voltage may be displayed on the lowest VDC or VAC ranges if the test leads are not connected to a measurement point (or to each other). This is normal and will not produce a measurement error when the leads are connected to a low impedance (less than 1 M Ω for VDC, or 100 k Ω for VAC) measurement point.

± 1 COUNT

It is normal for the right-hand digit of the display to alternate one digit above and below a reading on successive conversions.

USE WITH ACCESSORY PROBES

High Voltage Probe

You can use this Multimeter with a high voltage probe on VDC only. The probe must be designed for a meter that has a 10 M Ω input impedance. (A high voltage probe of this type is available from the Heath Company.) The probe should be connected between the V/ Ω and COM sockets. The Multimeter should be set for a range governed by the voltage division ratio of the probe. If, for example, you are using a 100:1 probe and you expect the voltage to measure approximately 14,000 VDC, the Multimeter should be set to its 200 VDC range. The display reading must now be multiplied by 100. If you do not know the voltage to be expected, start with the 1000 VDC range.

CAUTION: Do not exceed the voltage rating of the probe.

RF Probe

You can also use an RF probe with this Multimeter. It should be connected between V/ Ω and COM sockets. Consult the manufacturer's suggestion for which VDC range provides the best accuracy; then set the Multimeter to that range.

CAUTION: Do not exceed the voltage rating of the probe.

FUSE REPLACEMENT

The Multimeter is protected in the mA DC and mA AC modes by the mA fuse which is installed in the fuseholder. Replace it only with a 2A, 250 V, 8AG regular blow fuse. Use of a higher current-rated fuse may cause Multimeter damage.

Measurements

This section deals first with general, then with specific measurement techniques. In addition, it contains some application information to help you obtain valid measurements in harsh environments.

Included are:

- Interpreting the Display
- Connecting the Multimeter
- VDC Measurements
- VAC Measurements
- mA DC Measurements
- mA AC Measurements
- Ω Measurements

INTERPRETING THE DISPLAY

On all ranges of all functions, the measurement display is direct-reading. Correct positioning of the decimal point is automatic.

For voltage measurements, the display reading is in millivolts or volts. On VDC negative polarity is indicated when the “-” sign is displayed. Positive polarity is indicated when the “-” sign is absent (“+” sign is implied). On VAC, no sign is displayed, except during recovery from extreme overloads.

For current measurements, the display reading is in mA. On mA DC negative polarity is indicated when the “-” is displayed. Positive polarity is indicated when the “-” sign is absent (“+” sign is implied). On mA AC, no sign is displayed, except during recovery from extreme overloads.

For resistance readings, the display reading is in Ω , $k\Omega$, or $M\Omega$. No polarity sign is displayed for these measurements, except possibly when the Multimeter is connected to an energized circuit.

CONNECTING THE MULTIMETER

Before you make any measurements with the Multimeter, be sure (if possible) that the measurement will not exceed the limits indicated in the voltage, current, or resistance sections which follow.

Never use uninsulated, cracked, or frayed test leads. Replace or repair any questionable test leads.

All inputs to the Multimeter are made at the three front panel banana jacks identified as V/ Ω , mA, and COM. These will accommodate separate banana plugs or a “dual” banana plug (3/4” centers). You may use the test leads supplied with the Multimeter, or you may make up your own test leads. For low-level VDC or VAC measurements, you may find that using “twisted pair” test leads or coaxial, shielded, cable provides more stable, accurate, measurements. For high current or low resistance measurements, use good quality, stranded, copper wire.

VDC MEASUREMENTS

WARNING: For any VDC measurement, do not connect the COM socket (black test lead) to a voltage that exceeds 500 volts (DC plus peak AC) or 350 volts rms above earth (power line) ground. This can present a safety hazard, or damage the Multimeter when used with the battery eliminator.

CAUTION: 1000 volts (DC plus peak AC) is the maximum voltage allowable between the V/ Ω and COM sockets.

1. Select the operating power for the Multimeter (line or battery). Connect the connector/charger to an AC outlet and the converter/charger's plug to the Multimeter if you selected line operation.
2. Release pushbuttons SW1 and SW8.
3. Depress the pushbutton (SW3 through SW7) that selects the desired range. If you are not sure, select the highest range.

4. Connect the test leads to the Multimeter V/ Ω and COM sockets.
5. Connect the black test lead to circuit ground or the “-” point.
6. Touch the red test lead probe tip to the measurement point and observe the display.
7. Select a higher range if an overload is indicated. For readings less than 200 counts, you may select a lower range for increased resolution.

The following table indicates the display limits for each VDC range:

VDC Range	Minimum Display	Maximum Display
± 200 mV	00.0	199.9
± 2	.000	1.999
± 20	0.00	19.99
± 200	00.0	199.9
± 1000	000	1000

NOTE: Inputs of up to ± 1000 VDC to any range, including the 200 mV DC range, will not damage the Multimeter.

Additional considerations:

- A. To determine measurement accuracy, keep in mind that the accuracy specification for VDC is $\pm (.25\%$ of reading + 1 digit). For example, a display reading of 1.000 VDC from a low impedance source will have an uncertainty of $\pm .0035$ VDC.
- B. The input resistance of the Multimeter on all VDC ranges is 10 M Ω . Measurements at relatively high source resistances could cause a significant reading error. The amount of error due to Multimeter loading can be determined by the following:

$$\% \text{ Error} = - \left(\frac{R_s}{R_s + 10 \text{ M}\Omega} \right) \times 100$$

For example, a source resistance (R_s) of 10 k Ω will result in a loading error of -0.1% . The error will always have a “-” sign, since the loading will always reduce the voltage under “load” from its “unloaded” value.

NOTE: Loading error will become very significant for source resistances above 100 k Ω .

- C. When the Multimeter inputs are open-circuited on the 200 mV DC range, several counts will be displayed due to bias currents in the measuring circuitry. This is normal and will not produce a measurement error when the leads are connected to a low resistance (less than 1 M Ω) source.

VAC MEASUREMENTS

WARNING: For any VAC measurement, do not connect the COM socket (black test lead) to a voltage that exceeds 500 volts (DC plus peak AC) or 350 volts rms above earth (power line) ground. This can present a safety hazard or damage the Multimeter when used with the battery eliminator.

CAUTION: 750 volts AC rms (1000 volts peak AC plus DC) is the maximum voltage allowable between the V/ Ω and COM sockets.

NOTES:

- A. When you measure AC voltage, any input other than a pure sine wave will cause an error because the AC converter is average-sensing and rms (sine wave) calibrated. Square waves, sawtooth waves, etc. can be measured best with an oscilloscope.
- B. After you have first selected the VAC function, allow the Multimeter several seconds to stabilize before you make any measurements. This also applies after a severe overload has occurred.

- C. On VAC ranges, the input signal is AC coupled (capacitive) to the measurement circuitry so that DC is blocked.
- D. The Multimeter will display the measured voltage within rated accuracy within a few seconds, but it may take a few additional seconds to obtain a stable (± 1 count) display.

1. Select the operating power for the Multimeter (line or battery). If you selected line operation, connect the converter/charger to an AC outlet and the converter/charger's plug to the Multimeter.
2. Depress pushbutton SW1.
3. Release pushbutton SW8.
4. Depress the pushbutton (SW3 through SW7) that selects the desired range.
5. Connect test leads to the Multimeter V/ Ω and COM sockets.
6. Connect the black test lead to circuit ground or low point.
7. Touch the red test lead probe tip to the measurement point and observe the display.
8. Select a higher range if an overload is indicated. For readings less than 200 counts, you may select a lower range for increased resolution.

The following table indicates the display limits for each VAC range.

VAC Range	Minimum Display	Maximum Display
200 mV	00.0	199.9
2	.000	1.999
20	0.00	19.99
200	00.0	199.9
750	000	750

NOTE: Applying 750 VAC or less to any range, except the 200 mV AC range, will not damage the Multimeter. An overload that does not exceed 300 VAC (rms) can be applied to the 200 mV AC range indefinitely, and for a maximum of 15 seconds when over 300 VAC.

- A. To determine measurement accuracy, keep in mind that the combined accuracy specification for VAC is \pm (1.5% of reading + 3 digits) over the frequency range applicable to the VAC range being used. For example, a display reading of 1.000 VAC from a low impedance source will have an uncertainty of \pm .018 VAC over the frequency range of 40 Hz to 1000 Hz.

- B. The input impedance of the Multimeter on all VAC ranges is frequency dependent, and can be represented as 10 M Ω in parallel with approximately 100 pF. This corresponds to approximately 9.36 M Ω at 60 Hz. Measurements at relatively high source resistances could cause a significant reading error. The Multimeter input impedance at other frequencies may be determined by the following expression:

$$Z_{IN} = \frac{10 \text{ M}\Omega}{\sqrt{1 + (6.28 \times f)^2}}$$

where Z_{IN} = effective Multimeter input impedance, and

f = frequency in kHz.

Source loading error can be determined as follows:

$$\% \text{ Error} = - \left(\frac{Z_{source}}{Z_{source} + Z_{in}} \right) \times 100$$

Loading error at low frequencies (<100 Hz) can be very significant for source impedance (resistances) above 100 k Ω ; and at higher frequencies (in the order of 1 kHz) for source impedance even as low as 20 k Ω . The error will always have a " - " sign, since the loading will always reduce the voltage under load from its unloaded value.

- C. When the Multimeter inputs are open-circuited on the 200 mV AC or 2 VAC ranges, there will be a significant amount of counts displayed, due to stray line voltage radiation. This is normal and will not produce a measurement error when the leads are connected to a low impedance source.

mA DC MEASUREMENTS

WARNINGS:

- A. For any mA DC measurement, do not connect the COM socket (black test lead) to a voltage exceeding 500 volts (DC plus peak AC) or 350 volts rms above earth (power line) ground. This can present a safety hazard or damage the Multimeter when used with a battery eliminator.
- B. Operator injury or instrument damage may result if the fuse opens while measuring current in a circuit with an open-circuit voltage greater than 250 V.

CAUTION: The Multimeter is fuse-protected for a 2-ampere maximum DC current on the mA DC ranges. If this is exceeded, the fuse will open, the display will read zero, and the circuit under test will be opened. (See "Fuse Replacement" on Page 53).

1. Select the operating power for the Multimeter (line or battery). If you selected line operation, connect the converter/charger to an AC outlet and the converter/charger plug to the Multimeter.
2. Release pushbuttons SW1 and SW8.

3. Depress the pushbutton (SW3 through SW6) that selects the desired range. If you are not sure, select the highest range.
4. Connect test leads to the Multimeter mA and COM sockets.
5. Connect the test leads into the circuit under test, and observe the display.
6. Select a higher range if an overload is indicated. For readings less than 200 counts, you may select a lower range for increased resolution.

The following table indicates the display limits for each mA DC range:

mA DC Range	Minimum Display	Maximum Display
± 2	.000	1.999
± 20	0.00	19.99
± 200	00.0	199.9
± 2000	000	1999

NOTE: Inputs of up to ± 2000 mA DC to any range, will not damage the Multimeter.



Additional Considerations:

- A. To determine measurement accuracy, keep in mind that the accuracy specification for mA DC is $\pm (.75\% \text{ of reading} + 1 \text{ digit})$. For example, a display reading of 1.000 mA DC will have an uncertainty of $\pm .0085 \text{ mA DC}$.
- B. When you measure current, your Multimeter will, to some degree, affect the operation of the circuit you are testing. This effect, known as "insertion loss," causes a voltage drop. This will reduce the actual circuit current to the current displayed on the Multimeter. This error should be considered if the source resistance of the circuit under test is not at least 1000 times the shunt resistor for the range being used. For example, on the 2 mA DC range, the shunt resistor is 100 Ω ; therefore, a source resistance of 10 k Ω would result in an insertion loss error of approximately 1% of the reading. You can determine insertion loss error for other source resistances with the following formula:

$$\% \text{ Error} = - \left(\frac{R_{shunt} + .25 \Omega^*}{R_{source} + R_{shunt} + .25 \Omega^*} \right) \times 100$$

Where R_{shunt}	= 100 Ω	on the 2 mA DC range
	10 Ω	on the 20 mA DC range
	1 Ω	on the 200 mA DC range
	.1 Ω	on the 2000 mA DC range

* .25 Ω is the maximum fuse and wiring resistance of the Multimeter.

The error will always have a " - " sign, since the "inserted" current will always be less than the "not inserted" current. To reduce this effect, use the highest range possible consistent with the measurement resolution required.

- C. When you attempt to measure DC current with a substantial AC or pulse component superimposed on it, no significant error will result if the peak-to-peak variation in current does not exceed three times the full-scale DC current of the range being used (2.0 amperes peak AC plus DC on 2000 mA DC range). A higher range, will minimize this error.

mA AC MEASUREMENTS

WARNINGS:

- A. For any mA AC measurement, do not connect the COM socket (black test lead) to a voltage exceeding 500 volts (DC plus peak AC) or 350 volts rms above earth (power line) ground. This can present a safety hazard or damage the Multimeter when used with a battery eliminator.
- B. Operator injury or instrument damage may result if the fuse opens while measuring current in a circuit with an open-circuit voltage greater than 250 V.

CAUTION: The Multimeter is fuse-protected for a 2-ampere maximum AC current on the mA AC ranges. If this is exceeded, a fuse will open, the display will read zero, and the circuit under test will be opened. (See "Fuse Replacement" on Page 53).

NOTES:

- A. When you measure AC current, any input other than a pure sine wave, will cause an error because the AC converter is average-sensing and rms (sine wave) calibrated. Square waves, sawtooth waves, etc. can be measured best with an oscilloscope.
 - B. After you have first selected the VAC function, allow the Multimeter several seconds to stabilize before you make any measurements. This also applies after a severe overload has occurred.
 - C. On mA AC ranges, the input signal is AC coupled (capacitively) to the measurement circuitry so that DC is blocked.
 - D. The Multimeter will display the measured current within rated accuracy, within a few seconds, but it may take a few additional seconds to obtain a stable (± 1 count) display.
1. Select the operating power for the Multimeter (line or battery). If you selected line operation, connect the converter/charger to an AC outlet and the converter/charger's plug to the Multimeter.
 2. Depress pushbutton SW1.

3. Release pushbutton SW8.
4. Depress the pushbutton (SW3 through SW8) that selects the desired range.
5. Connect the test leads to the Multimeter mA and COM sockets.
6. Connect the test leads into the circuit under test and observe the display.
7. Select a higher range if an overload is indicated. For readings less than 200 counts, you may select a lower range for increased resolution.

The following table indicates the display limits for each mA AC range:

mA AC Range	Minimum Display	Maximum Display
2	.000	1.999
20	0.00	19.99
200	00.0	199.9
2000	000	1999

NOTE: Inputs of up to 2000 mA AC to any range will not damage the Multimeter.

Additional Considerations.

- A. To determine measurement accuracy, you should keep in mind that the accuracy specification for mA AC is \pm (1.5% of reading + 3 digits) from 40 to 1000 Hz on the 20, 200, and 2000 mA ranges and \pm (1.5% of reading + 3 digits) from 40 to 200 Hz on the 2 mA range. Then, as an example, a display reading of 1.000 mA AC will have an uncertainty of $\pm .018$ mA AC.
- B. When you measure current, your Multimeter will, to some degree, affect the operation of the current you are testing. This effect, known as "insertion loss," causes a voltage drop. This will reduce the actual circuit current to the current displayed on the Multimeter. This error should be considered if the source resistance of the circuit under test is not at least 1000 times the shunt resistor for the range being used. For example, on the 2 mA AC range, the shunt resistor is 100 Ω ; therefore, a source resistance of 10 k Ω would result in an insertion loss error of approximately 1% of the reading. You can determine the insertion loss error for other source resistances with the following formula:

$$\% \text{ Error} = - \left(\frac{R_{shunt} + .25 \Omega^*}{R_{source} \times R_{shunt} \times .25 \Omega^*} \right) \times 100$$

Where R_{shunt}	= 100 Ω	on the 2 mA AC range
	10 Ω	on the 20 mA AC range
	1 Ω	on the 200 mA AC range
	.1 Ω	on the 2000 mA AC range

* .25 Ω is the maximum fuse and wiring resistance of the Multimeter.

The error will always have a " - " sign since the "inserted" current will always be less than the "not inserted" current. To reduce this effect, use the highest range possible consistent with the measurement resolution required.

 Ω MEASUREMENTS

CAUTION: Before you make in-circuit resistance measurements, make sure you disconnect power to the circuit. Also discharge all capacitors.

NOTES:

- A. The resistance of the test leads may affect the accuracy on the 200 Ω range of your Multimeter. To determine this error, first short the test leads together and read the lead resistance. Then subtract the lead resistance (typically .1 to .3 Ω) from the reading for the unknown resistor.
- B. When you make resistance measurements on the two highest ranges, the test leads may pick up stray line-noise, which may result in erratic behavior of the last digit in the display. You can minimize this effect by using one or more of the following methods.
1. Twist the test leads together.
 2. Place the unknown resistor directly across the input jacks.
 3. Operate the Multimeter on the internal battery.
 4. Keep your hands away from the test leads.

- C. If an overrange condition occurs while you make resistance measurements on the two highest ranges, it may take several seconds before the display shows the correct, measured value.
- D. You can make in-circuit resistance measurements by using the 200 Ω , 20 k Ω , and 2000 k Ω ranges, since full-scale measurement voltages on these ranges are not sufficient to forward-bias silicon junctions.

Therefore, you can make resistance measurements without having to remove diodes and transistors from the circuit.

- E. On the 2 k Ω , 200 k Ω , 20 M Ω ranges, the Multimeter produces a measurement voltage that is sufficient to forward-bias silicon junctions. These ranges are useful when you check and match diodes and transistors.

The following table indicates the approximate voltage and current characteristics for each resistance range.

Range	Full Scale Voltage (typical)	Short Circuit Current (typical)	Open Circuit Test Voltage (typical)
20 M Ω ←←	800 mV	.12 μ A	1.2 V
2000 k Ω	200 mV	.35 μ A	.35 V
200 k Ω ←←	800 mV	12 μ A	1.2 V
20 k Ω	200 mV	35 μ A	.35 V
2 k Ω ←←	1 V	.75 mA	2.2 V
200 Ω	75 mV	.40 mA	1.2 V

IN CASE OF DIFFICULTY

NOTE: It is important that you read the entire "General Troubleshooting Information" sections which follow, before you attempt to service your Multimeter.

This section of the Manual is divided into four parts. The first part, titled "General Troubleshooting Information," describes what to do about the difficulties that may occur right after your Multimeter is assembled.

The second section, titled "Troubleshooting Precautions," points out the care that is required when you service the Multimeter to prevent damage to the components.

The third part, titled "Troubleshooting Chart," is provided to assist you in servicing the Multimeter if the "General Troubleshooting Information" fails to clear up the problem, or if difficulties occur after your Multimeter has been in use for some time. The "Troubleshooting Chart" lists a number of possible difficulties that could arise along with several possible solutions to those difficulties. Refer to the "Circuit Board X-Ray Views" on Pages 88 and 89 for the physical location of parts on the circuit boards.

The fourth part, "Circuit Board Cleaning," should be used only as a "last resort" to clean a contaminated main circuit board.

General Troubleshooting Information

CAUTION: Always be sure the foil side of the circuit board is positioned on an insulated surface; otherwise, the Multimeter can be damaged.

1. **Recheck the wiring.** It is often helpful to have a friend check your work. Someone who is not familiar with the unit may notice an error that was consistently overlooked by the builder.
2. **About 90% of the kits that are returned for repair do not function properly due to poor connections and soldering.** Therefore, you can eliminate many troubles by checking all connections to make sure that they are soldered correctly. Reheat the connections, if necessary, but be careful so you do not create any solder bridges.
3. **Check the values of all the parts.** Be sure that the proper part has been installed at each location on the circuit board. Refer to the "Circuit Board X-Ray Views" for the physical location of parts on the circuit board.
4. **Check for bits of solder, wire ends, or other foreign matter which may be lodged in the components on the circuit board.**



5. Check very carefully to be sure there are no solder bridges between different circuit board foils. If you are not sure a solder bridge exists, compare the circuit board foil with the "Circuit Board X-Ray Views" on Pages 88 and 89 in this Manual. Remove any solder bridges by holding a clean, hot soldering iron tip between the two points that are bridged until the excess solder flows down onto the tip.

If you still cannot locate and correct the trouble after you have completed the checks listed above, and if a voltmeter is available, check the voltages in the Multimeter against the Schematic. A review of the "Circuit Description" and Schematic may also help you to locate any difficulties in the kit.

In an extreme case where you are unable to resolve a difficulty, refer to the "Customer Service" information inside the rear cover of the Manual. Your Warranty is located inside the front cover.

Troubleshooting Precautions

- Integrated circuits U3 and U4 are MOS (metal-oxide semiconductor) devices and they can be damaged by static electricity. Therefore, make sure you remove these IC's in the same manner that you installed them. Refer to Pages 38 and 39 for the correct technique.
- Be sure you do not short any adjacent terminals or foils when you make tests or voltage measurements. If a probe or test lead slips for example, and shorts together two adjacent connections, it is very likely to cause damage to one or more IC's, transistors, or diodes.
- Be especially careful when you test any circuit that contains an IC or a transistor. Although these components have almost unlimited life when used properly, they are much more vulnerable to damage from excessive voltage or current than many other parts.
- In several areas of the circuit board, the foil patterns are quite narrow. When you unsolder a part to check or replace it, avoid excessive heat while you remove the part. A suction-type desoldering tool will make removal considerably easier. You may also use the desoldering braid supplied with this kit to remove the solder.

Troubleshooting Charts

These charts list the condition and possible causes of several malfunctions. If a particular part is mentioned (U4 for example) as a possible cause, check that part to see if it was installed correctly. Also check it and the parts

connected to it for poor connections. It is also possible, on rare occasions, for a part to be faulty and require replacement.

PROBLEM	POSSIBLE CAUSE
1. No part of the display lights on any function or range.	A. Dead battery. B. SW9. C. ZD1. D. U4. E. LCD1. F. J4. G. Open wiring to battery.
2. LO BAT is displayed.	A. Low battery voltage. B. Q3. C. R25, R26, or R27. D. U3 or U4.
3. One or more display segments do not light.	A. Interconnection between U4 and LCD1. B. LCD1. C. U4.
4. One or more digits do not light.	A. U4.

PROBLEM	POSSIBLE CAUSE
5. One or more display segments are always lit.	A. U4.
6. Improper decimal point operation.	A. SW2 through SW7. B. U3. C. R18, R19, or R21. D. D7.
7. Negative sign improperly displayed.	A. U4.
8. L or X segments of display are lit (see Schematic).	A. Interconnection between display circuit board and LCD1.
9. Display does not respond to any input changes on the 200 mV DC range.	A. U1 or U4. B. C4, C12, C13, C14, C15, or C16. C. R4, R9, R24, or R35 to R38. D. Open in SW1 to SW8 circuit.
10. Readings are out of tolerance on the 200 mV DC range.	A. DC CAL control (R13) improperly adjusted. B. U1. C. R8, R9, R11, R12. D. Q2.
11. Displayed reading is greater than $\pm .001$ on the 2 VDC range with COM and V/ Ω inputs shorted.	A. Main circuit board is contaminated. See "Circuit Board Cleaning" on Page 70. B. U4. C. C16. D. Q4 or Q5.

PROBLEM	POSSIBLE CAUSE
12. Readings are out of tolerance on any (or all) VDC and VAC ranges except the 200 mV range.	A. RN1 or RN2. B. R2 or R3. C. Q4 or Q5.
13. Readings are out of tolerance on the 200 mV AC range for full-scale values only at 60 Hz.	A. U2. B. D5 or D6. C. C9.
14. Readings are out of tolerance on the 200 mV AC range for low values only at 60 Hz.	A. C7 or C8. B. D8 or D9. C. R23.
15. Readings are out of tolerance on the 200 mV AC range for any value at 60 Hz.	A. AC CAL control (R34) improperly adjusted. B. R29, R32, or R33.
16. Readings are out of tolerance on the 200 mV AC range for low frequencies (less than 60 Hz)	A. C5 through C9 or C16. B. R22.
17. Readings are out of tolerance on the 200 mV AC range for high frequencies.	A. U2. B. R4 or R14. C. C11.

PROBLEM	POSSIBLE CAUSE
18. Frequency response is not flat on higher AC voltage ranges.	A. C2 or C3. B. Shield is not grounded.
19. Readings are out of tolerance on the 200 Ω resistance range only.	A. R5.
20. Readings are out of tolerance on the higher resistance ranges.	A. R5. B. RN1.
21. Readings are out of tolerance on the 2000 k Ω and 20 M Ω resistance ranges only.	A. Main circuit board is contaminated. See "Circuit Board Cleaning" on Page 70. B. RN1. C. C1
22. Readings are unstable on all resistance ranges.	A. RT1.
23. Full-scale voltages on all resistance ranges are not as specified.	A. Q1. B. R6 or R7. C. D3 or D4.
24. Displayed reading remains unchanged regardless of current into the mA input.	A. F1 (or wiring). B. D1 or D2. C. Open in SW3, SW4, or SW5 circuit.

PROBLEM	POSSIBLE CAUSE
25. Readings are out of tolerance on the 200 mA or 2000 mA current ranges.	A. RN2.
26. Readings are out of tolerance on all current ranges.	A. R2 or R3. B. RN2.
27. DC CAL control (R13) is turned to either limit.	A. U1. B. R8, R9, R11, R12, or R13.
28. AC CAL control (R34) is turned to either limit.	A. U2. B. D8 or D9. C. R29, R32, R33, or R34. D. C7.
29. AC REF ADJ control (R16) is turned to either limit.	A. U4. B. D10. C. R15, R16, or R17.

Circuit Board Cleaning

Use the following "last resort" procedure to clean a contaminated main circuit board.

1. Remove the bezel, the liquid crystal display, and the LCD holder from the display circuit board.
2. Use demineralized water and a soft brush to clean the entire circuit board and the pushbutton switch assembly. CAUTION: Avoid getting excessive amounts of water in the switches.
3. Bake at 150°F for 5 hours. CAUTION: Allow the circuit board time to cool down before you reassemble the instrument.

SPECIFICATIONS

NOTE: The accuracy of this Multimeter depends on whether you calibrated it using the built-in references or laboratory standards. specifications are listed for both methods of calibration, where applicable, at 25°C.

DC VOLTAGE

Ranges $\pm 200 \text{ mV}, \pm 2\text{V}, \pm 20\text{V}, \pm 200\text{V}, \pm 1000\text{V}.$

Accuracy Laboratory standards:
 $\pm (.25\% \text{ of reading} + 1 \text{ count}).$

Built-in standards:
 $\pm (.35\% \text{ of reading} + 1 \text{ count}).$

Input Impedance	10 M Ω on all ranges.
Overvoltage Protection	1000 VDC, 750 VAC on all ranges.
NMRR* (line and battery operation)	Greater than 40 dB on all ranges. (@ DC, 50 and 60 Hz AC).
CMRR** (line and battery operation)	Greater than 100 dB on all ranges. (@ DC, 50 and 60 Hz AC).

AC VOLTAGE (Average-responding, rms-calibrated)

Ranges	100 mV, 2 V, 20 V, 200 V, 750 V.
Basic Accuracy (50 and 60 Hz)	Laboratory standards: \pm (.5% of reading + 3 counts). Built-in standards: \pm (.6% of reading + 3 counts).
Frequency Response (@ 25°C \pm 10° C referenced to 60 Hz reading).	200 mV, 2V, 20V, 200 V ranges: \pm (1% of reading), 40 Hz to 1 kHz. 750 V range: \pm (1% of reading), 40 to 450 Hz.

*Normal Mode Rejection Ratio.

**Common Mode Rejection Ratio.



Input Impedance	10 M Ω shunted by approximately 100 pF on all ranges.
Overvoltage Protection	2 V, 20 V, 200 V, 750 V ranges: 1000 VDC, 750 VAC. 200 mV range: 1000 VDC; 15 seconds maximum over 300 VAC.

DIRECT CURRENT

Ranges	± 2 mA, ± 20 mA, ± 200 mA, ± 2000 mA.
Accuracy	\pm (.75% of reading + 1 count) on all DC ranges.
Voltage Drop (maximum)	± 2 mA, ± 20 mA, ± 200 mA ranges: .25 VDC at maximum display. ± 2000 mA range: .7 VDC at maximum display.
Overcurrent Protection	2000 mA maximum on all ranges, protected by fuse and clamp diodes in circuits with open circuit voltage less than 250 volts.



ALTERNATING CURRENT (Average-responding, rms-calibrated)

Ranges	2 mA, 20 mA, 200 mA, 2000 mA.
Accuracy	20 mA, 200 mA, 2000 mA ranges: ± (1.5% of reading + 3 counts), 40 Hz to 1 kHz. 2 mA range: ± (1.5% of reading + 3 counts), 40 to 200 Hz.
Voltage Drop (maximum)	2 mA, 20 mA, 200 mA ranges: .25 VAC at maximum display. 2000 mA range: .7 VAC at maximum display.
Overcurrent Protection	2000 mA maximum on all ranges, protected by fuse and clamp diodes in circuits with open circuit voltage less than 250 volts.

RESISTANCE

Ranges	200 Ω, 2 kΩ, 20 kΩ, 200 kΩ, 2000 kΩ, 20 MΩ.
--------------	---



Accuracy	200 Ω range: \pm (.3% of reading + 3 counts), 2 k Ω , 20 k Ω , 200 k Ω , 2000 k Ω ranges: \pm (.25% of reading + 1 count). 20 M Ω range: \pm (2% of reading + 1 count).
Voltage @ max. display	200 Ω , 20 k Ω , 2000 k Ω ranges (low test voltage): Less than .25 VDC. 2 k Ω , 200 k Ω , 20 M Ω ranges (high test voltage): Greater than .7 VDC.
Overvoltage Protection	300 volts DC or AC on all ranges.

GENERAL

Operating Temperature Range	0°C to 50°C (32°F to 122°F).
Storage Temperature	-20°C to 60°C (-4°F to 140°F).
Temperature Coefficient	\pm (.1 \times applicable accuracy)/°C.
Power Requirements	9-volt battery (NEDA 1604) or Heath PS-2350 or PS-2450 Converter/Charger.

Battery Life (typical)	Alkaline 200 hours; carbon-zinc 100 to 150 hours.
Battery Indicator	Displays "LO BAT" when approximately 20% of battery life remains.
Polarity Indication	Automatic negative, implied positive on VDC, mA DC.
Overrange Indication	All digits except most significant digit blanked.
Maximum Resolution	Voltage: 100 μ V.
(low range)	Current: 1 μ A.
	Resistance: .1 Ω .
Display Rate	Approximately 2-1/2 per second.
Display	3-1/2 digit (1999 maximum count) liquid crystal.
Dimensions	2" H \times 3-1/4" W \times 7-1/2" L (5.1 \times 8.3 \times 19.1 cm)
Weight	14 oz. (400g) with battery.

The Heath Company reserves the right to discontinue products and to change specifications at any time without incurring any obligation to incorporate new features in products previously sold.

CIRCUIT DESCRIPTION

Refer to the Schematic Diagram, the Block Diagram (Illustration Booklet, Page 18), and the following Pictorials as you read this "Circuit Description."

BASIC METER CIRCUIT

The analog-to-digital (A/D) converter, liquid crystal display (LCD), and DC voltage reference make up the basic meter circuit, which provides a digital indication for DC input voltages between -199.9 millivolt and $+199.9$ millivolt. The MOS/LSI integrated circuit (U4) contains all of the active analog, digital, timing, and display drive circuits required for the 3-1/2 digit A/D conversion.

U1 is a temperature-compensated, 1.23 volt DC reference, which is used to establish a reference voltage for the A/D conversion process. U1 also provides a known DC voltage at TP1 for calibration purposes. R8 sets the reverse current through U1 at about 1 mA. Shunt capacitor C4 prevents U1 from oscillating; thus, ensuring reference stability under all operating conditions. R11, R12, and R13 form a resistive voltage divider, which establishes a 100.0 millivolt voltage drop across R11 when R13 is properly adjusted.

The reference voltage across R11 is applied to A/D REF HI and REF LO inputs in the voltage and current modes of operation. This voltage charges reference capacitor C14 once every conversion cycle (once every .4 second). R24 and C14 provide low-pass filtering of the reference voltage, reducing noise effect. When the Multimeter is operated in the resistance mode, the

reference circuit is used as a voltage source for resistance measurements (see "Resistance Measurements").

C15 and R38 are oscillator components which determine the A/D converter's oscillator frequency of approximately 40 kHz. This frequency provides 2-1/2 conversions per second and helps suppress 50 and 60 Hz noise. The entire conversion timing sequence is controlled by this oscillator.

U4 is powered by a 9-volt battery, which is connected across V_{DD} and V_{SS} . An internal regulator on U4 sets V_{DD} (pin 1) at approximately $+2.8$ volts with respect to the COM pin (32). The COM pin is used as analog ground. The TEST pin (37) is about -2.2 volts with respect to COM and is used as the digital ground for U4 and the decimal and annunciator drives circuitry.

IN LO (pin 30) and IN HI (pin 31) are the analog signal inputs to the A/D converter. R35 and C16 provide low-pass filtering of the input signal to suppress AC line and noise signals from the input DC signal. Transistors Q4 and Q5 are connected as clamp diodes to protect U4 against excessive positive or negative input voltages. Under overload conditions, R35 limits the current passing through Q4 and Q5, while R36 limits the current to U4.

C13 is charged by internally generated voltages to compensate for offset voltages in the analog circuitry of U4. This "automatic zeroing" ensures that the digital display will be zero for a zero voltage input to the A/D converter input.



Integrating resistor R37 and integrating capacitor C12 are used in conjunction with the internal circuitry of U4 to integrate the analog input voltage over a fixed time interval. After integration, the voltage across the reference capacitor is used to return the integrator output to zero. The time required for the output to return to zero is proportional to the analog input signal. Specifically,

$$\text{Display reading} = 1000 \left[\frac{V_{IN HI} - V_{IN LO}}{V_{REF HI} - V_{REF LO}} \right]$$

RESISTANCE MEASURING CIRCUIT

Resistance measurements are accomplished with a ratiometric technique which compares the voltage across a standard resistor with the voltage across the resistor being measured. This is possible since the A/D converter produces a display that is proportional to the ratio of the A/D analog input voltage (V_{in}) to the A/D reference input voltage (V_{ref}). Specifically, the

digital value displayed is: $1000 \left(\frac{V_{in}}{V_{ref}} \right)$. Therefore, if V_{in} and V_{ref} are equal, 1000 would be displayed.

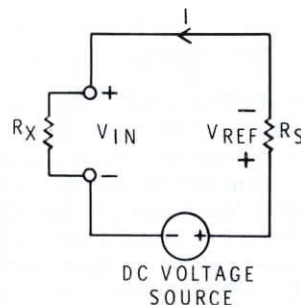

PICTORIAL 7-1

In Pictorial 7-1, the DC voltage source forces a current to pass through unknown resistor R_x and standard resistor R_s . This current produces a voltage drop across each resistor such that:

$$V_{in} = R_x I \quad \text{and} \quad V_{ref} = R_s I.$$

If these equations are substituted for V_{in} and V_{ref} in the previous A/D equation, the displayed value will be:

$$\left(\frac{V_{in}}{V_{ref}} \right) = 1000 \frac{R_x I}{R_s I} = 1000 \frac{R_x}{R_s}$$

Since the value of R_s is chosen to be some power of 10, the displayed value is equal to the unknown resistance times a power of 10 scaling factor.

As shown in Pictorial 7-2, the voltage across unknown resistor R_x is applied to A/D converter inputs IN HI and IN LO through a low-pass filter and protection circuitry. The voltage across standard resistor R_s (RN1 and R5) is applied to A/D converter inputs REF HI and REF LO through a low-pass filter made up of R24 and C14. Transistor Q2 is connected as a zener diode; therefore, its emitter-collector voltage is limited to approximately 9 volts when the "diode" is reverse-biased by a positive overload voltage. When the "diode" is forward-biased by a negative overload voltage, the emitter-collector voltage of Q2 is approximately -0.7 volt. In either case, a current path exists through Q2, RT1, R1, and the source of the overload. RT1 acts as a linear resistor until the current through it exceeds 12 mA. Above this value its resistance increases rapidly in a non-linear manner, limiting the current to some value less than 12 mA. This provides protection for the A/D reference inputs as well as for the DC voltage source.

U1 is used as a DC voltage source for ohms measurements. The exact value of the voltage is not important since the same current passes through both the unknown resistor and the standard resistor for any value. It is this current that establishes the ratiometric voltages. Transistor Q1 is driven into saturation on the 20 k Ω and 2000 k Ω ranges, effectively reducing the DC test voltage at the bottom of the standard resistor string (junction of R5 and R6). On the 200 Ω range, considerable voltage drops across R9, RT1, and R1 provide the desired low test voltage condition.

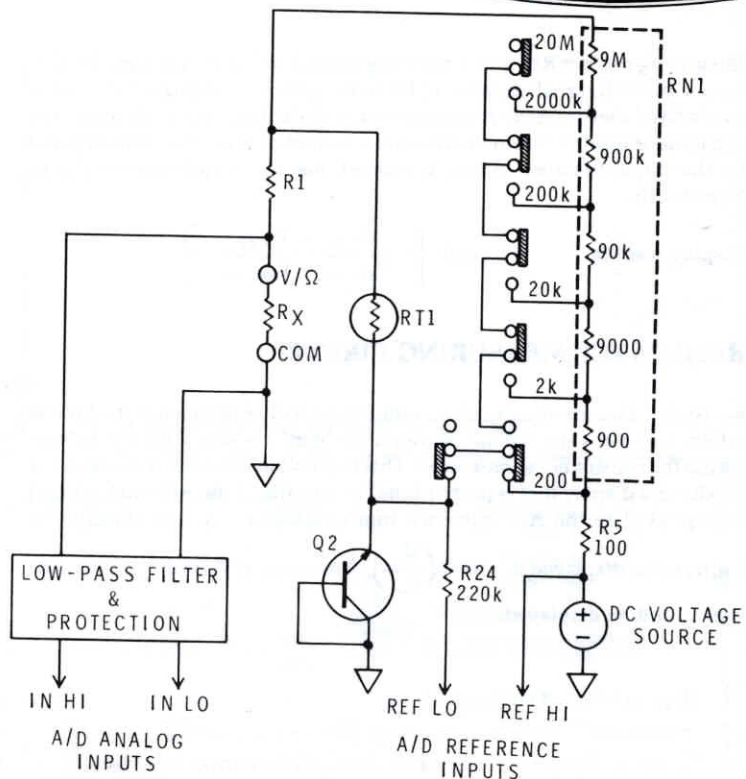

PICTORIAL 7-2

DECIMAL POINT AND ANNUNCIATOR DRIVE

One input of each of the Exclusive OR gates in U3 is connected to the backplane (BP) pin of U4 (see Pictorial 7-3). The other inputs are normally "pulled down" to digital ground by resistors R18, R19, R21, and R26. When these inputs are pulled down, the LO BAT annunciator and the decimal

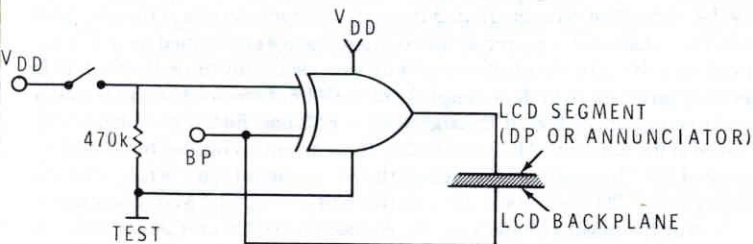

PICTORIAL 7-3

points (DPs) are blanked (off), since the back plane and segment waveforms are in phase and the net voltage from LCD backplane to segment is zero.

When the switch is closed, the gate input is "pulled up" to V_{DD} and the segment waveform is shifted 180° with respect to the backplane waveform. This results in a net LCD drive waveform with a 5 volts rms or 10 volts peak-to-peak value (see Pictorial 7-4).

When the battery voltage ($V_{DD} - V_{SS}$) is higher than approximately 7.2 volts, Q3 is saturated and pin 2 of U3 is pulled near digital ground, so the LO BAT annunciator is blanked. When the battery voltage drops to about 7.2 volts, pin 2 of U3 is pulled to V_{DD} . This turns the annunciator on, at which time approximately 20% of the battery capacity remains before the accuracy of Multimeter falls off.

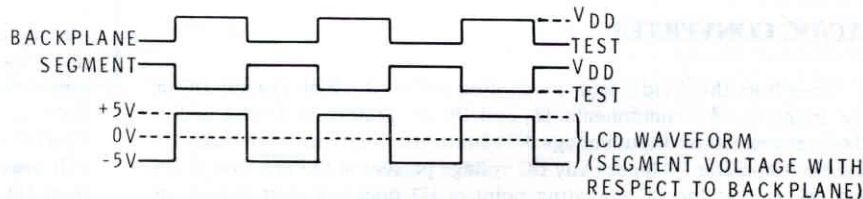

PICTORIAL 7-4

VOLTAGE DIVIDER/STANDARD RESISTORS

RN1, R2, R3, and RN2 form a decade resistive divider network for attenuating input voltages. Range switches select the proper tap in the divider network. On the 200 mV range, the input voltage is applied directly to the AC/DC or A/D converter through R4, which provides current limiting for the AC/DC converter. C2 and C3 are voltage divider compensation capacitors, which extend the AC frequency response of the Multimeter. RN1 and R5 are used as standard resistors for resistance measurements.

CURRENT SHUNTS

R2, R3, and RN2 are used as current shunts for DC and AC current measurements. RN2 provides four-terminal measurement on the 200 and 2000 mA ranges; therefore, errors are reduced due to switch and contact resistances. D1 and D2 are voltage clamps which, together with F1, protect the shunts from voltage and current overloads.

AC/DC CONVERTER

Voltages from the divider taps are applied to C5, which blocks any DC or low frequency AC components. D5 and D6 are protection diodes which clamp any excessive input voltage. R14 limits the peak current through D5 and D6. Capacitor C6 blocks any DC voltage present at the junction of D5 and D6, so that the DC operating point of U2 does not shift during an overload condition. R22 references the very high input resistance of U2 to ground. Due to the high value of R22, it has a very small loading effect on the divider resistance with respect to ground.

The U2 circuitry has two separate feedback paths; one for DC and one for AC. The DC feedback signal, through R23, causes the DC output level at pin 6 of U2 (by virtue of its high gain) to track the DC voltage at pin 3. If the output varies from this point, a correction signal to pin 2 counteracts the variation.

When 200 mV AC is applied to pin 3 of U2, the positive and negative half cycles of the sine wave are routed through different circuits at the output of U2. These half cycles are recombined in a manner as described next. For the positive half cycle, the pin 6 output is driven positive by the gain of U2. This output variation, which is coupled through C8, forward biases D9 and a positive current is forced through R32 to R33 and R34. The voltage produced at the junction of R32 and R33 by this current is coupled by C7 back to pin 2 of U2. The positive half cycle of the AC voltage at pin 2 is forced by the high gain of U2 to be equal to the positive half-cycle of the AC voltage at pin 3. During the negative half cycle, the AC output at C8 biases D8 on and, in a similar manner as just described, the negative half-cycle at R33 is coupled back to pin 2 and is the same as the negative half-cycle at pin 3.

During the positive half-cycle, the peak voltage out of D9 to R32 is divided down by the R32 through R34 circuit. However, since the voltage at R33 must be equal to the peak voltage at pin 3, the peak voltage at R32 is higher. R32 has, in fact, approximately a .63 volt peak value when the input at pin 3 (200 mV AC) has a .28 volt peak value. Likewise, the output of D8 has a -.63 volt peak value. During the positive half-cycle, the positive peak voltage from D9 charges C9 through R31. During the negative half-cycle, C9 is discharged somewhat (through R32) by the -.28 volt peak signal at R33. However, the net charge during a complete cycle results in a positive charge on C9.

Adjustment of the gain of this circuit is made at R34 such that, for example, a 190 mV AC signal applied to the Multimeter on the lowest range produces +190 mV DC at the junction of R31 and C9. This is measured by the A/D circuit.

C11 provides a peaking of the high-frequency response of this circuit by increasing the circuit gain for frequencies above 500 Hz.

INTERNAL REFERENCES

U1 is extremely stable with respect to temperature, bias current variations, and aging. Its reverse breakdown voltage has been measured accurately and then recorded for use as a "reference" voltage for DC calibration.

The backplane signal of U4 is a high quality, 50 Hz square wave which can be used for calibrating the AC/DC converter. A known ratio exists between the values displayed for AC and DC mode measurements of the voltage at TP2. D10 rectifies the backplane signal. R15, R16 and R17 form a voltage divider. In the DC mode, R16 is adjusted for a voltage of 171.2 mV at TP2. The AC mode is then selected and R34 is adjusted for a reading of 190.0 mV.

SEMICONDUCTOR IDENTIFICATION CHARTS

DIODES

CIRCUIT COMPONENT NUMBER	HEATH PART NUMBER	MAY BE REPLACED WITH	IDENTIFICATION
D3, D4, D7 D8, D9, D10	56-56	1N4149	<div data-bbox="868 464 1392 743" style="border: 1px solid black; padding: 10px;"> <p data-bbox="948 479 1314 519">IMPORTANT: THE BANDED END OF DIODES CAN BE MARKED IN A NUMBER OF WAYS.</p>  <p data-bbox="1030 710 1125 726">BANDED END</p> </div>
ZD1	56-90	1N4742A	
D5, D6	56-652	1N4448	
D1, D2	57-613	selected 1N5624	

DISPLAY

CIRCUIT COMPONENT NUMBER	HEATH PART NUMBER	MAY BE REPLACED WITH	IDENTIFICATION
LCD1	411-843	AND FE0203 or BECKMAN 739-02050 or HAMLIN 3933-363-159	<p>The diagram illustrates the LCD1 display assembly. It features a central display area with three digit positions labeled DP3, DP2, and DP1. Each digit position has three segments labeled A, B, and C. Above the digits are three indicator lamps labeled A1, A2, and A3. To the left of the digits are two indicator lamps labeled X and Y. A 'LO BAT' indicator is also present. The assembly is connected to a 40-pin connector at the top and a 20-pin connector at the bottom. The pin connections are as follows:</p> <p>40-pin connector (top):</p> <ul style="list-style-type: none"> Pin 1: B Pin 2: P Pin 3: X Pin 4: I Pin 5: B Pin 6: (blank) Pin 7: (blank) Pin 8: (blank) Pin 9: (blank) Pin 10: (blank) Pin 11: (blank) Pin 12: (blank) Pin 13: (blank) Pin 14: (blank) Pin 15: (blank) Pin 16: (blank) Pin 17: (blank) Pin 18: (blank) Pin 19: (blank) Pin 20: (blank) Pin 21: (blank) Pin 22: (blank) Pin 23: (blank) Pin 24: (blank) Pin 25: (blank) Pin 26: (blank) Pin 27: (blank) Pin 28: (blank) Pin 29: (blank) Pin 30: (blank) Pin 31: (blank) Pin 32: (blank) Pin 33: (blank) Pin 34: (blank) Pin 35: (blank) Pin 36: (blank) Pin 37: (blank) Pin 38: (blank) Pin 39: (blank) Pin 40: (blank) <p>20-pin connector (bottom):</p> <ul style="list-style-type: none"> Pin 1: B Pin 2: P Pin 3: Y Pin 4: K Pin 5: (blank) Pin 6: (blank) Pin 7: (blank) Pin 8: (blank) Pin 9: (blank) Pin 10: (blank) Pin 11: (blank) Pin 12: (blank) Pin 13: (blank) Pin 14: (blank) Pin 15: (blank) Pin 16: (blank) Pin 17: (blank) Pin 18: (blank) Pin 19: (blank) Pin 20: (blank)

TRANSISTORS

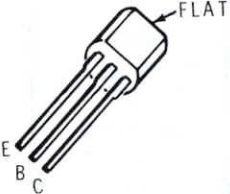

CIRCUIT COMPONENT NUMBER	HEATH PART NUMBER	MAY BE REPLACED WITH	IDENTIFICATION
Q2	417-864	MPSA05	
Q1, Q3 Q4, Q5	417-875	2N3904	

INTEGRATED CIRCUITS

CIRCUIT COMPONENT NUMBER	HEATH PART NUMBER	MAY BE REPLACED WITH	IDENTIFICATION (TOP VIEW)																																																																																
U4	442-678	ICL7106CPL	<table border="0"> <tr> <td>(+) SUPPLY</td> <td>1</td> <td>40</td> <td>OSC. 1</td> </tr> <tr> <td>D (UNITS)</td> <td>2</td> <td>39</td> <td>OSC. 2</td> </tr> <tr> <td>C (UNITS)</td> <td>3</td> <td>38</td> <td>OSC. 3</td> </tr> <tr> <td>B (UNITS)</td> <td>4</td> <td>37</td> <td>TEST</td> </tr> <tr> <td>A (UNITS)</td> <td>5</td> <td>36</td> <td>REF HI</td> </tr> <tr> <td>F (UNITS)</td> <td>6</td> <td>35</td> <td>REF LO</td> </tr> <tr> <td>G (UNITS)</td> <td>7</td> <td>34</td> <td>REF. CAP</td> </tr> <tr> <td>E (UNITS)</td> <td>8</td> <td>33</td> <td>REF. CAP</td> </tr> <tr> <td>D (TENS)</td> <td>9</td> <td>32</td> <td>COMMON</td> </tr> <tr> <td>C (TENS)</td> <td>10</td> <td>31</td> <td>INPUT HI</td> </tr> <tr> <td>B (TENS)</td> <td>11</td> <td>30</td> <td>INPUT LO</td> </tr> <tr> <td>A (TENS)</td> <td>12</td> <td>29</td> <td>AUTO-ZERO</td> </tr> <tr> <td>F (TENS)</td> <td>13</td> <td>28</td> <td>BUFFER</td> </tr> <tr> <td>E (TENS)</td> <td>14</td> <td>27</td> <td>INTEGRATOR</td> </tr> <tr> <td>D (100's)</td> <td>15</td> <td>26</td> <td>(-) SUPPLY</td> </tr> <tr> <td>B (100's)</td> <td>16</td> <td>25</td> <td>G (TENS)</td> </tr> <tr> <td>F (100's)</td> <td>17</td> <td>24</td> <td>C (100's)</td> </tr> <tr> <td>E (100's)</td> <td>18</td> <td>23</td> <td>A (100's)</td> </tr> <tr> <td>BC (1000)</td> <td>19</td> <td>22</td> <td>G (100's)</td> </tr> <tr> <td>POLARITY (MINUS)</td> <td>20</td> <td>21</td> <td>BACKPLANE</td> </tr> </table>	(+) SUPPLY	1	40	OSC. 1	D (UNITS)	2	39	OSC. 2	C (UNITS)	3	38	OSC. 3	B (UNITS)	4	37	TEST	A (UNITS)	5	36	REF HI	F (UNITS)	6	35	REF LO	G (UNITS)	7	34	REF. CAP	E (UNITS)	8	33	REF. CAP	D (TENS)	9	32	COMMON	C (TENS)	10	31	INPUT HI	B (TENS)	11	30	INPUT LO	A (TENS)	12	29	AUTO-ZERO	F (TENS)	13	28	BUFFER	E (TENS)	14	27	INTEGRATOR	D (100's)	15	26	(-) SUPPLY	B (100's)	16	25	G (TENS)	F (100's)	17	24	C (100's)	E (100's)	18	23	A (100's)	BC (1000)	19	22	G (100's)	POLARITY (MINUS)	20	21	BACKPLANE
(+) SUPPLY	1	40	OSC. 1																																																																																
D (UNITS)	2	39	OSC. 2																																																																																
C (UNITS)	3	38	OSC. 3																																																																																
B (UNITS)	4	37	TEST																																																																																
A (UNITS)	5	36	REF HI																																																																																
F (UNITS)	6	35	REF LO																																																																																
G (UNITS)	7	34	REF. CAP																																																																																
E (UNITS)	8	33	REF. CAP																																																																																
D (TENS)	9	32	COMMON																																																																																
C (TENS)	10	31	INPUT HI																																																																																
B (TENS)	11	30	INPUT LO																																																																																
A (TENS)	12	29	AUTO-ZERO																																																																																
F (TENS)	13	28	BUFFER																																																																																
E (TENS)	14	27	INTEGRATOR																																																																																
D (100's)	15	26	(-) SUPPLY																																																																																
B (100's)	16	25	G (TENS)																																																																																
F (100's)	17	24	C (100's)																																																																																
E (100's)	18	23	A (100's)																																																																																
BC (1000)	19	22	G (100's)																																																																																
POLARITY (MINUS)	20	21	BACKPLANE																																																																																

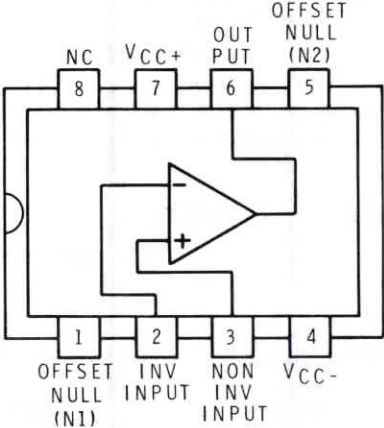
Integrated Circuits (cont'd.)

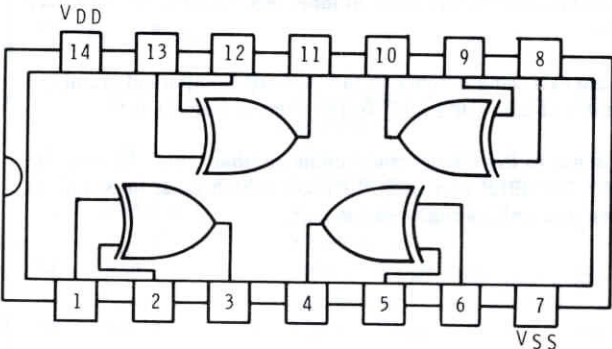
CIRCUIT COMPONENT NUMBER	HEATH PART NUMBER	MAY BE REPLACED WITH	IDENTIFICATION
U2	442-679	TL061CP	

CIRCUIT COMPONENT NUMBER	HEATH PART NUMBER	MAY BE REPLACED WITH	IDENTIFICATION
U3	443-917	CD4030AE	
U1	SELECTED (PART OF 100-1757)		

CIRCUIT BOARD X-RAY VIEWS

NOTE: To find the PART NUMBER of a component for the purpose of ordering a replacement part:

- A. Find the circuit component number (R5, C3, etc.) on the X-Ray View.
- B. Locate this same number in the "Circuit Component Number" column of the "Parts List" in the front of this Manual.
- C. Adjacent to the circuit component number, you will find the PART NUMBER and DESCRIPTION which must be supplied when you order a replacement part.

DISPLAY CIRCUIT BOARD

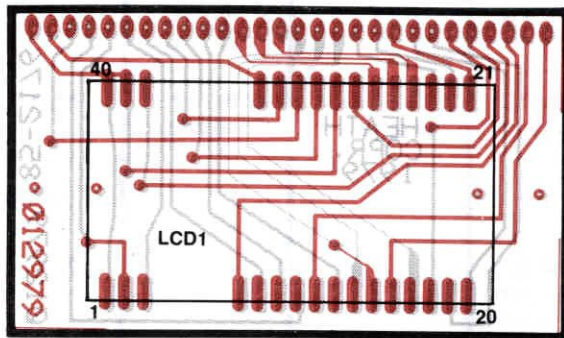

(Viewed from the component side)

MAIN CIRCUIT BOARD

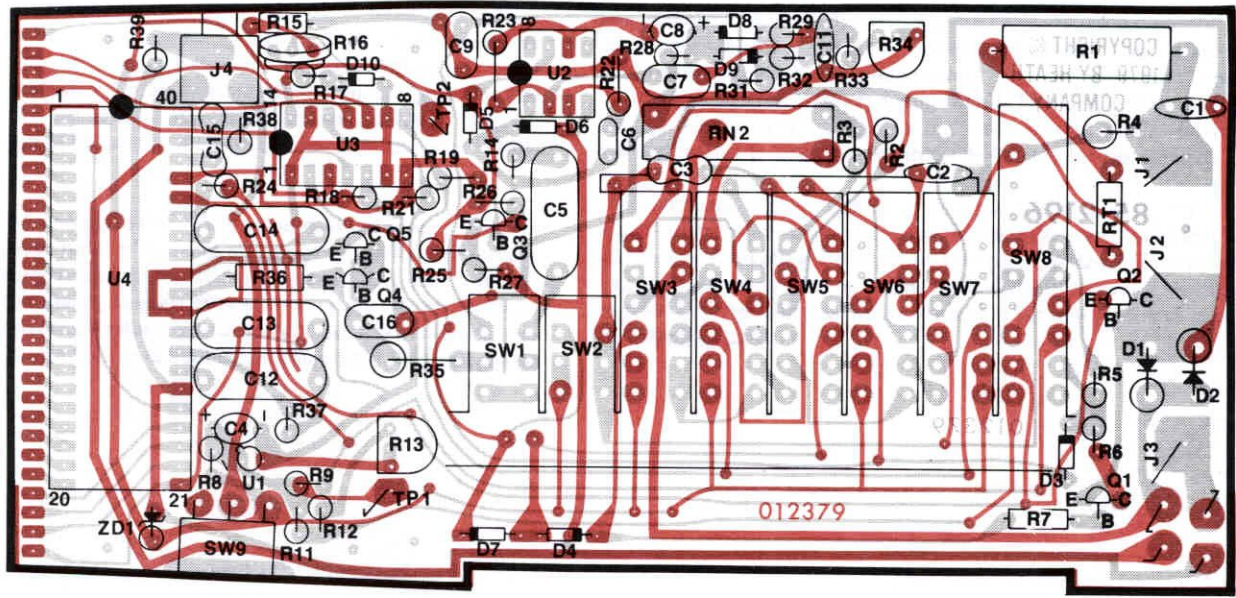

(Viewed from the component side)

1. The first part of the report

is devoted to a description of the

general situation in the

country at the beginning of the

year. It is followed by a

description of the work done

during the year and a

summary of the results.

The second part of the report

is devoted to a description of the

work done during the year.

It is followed by a summary of the

results.

The third part of the report

is devoted to a description of the

work done during the year.

It is followed by a summary of the

results.

The fourth part of the report

is devoted to a description of the

work done during the year.

It is followed by a summary of the

results.

The fifth part of the report

is devoted to a description of the

work done during the year.

It is followed by a summary of the

results.

The sixth part of the report

is devoted to a description of the

work done during the year.

It is followed by a summary of the

results.

The seventh part of the report

is devoted to a description of the

work done during the year.

It is followed by a summary of the

results.

FOR PARTS REQUESTS ONLY

- Be sure to follow instructions carefully.
- Use a separate letter for all correspondence.
- Please allow 10 - 14 days for mail delivery time.

SEND TO:

DO NOT WRITE IN THIS SPACE

HEATH COMPANY
 BENTON HARBOR
 MICHIGAN 49022
ATTN: PARTS REPLACEMENT
 Phone (Replacement parts only):
 616 982-3571

INSTRUCTIONS

- Please print all information requested.
- Be sure you list the correct **HEATH** part number exactly as it appears in the parts list.
- If you wish to prepay your order, mail this card and your payment in an envelope. Be sure to include 10% (25¢ minimum, \$3.50 maximum) for insurance, shipping and handling. Michigan residents add 4% tax.

Total enclosed \$ _____

- If you prefer COD shipment, check the COD box and mail this card. COD

NAME _____

ADDRESS _____

CITY _____

STATE _____ ZIP _____

The information requested in the next two lines is not required when purchasing nonwarranty replacement parts, but it can help us provide you with better products in the future.

Model # _____ Invoice # _____

Date Purchased _____ Location Purchased _____

LIST HEATH
PART NUMBER

QTY.

PRICE
EACHTOTAL
PRICE

TOTAL FOR PARTS _____

HANDLING AND SHIPPING _____

MICHIGAN RESIDENTS ADD 4% TAX _____

TOTAL AMOUNT OF ORDER _____



HEATH COMPANY • BENTON HARBOR, MICHIGAN 49022
TLX 72-9421

IMPORTANT NOTICE

Please make the following change in your Manual before you begin to assemble your kit.

Page 39 — Right column. Add the following Note between the first and second step.

NOTE: Locate the shield and peel the silver coating from its outer edge, if it has not already been removed. Be sure to remove the coating all the way around the shield.

Thank you,

HEATH COMPANY

IM-2215/595-2233-02
591-3141

CUSTOMER SERVICE

REPLACEMENT PARTS

Please provide complete information when you request replacements from either the factory or Heath Electronic Centers. Be certain to include the **HEATH** part number exactly as it appears in the parts list.

Replacement parts are maintained specifically to repair Heath products. Parts sales for other reasons will be declined.

ORDERING FROM THE FACTORY

Print all of the information requested on the parts order form furnished with this product and mail it to Heath. For telephone orders (parts only) dial 616 982-3571. If you are unable to locate an order form, write us a letter or card including:

- Heath part number.
- Model number.
- Date of purchase.
- Location purchased or invoice number.
- Nature of the defect.
- Your payment or authorization for COD shipment of parts not covered by warranty.

Mail letters to: Heath Company
Benton Harbor
MI 49022
Attn: Parts Replacement

Retain original parts until you receive replacements. Parts that should be returned to the factory will be listed on your packing slip.

OBTAINING REPLACEMENTS FROM HEATH ELECTRONIC CENTERS

For your convenience, "over the counter" replacement parts are available from the Heath Electronic Centers listed in your catalog. Be sure to bring in the original part and purchase invoice when you request a warranty replacement from a Heath Electronic Center.

TECHNICAL CONSULTATION

Need help with your kit? — Self-Service? — Construction? — Operation? — Call or write for assistance. You'll find our Technical Consultants eager to help with just about any technical problem except "customizing" for unique applications.

The effectiveness of our consultation service depends on the information you furnish. Be sure to tell us:

- The Model number and Series number from the blue and white label.
- The date of purchase.
- An exact description of the difficulty.
- Everything you have done in attempting to correct the problem.

Also include switch positions, connections to other units, operating procedures, voltage readings, and any other information you think might be helpful.

Please do not send parts for testing, unless this is specifically requested by our Consultants.

Hints: Telephone traffic is lightest at midweek — please be sure your Manual and notes are on hand when you call.

Heathkit Electronic Center facilities are also available for telephone or "walk-in" personal assistance.

REPAIR SERVICE

Service facilities are available, if they are needed, to repair your completed kit. (Kits that have been modified, soldered with paste flux or acid core solder, cannot be accepted for repair.)

If it is convenient, personally deliver your kit to a Heathkit Electronic Center. For warranty parts replacement, supply a copy of the invoice or sales slip.

If you prefer to ship your kit to the factory, attach a letter containing the following information directly to the unit:

- Your name and address.
- Date of purchase and invoice number.
- Copies of all correspondence relevant to the service of the kit.
- A brief description of the difficulty.
- Authorization to return your kit COD for the service and shipping charges. (This will reduce the possibility of delay.)

Check the equipment to see that all screws and parts are secured. (Do not include any wooden cabinets or color television picture tubes, as these are easily damaged in shipment. Do not include the kit Manual.) Place the equipment in a strong carton with at least THREE INCHES of resilient packing material (shredded paper, excelsior, etc.) on all sides. Use additional packing material where there are protrusions (control sticks, large knobs, etc.). If the unit weighs over 15 lbs., place this carton in another one with 3/4" of packing material between the two.

Seal the carton with reinforced gummed tape, tie it with a strong cord, and mark it "Fragile" on at least two sides. Remember, the carrier will not accept liability for shipping damage if the unit is insufficiently packed. Ship by prepaid express, United Parcel Service, or insured Parcel Post to:

Heath Company
Service Department
Benton Harbor, Michigan 49022



HEATH COMPANY • BENTON HARBOR, MICHIGAN
THE WORLD'S FINEST ELECTRONIC EQUIPMENT IN KIT FORM

LITHO IN U.S.A.