

ASSEMBLING
AND USING
YOUR

Heathkit

OSCILLOSCOPE
MODEL O-9

595-74

HEATH COMPANY

BENTON HARBOR,
MICHIGAN

PRICE \$1.00

THE WORLD'S *Finest* TEST EQUIPMENT IN KIT FORM

ASSEMBLY AND OPERATION OF THE HEATHKIT OSCILLOSCOPE

MODEL O-9



SPECIFICATIONS

Vertical: Frequency Response.....	±2 db 10 cycles to 2 mc
	±6 db 5 cycles to 3 mc
Sensitivity.....	0.025 volts per inch at 1 kc
Input Impedance.....	47 $\mu\mu\text{f}$ shunting 2 megohm X1 position
	35 $\mu\mu\text{f}$ shunting 2 megohm X10-100 position
Horizontal: Frequency Response.....	±6 db 10 cycles to 500 kc
Sensitivity.....	0.6 volts per inch at 1 kc
Input Impedance.....	25 $\mu\mu\text{f}$ shunting 1 megohm
Sweep Generator.....	Multivibrator - frequency range of 10-50,000 cps
Tube Complement.....	1 - 5UP1 Cathode Ray Tube
	1 - 6AB4 Vertical Input
	1 - 12AU7 Horizontal Input and Blanking
	1 - OD3 Regulator
	1 - 6C4 Vertical Phase Splitter
	4 - 12AT7 Multivibrator, Vertical Cascade Amplifier, Horizontal and Vertical Deflection Amplifiers.
	2 - 5Y3GT Low and High Voltage Rectifiers
Power Requirements.....	105-125 volts 50/60 cycle, 70 watts
Dimensions.....	8 5/8" wide x 14 1/8" high x 16" deep
Net Weight.....	18 1/2 lbs.
Shipping Weight.....	26 lbs.

INTRODUCTION

The cathode ray oscilloscope has been described as the most versatile indicating device available today. It has earned this reputation because of its ability to display, in usable form, the relationships between any two electrical quantities, or between an electrical quantity and time. The oscilloscope can be used to evaluate changes in voltage, current, phase, frequency and wave form as referred to a time base. With the unlimited number of transducers available to the engineer today, it is a simple matter to convert almost any other physical quantity into an electrical variation which can then be displayed on the screen of the oscilloscope.

The advantages of the oscilloscope as a measuring device are based on the following characteristics:

1. It is a rugged instrument which cannot be damaged by overload or surges.
2. Its indicating medium has no apparent inertia and can therefore respond to variations at rates far beyond the scope of other instruments.
3. It reflects almost no load on the circuit under investigation.
4. Its sensitivity can be varied over extreme ranges.
5. When necessary, a permanent photographic record of its display can be obtained so that none of its advantages are lost in the recording process.
6. It is economical in cost, in maintenance, and in time required from the user.

BASIC PRINCIPLES OF OPERATION

The cathode ray tube consists of an electron gun, which shoots a stream of electrons toward the fluorescent screen. The screen lights up where the electrons hit. The amount of electrons that hit the screen, and therefore the brightness of the spot, is controlled by the intensity control. The size of the spot is controlled by the focus control.

After leaving the electron gun, the electron stream passes between two sets of parallel deflecting plates which are set at right angles. The electron stream can be attracted to or repelled by these deflecting plates, by placing a positive or negative charge on these plates. Such charges or voltages bend the beam and thus move the position of the spot on the screen.

About 50 volts potential difference between a pair of plates is required to deflect the spot one inch. Therefore, amplifiers must be used in an oscilloscope of small voltages are to be observed clearly. Gain controls in the amplifier circuits permit adjustment of the size of the pattern on the screen.

The centering controls vary the normal (no signal) deflecting plate voltages and thus permit the undeflected spot to be centered on the screen.

The sweep generator produces a sawtooth type of voltage. When applied to the horizontal deflecting circuit, this voltage will cause the spot to move at a steady rate across the screen. At the end of its travel, the spot will rapidly return to its starting point, only to begin moving again at a steady rate. This steady movement is called the trace, and the rapid return is known as retrace.

If, in addition to the sweep signal in the horizontal amplifier, a signal is applied to the vertical amplifier, the spot will not only move left and right, but also up and down. Therefore the spot will trace the shape of the amplitude of the vertical signal with respect to time, which is the customary way to display such signals.

Frequently other horizontal signal sources are used. These are then connected to the horizontal amplifier in place of the internal sweep generator.

This completes the actual construction and wiring of the oscilloscope.

Before attempting to operate the instrument, recheck each step in the wiring against the pictorial diagrams. It is sometimes helpful to mark each lead on the diagram with a colored pencil as it is checked. This precludes the possibility of missing a connection. When satisfied that the wiring is complete and correct, proceed with the adjustment and testing of the instrument.

CAUTION: The voltages in this instrument are dangerous. Extreme care should be exercised whenever the instrument is connected to the AC line without being installed in its case. **DO NOT** connect the line cord to an AC outlet until you have read and fully understand the following instructions on testing the oscilloscope.

Some of the adjustments which must be made on the instrument cannot be performed with the cabinet in place. Whenever the O-9 is operated without the cabinet, be sure to remove the line cord from the outlet before attempting to change the position of the scope on the bench. Some of the highest voltages in the circuit appear on the INTEN. and FOCUS control terminals, just below the top edge of the panel. It is easy to get a finger on one of these terminals when moving the O-9 on the bench.

ADJUSTING THE OSCILLOSCOPE

- () Set the controls as follows **BEFORE** connecting the line cord to an AC outlet:
 - INTEN. - Full clockwise.
 - FOCUS - At approximate center of rotation.
 - HORIZONTAL CENTERING - At approximate center of rotation.
 - VERTICAL CENTERING - At approximate center of rotation.
 - VERT. GAIN - 0
 - FREQ. SELECTOR - Full clockwise.
 - HOR. GAIN - 0
 - VERT. INPUT - X100
 - FREQ. VERNIER - 50
 - PHASE - 50
 - SYNCHRONIZING - At approximate center of rotation.
 - HOR. SELECTOR - EXT. INPUT
 - Spot-Shape - At approximate center of rotation.
 - P-P Calibration - At approximate center of rotation.
 - OFF-ON - OFF

 - () Connect the line cord to a 105-125 volt 50-60 cycle AC outlet. **CAUTION:** This instrument will not operate and may be seriously damaged, if connected to a DC or 25 cycle AC power source, or to an AC line or more than 125 volts.
 - () Turn the OFF-ON switch to ON. This switch controls all power to the oscilloscope. When turned ON, the pilot light should light and all tube filaments should show color. Allow about one minute for the tube filaments to reach operating temperature.
 - () Watch the screen of the CR tube carefully until a green spot appears. Reduce the brightness of the spot at once by rotating the INTEN. control counterclockwise. Now adjust the FOCUS control to reduce the size of the spot to a minimum.
- CAUTION:** DO NOT PERMIT A HIGH INTENSITY SPOT TO REMAIN STATIONARY ON THE SCREEN FOR ANY LENGTH OF TIME. THIS MAY DESTROY THE FLUORESCENT MATERIAL ON THE SCREEN AND LEAVE A DARK SPOT.
- () Rotate the HORIZONTAL CENTERING control and notice that the spot moves horizontally across the screen. Now, using the VERTICAL CENTERING control, move the spot up and down. Adjust these two controls so that the spot is centered on the screen.

NOTE: If no spot appears, rotate both the HORIZONTAL and VERTICAL CENTERING controls simultaneously, since the controls may position the spot well off the screen. It may also be necessary to readjust the FOCUS and INTEN. controls to form the spot. If no spot can be seen, some error has been made in assembly or wiring. Refer to a later section of this manual, entitled IN CASE OF DIFFICULTY, for a trouble-shooting procedure.

- () With the spot centered on the screen, adjust the Spot Shape control (at the right rear corner of the chassis) so as to make the spot as round as possible. It may be necessary to readjust the FOCUS and INTEN. controls several times during this procedure as there is some interaction between the three circuits. The result should be a sharply defined spot of small size, the brightness of which can be varied with the INTEN. control. CAUTION: In making this adjustment, be careful not to touch any of the wiring at the rear of the chassis.
- () Using one of the test leads, connect a jumper from the 1 V. P-P terminal to the HOR. INPUT terminal. Turn the HOR. GAIN control clockwise. The spot should now become a horizontal line, whose length increases as the HOR. GAIN control is advanced. If the trace is not level, indicate the slope of the line with a wax pencil or crayon on the glass face of the CR tube. Turn off the power, loosen the tube clamp on the base of the CR tube, and rotate it slightly until the markings are horizontal. Tighten the clamp and check the trace to see that it is level. CAUTION: DO NOT ATTEMPT TO MAKE THIS ADJUSTMENT WITHOUT TURNING OFF THE INSTRUMENT. SOME SOCKET CONTACTS ON THE CR TUBE ARE APPROXIMATELY 1000 VOLTS "HOT". CONTACT TO THESE TERMINALS COULD EASILY BE FATAL.
- () Next, connect the jumper from the 1 V. P-P terminal to the VERT. INPUT terminals. Rotate the VERT. GAIN control clockwise and notice that the trace is now vertical and again is controlled in length by the setting of the control. Switch the VERT. INPUT control to X10. The line now can be extended to the full diameter of the screen at a fairly low setting of the VERT. GAIN control. Try the X1 position, and notice that full sweep can be obtained with a very small amount of vertical gain.
- () Set the HOR. SELECTOR switch to the INT. SYNC. position, the HOR. GAIN control to 100 (maximum gain), the VERT. INPUT switch to X100, and the VERT. GAIN control to 100. The trace should now become a series of lines across the screen. Now set the FREQ. SELECTOR to the line between 15 and 180, and adjust the FREQ. VERNIER to obtain a pattern consisting of four complete sine waves similar to that shown in Figure 31. This check indicates that the sweep generator is operating normally at a frequency of 60/4 or 15 cycles per second. Rotate the SYNCHRONIZING control slightly either way to lock the pattern on the screen. Reduce the HOR. GAIN setting if necessary.



Figure 31

- () Disconnect the jumper from the P-P INPUT terminal. Turn off the power and connect the free end of the jumper to terminal Z22 on the tube bracket. Set the FREQ. SELECTOR to the line between 180 and 1800, and the FREQ. VERNIER to 0. Now turn on the power. You should get a trace similar to that in Figure 32A or B. Reduce both gain control settings so that both ends of the trace are well within the screen.
- () Tighten the screw in the trimmer condenser on socket T until it is about 1/2 turn from tight. (This adjustment is provided for users who have access to laboratory-type square wave generators and is not critical unless the scope is used for observing square wave response at 500 kc or over. Under these conditions, the trimmer is adjusted for best square wave display at 500 kc.)

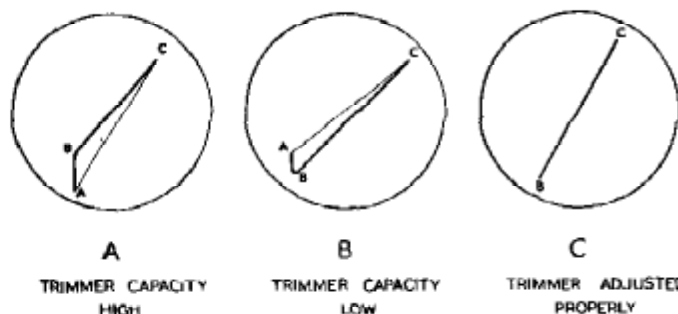

Figure 32

- () With the VERT. INPUT switch in the X10 position, adjust trimmer TT until the AB leg of the triangle disappears and only a straight sloping line is left.
- () Switch the VERT. INPUT switch to the X100 position and adjust trimmer UU to obtain the same result. In this adjustment you will notice that the slope of the BC portion of the trace is more nearly horizontal because of the lower vertical gain being employed. The adjustment can still be made very accurately. Turn power off and disconnect jumper from ZZ2.

NOTE: The adjustments just made are to compensate the vertical input attenuators so that they are not frequency conscious. This compensation preserves the excellent frequency response of the vertical amplifier even with high input attenuation.

- () Carefully trim the green plastic grid screen to size so that it slips snugly within the felt lined panel ring. Insert the screen so that it rests against the face of the tube.
- () Calibrate the 1 V. P-P voltage appearing at terminal VV on the front panel. This can be done as follows:

Connect a test lead from LR on the P-P CAL. control to the VERT. INPUT post of the scope. Set the VERT. INPUT switch at X10. Set the HOR. INPUT switch at EXT. INPUT. A single vertical line will be displayed. Using the VERT. GAIN control, adjust the length of this line so that it is exactly 1.3" in height, or 13 divisions. Turn off power. Now switch the VERT. INPUT switch to X1, disconnect the test lead from LR and connect to terminal VV on the panel. Turn on power. DO NOT CHANGE THE SETTING OF THE VERT. GAIN CONTROL, but adjust the P-P CAL. so that the vertical line is now exactly 1 1/2" long or 15 divisions.

NOTE: The above procedure will be sufficiently accurate for general applications requiring measurement of peak-to-peak voltages. It is based on the following relationships; with a 115 volt AC line voltage, the voltage appearing at LR will be one-half the filament voltage, or 3.15 V. AC RMS. This is equal to 3.15×2.828 or 8.92 V. P-P. The ratio of 8.92: 1.0 is very closely equal to the ratio of 130: 15. If the line voltage available at the time of calibration differs greatly from 115 volts, the same procedure may be used basing the ratios on the existing line voltage.

- () The chassis should now be installed in the cabinet. Pass the line cord through the large hole in the back of the cabinet, then slide the chassis in and fasten it in place using two #6 sheet metal screws through the back of the cabinet into the rear chassis apron.
- () Check the fit of the panel to the cabinet, remove the chassis and adjust the long panel braces by means of the slotted holes at the rear so that the panel is pulled up snugly against the front edge of the cabinet. The chassis should then be replaced and again secured to the cabinet as shown.

This completes the construction and adjustment of your Heathkit model O-9 Oscilloscope.

OPERATION OF THE OSCILLOSCOPE

The operation of an oscilloscope and its many controls is quite simple once the basic principles are clear.

The controls can be divided into groups with specific functions.

Two knobs, marked INTEN. and FOCUS, control the quality of the trace. The INTEN. knob adjusts the brightness and the FOCUS knob the sharpness of the trace on the oscilloscope screen.

Two knobs, marked VERTICAL CENTERING and HORIZONTAL CENTERING, control the location of the trace on the screen. Turning the vertical knob shifts the trace up or down, and the horizontal knob moves the trace to left or right on the oscilloscope screen.

One knob, marked HOR. GAIN, varies the width of the pattern on the oscilloscope screen.

Two knobs, marked VERT. GAIN and VERT. INPUT, control the height of the pattern on the screen.

Three knobs, marked **FREQ. SELECTOR**, **FREQ. VERNIER**, and **SYNCHRONIZING** control the operation of the sweep generator. The selector switch and vernier control permit selection of a suitable sweeping rate to provide a clear pattern. The synchronizing knob provides the stabilizing action needed to keep the pattern from drifting left or right.

The **PHASE** knob controls the phase shift of the line frequency signal voltage used for sinusoidal sweep or for line-synchronized sawtooth sweep.

The **HOR. SELECTOR** switch performs the following functions:

EXT. INPUT: The **HOR. INPUT** binding post is connected directly to the input grid of the horizontal amplifier system. The sweep generator is non-operating.

LINE SWEEP: Line frequency voltage, controlled in phase by the **PHASE** control, is applied to the horizontal amplifier system. The sweep thus applied is sinusoidal in wave-form.

LINE SYNC. SWEEP: The sweep generator is operating, furnishing saw-tooth sweep at any frequency within its range, but synchronized with the line frequency or its harmonics.

INT. SYNC. SWEEP: The sweep generator is operating, furnishing saw-tooth sweep at any frequency within its range, synchronized with the signal applied at the **VERT. INPUT** binding post.

EXT. SYNC. SWEEP: Same as above, but synchronized with the signal at the **EXT. SYNC.** binding post.

NOTES ON THE OPERATION OF THE OSCILLOSCOPE

At maximum gain settings, the sensitivity of the amplifiers is very high. Therefore, without a signal source connected to the input terminals, stray pickup may produce patterns on the screen. This is equivalent to the noise obtained from high gain audio amplifiers when the pickup or the microphone is disconnected. Such behavior is a normal characteristic of the instrument and does not interfere with proper operation.

The maximum undistorted output voltage of the amplifiers generally does not provide deflection much in excess of five inches. Maximum deflection of four inches, both horizontal and vertical, will provide adequate utilization of the available screen area.

At low sweep rates (30 cycles or less), the screen has insufficient persistence to provide a steady picture. This flicker is inherent with medium persistence screens at low sweep rates.

IN CASE OF DIFFICULTY

If the testing procedure described does not produce the expected results, the following procedure is recommended:

1. Check the wiring against the pictorial diagrams. Follow each wire in the instrument and check the connections at each end for good solder joints and for termination at the proper points. Checking each lead off in colored pencil on the pictorial as it is compared with the instrument will sometimes reveal an error consistently overlooked. Mistakes in wiring are responsible for the majority of troubles experienced by kit builders.
2. Check the voltages at the tube socket terminals. The readings should compare with the table on Page 29, within 25%. These measurements were made with a Heathkit VTVM with an input resistance of 11 megohms. Voltage checks made with instruments of other input characteristics may vary greatly. Should a discrepancy in voltage readings show up, carefully check the components associated with that tube.

3. Check the values of the component parts. Be sure that the proper part has been wired into the circuit, as shown in the pictorial diagram and as called out in the wiring instructions.
4. Should the procedure as outlined fail to correct your difficulty, write to the Heath Company describing the nature of the trouble by giving all possible details, including voltage readings obtained and other indications you may have noticed. We will try to analyze your trouble and advise you accordingly. No charge is made for this service.

IN ALL CORRESPONDENCE, REFER TO THIS INSTRUMENT AS THE MODEL O-9 OSCILLOSCOPE.

REPLACEMENTS

Material supplied with Heathkits has been carefully selected to meet design requirements and ordinarily will fulfill its function without difficulty. Occasionally improper instrument operation can be traced to a faulty tube or component. Should inspection reveal the necessity for replacement, write to the Heath Company and supply all of the following information:

- A. Thoroughly identify the part in question by using the part number and description found in the manual parts list.
- B. Identify the type and model number of kit in which it is used.
- C. Mention the order number and date of purchase.
- D. Describe the nature of defect, or reason for requesting replacement.

The Heath Company will promptly supply the necessary replacement. Please do not return the original component until specifically requested to do so. Do not dismantle the component in question as this will void the guarantee. If tubes are to be returned, pack them carefully to prevent breakage in shipment as broken tubes are not eligible for replacement. This replacement policy does not cover the free replacement of parts that may have been broken or damaged through carelessness on the part of the kit builder.

SERVICE

In event continued operational difficulties of the completed instrument are experienced, the facilities of the Heath Company Service Department are at your disposal. Your instrument may be returned for inspection and repair for a service charge of \$5.00 plus the cost of any additional material that may be required. **THIS SERVICE POLICY APPLIES ONLY TO COMPLETED INSTRUMENTS CONSTRUCTED IN ACCORDANCE WITH THE INSTRUCTIONS AS STATED IN THE MANUAL.** Instruments that are not entirely completed or instruments that are modified in design will not be accepted for repair. Instruments showing evidence of acid core solder or paste fluxes will be returned not repaired.

The Heath Company is willing to offer its full cooperation to assist you in obtaining the proper operation of your instrument and therefore this factory repair service is available for a period of one year from the date of purchase.

SHIPPING INSTRUCTIONS

Before returning a unit for service, be sure that all parts are securely mounted. Attach a tag to the instrument giving name, address and trouble experienced. Pack in a rugged container, preferably wood, using at least three inches of shredded newspaper or excelsior on all sides. **DO NOT SHIP IN THE ORIGINAL KIT CARTON AS THIS CARTON IS NOT CONSIDERED ADEQUATE FOR SAFE SHIPMENT OF THE COMPLETED INSTRUMENT.** Ship by prepaid express if possible. Return shipment will be made by express collect. Note that a carrier cannot be held liable for damage in transit if packing, in HIS OPINION, is insufficient.

SPECIFICATIONS

All prices are subject to change without notice. The Heath Company reserves the right to discontinue instruments and to change specifications at any time without incurring any obligation to incorporate new features in instruments previously sold.

WARRANTY

The Heath Company limits its warranty of parts supplied with any kit (except tubes, meters and rectifiers, where the original manufacturer's guarantee only applies) to a period of three (3) months from the date of purchase. Replacement will be made only when said part is returned postpaid, with prior permission and in the judgment of the Heath Company was defective at the time of sale. This warranty does not extend to any Heathkits which have been subjected to misuse, neglect, accident and improper installation or applications. Material supplied with a kit shall not be considered as defective, even though not in exact accordance with specifications, if it substantially fulfills performance requirements. This warranty is not transferable and applies only to the original purchaser. This warranty is in lieu of all other warranties and the Heath Company neither assumes nor authorizes any other person to assume for them any other liability in connection with the sale of Heathkits.

The assembler is urged to follow the instructions exactly as provided. The Heath Company assumes no responsibility or liability for any damages or injuries sustained in the assembly of the device or in the operation of the completed instrument.

WIRING OF EXPORT TYPE

110/220 VOLT POWER

TRANSFORMERS

These transformers have a dual primary for use on either 110 Volts or 220 Volts Wire as shown.

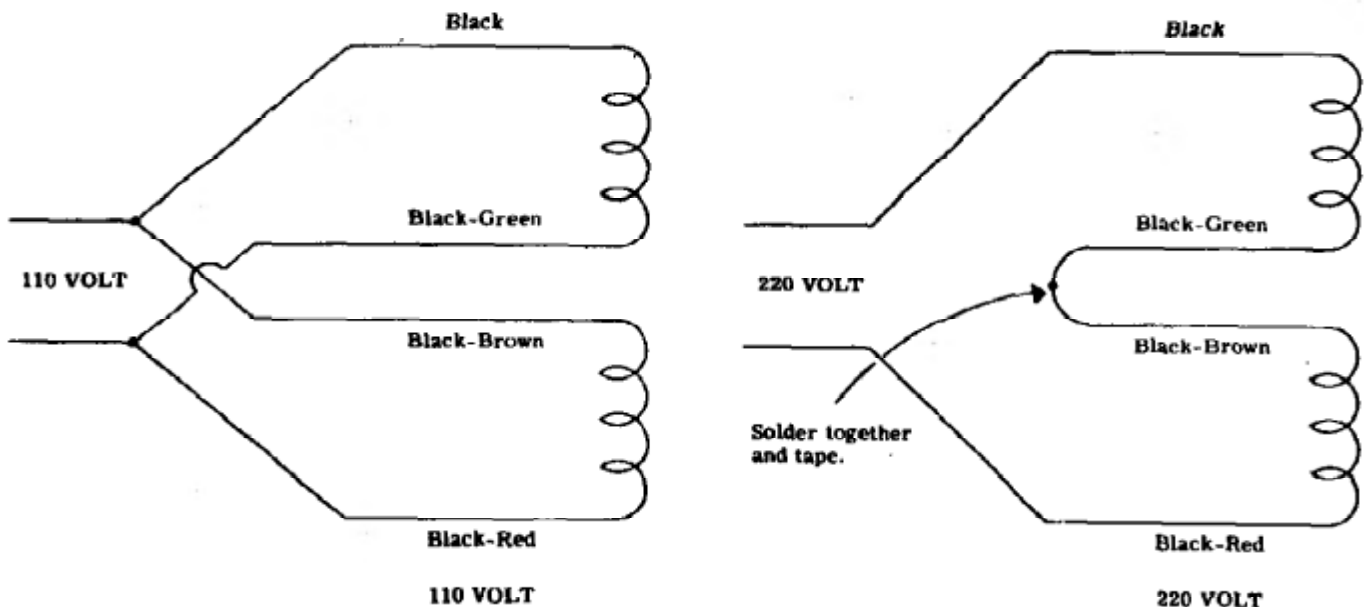

SOCKET VOLTAGE CHART

SOCKET TUBE TYPE	Pin 1	Pin 2	Pin 3	Pin 4	Pin 5	Pin 6	Pin 7	Pin 8	Pin 9
A 6AB4	138	NC	H	H	NC	8	12		
B 12AU7	133	NS	6.5	H	H	137	NS	4.4	H
C 12AT7	99 Note 1	0	1.8 Note 1	H	H	25 Note 1	-4.6 Note 1	1.8 Note 1	H
D 5Y3	NC	750 AC	NC	-1050	NC	-1050	NC	750 AC	
E 5Y3	NC	325	NC	280 AC	NC	280 AC	NC	325	
R 12AT7	42	0	0.25	H	H	40	NS	0	H
S 6C4	97	NC	H	H	Note 2	40	40		
T 12AT7	220 Note 3	NS	2.4 Note 3	H	H	220 Note 3	0	2.4 Note 3	H
V 12AT7	155 Note 3	NS	1.9 Note 3	H	H	155 Note 3	NS	1.9 Note 3	H
CRT 5UP1	-940 Note 4	-850	-940 Note 4	-585 Note 4	NC	220 Note 3	220 Note 3	225 Note 5	155 Note 3
	Pin 10	Pin 11	Pin 12						
	155 Note 3	NC	-920 Note 4						

NOTE: Socket F is the voltage regulator tube. Pin 5 will show 150 volts DC above chassis and Pin 2 is grounded. No connection is made to the other pins.

NC - No connection.

H - Heater terminal, heater voltage 6.3 V AC, all tubes.

NS - Not significant.

Note 1 - Varies with sweep generator control settings.

Note 2 - Connected to Pin 1 internally.

Note 3 - Varies with centering control settings.

Note 4 - Varies with focus and/or intensity control settings.

Note 5 - Varies with Spot-Shape control setting.

Unless otherwise indicated, all voltage are positive and measured to chassis.

Line voltage: 115 volts 60 cycles.

Sweep Generator operating at approximately 1000 cps.

No signal input to vertical amplifier.

All measurements made with vacuum tube voltmeter; 11 megohms input resistance.

SOME OSCILLOSCOPE APPLICATIONS

As mentioned in the introduction to this manual, the cathode ray oscilloscope is a most versatile device. It has the unique ability to measure the basic electrical quantities and, more important, to show the relationships between as many as three of these quantities at any one time. Or, it can relate one or two of the variables against a controlled time reference. Therefore, it can indicate such characteristics as frequency, phase relations, and waveform.

By the use of supplementary devices, called transducers, a great variety of other physical attributes can be investigated with the oscilloscope. These transducers are used to convert sound, heat, light, stress or physical movement into electrical impulses. The impulses can be studied by displaying them on the screen of the oscilloscope.

The following portion of this manual is simply to familiarize you with the basic applications of your oscilloscope. Each one of the uses described is well within the capabilities of the Heathkit model O-9 Oscilloscope.

WAVEFORM INVESTIGATION

Probably the major use of most oscilloscopes is in the study of recurrent or transient variations in an electrical quantity. Since the oscilloscope is a voltage-operated device, these variations must be first converted into changes in voltage.

It is common practice to apply the signal voltage to the vertical input to the oscilloscope. By means of attenuators and amplifiers, this voltage is made to displace vertically the electron beam in the cathode ray tube. At the same time, the beam is being swept horizontally by the sweep generator within the instrument. The sweep frequency is normally a sub-harmonic or simple fraction of the signal frequency. Therefore, more than one complete cycle of the signal is shown on the screen.

With this brief background, we have described below the more common applications of the oscilloscope in studying waveforms.

Testing Audio Amplifiers and Circuits

Figure 33 shows the conventional set-up of equipment for this application. The audio generator should be capable of producing a pure sine wave with very low harmonic distortion. The load resistor should match the output impedance of the amplifier. The usual practice is to perform all tests at an input voltage sufficient to develop a reference power output. This prevents overloading of any portion of the amplifier and consequent inaccuracies in measurements.

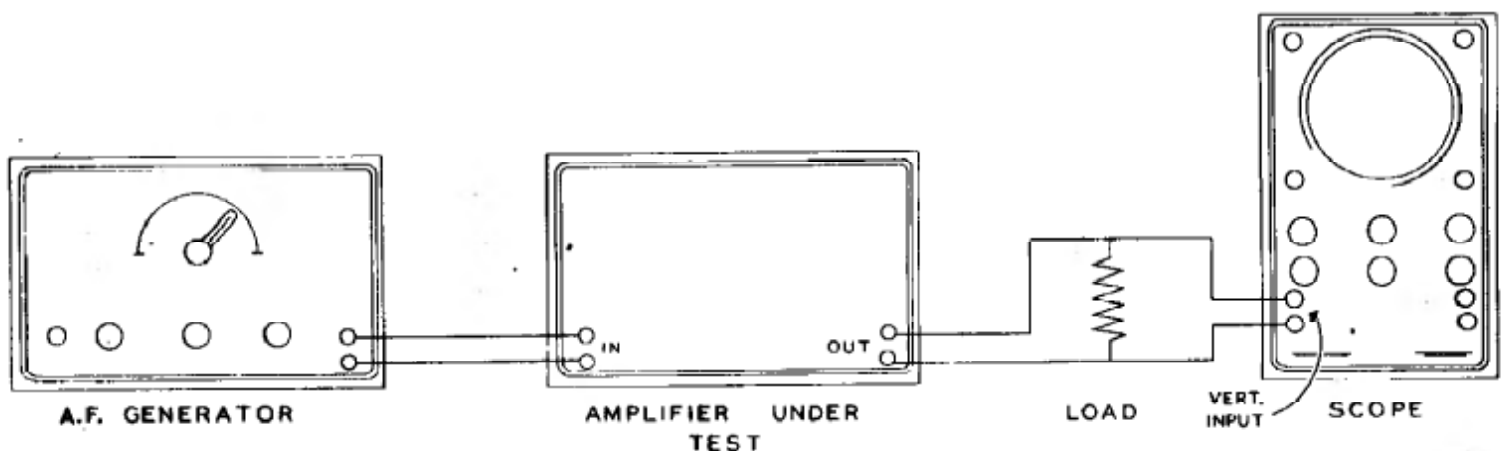

Figure 33

Figure 34A shows serious flattening of one peak, representing about 10% harmonic distortion. This condition may be caused by incorrect bias on any stage, or by an inoperative tube in a push-pull stage. Figure 34B indicates third harmonic distortion, a particularly objectionable fault. Figure 34C shows flattening of both peaks, usually an indication of over-load somewhere in the circuit.

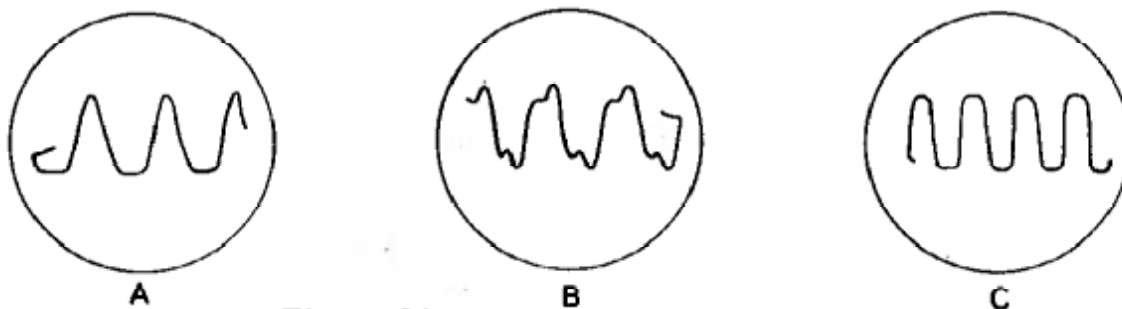

Figure 34

Although the use of sine-wave input tells us a lot about an amplifier, the use of a square-wave input waveform gives a very accurate and extremely sensitive indication of the performance of the system with respect to both amplitude distortion and phase shift. Assume that we apply a wave of the form shown in Figure 35A, with a fundamental frequency of 60 cycles. In a theoretically perfect amplifier, the output waveform would be an exact duplicate except at a greater power level as determined by the gain of the amplifier. Actually, the distortion of this waveform as shown in the scope tells a great deal about the amplifier at frequencies considerably separated from the test frequency. If the high frequency performance of the amplifier is excellent, the front of the square wave will be sharp cornered and clean. A distortion similar to

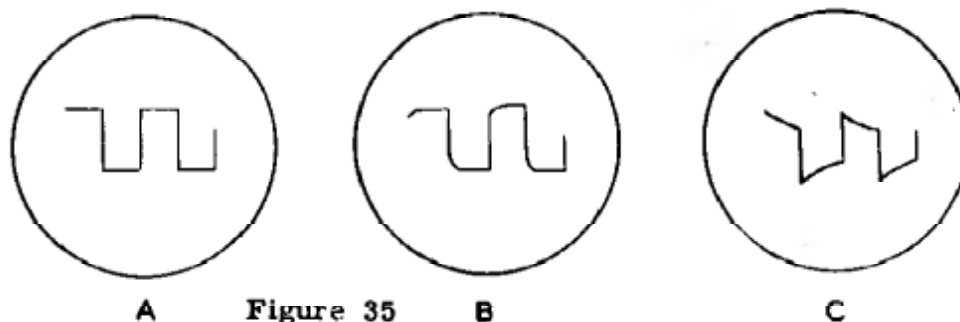

Figure 35

that shown in Figure 35B indicates poor high frequency response, which may be amplitude distortion, phase shift, or both. We may assume, therefore, that the shape of the rising portion of the waveform indicates the ability of the amplifier to faithfully reproduce high frequencies. Conversely, the slope of the flat-top portion of the wave indicates the performance of the amplifier in the low frequency range. Figure 35C is the characteristic indication of an amplifier with poor low frequency response.

Again, the square-wave generator used must be capable of producing the desired waveform with excellent voltage regulation and low inherent distortion. The Heathkit model AO-1 Audio Oscillator is recommended.

Further discussion of this method is beyond the scope of this manual. Interested readers are referred to the bibliography for further sources.

Servicing Television Receivers

Servicing of television receivers is a rapidly expanding application of the cathode ray oscilloscope. Each of the following basic uses requires some additional equipment, but none of them can be performed without using the oscilloscope. This particular field has been given specific attention in the design of the Heathkit model O-9.

1. Alignment of a television receiver is virtually impossible without the use of an oscilloscope and a television alignment generator, such as the Heathkit model TS-3. This generator supplies an RF signal over all the frequencies involved in modern television receiver operation. The signal can be frequency-modulated at 60 cycles per second with a deviation of several megacycles. The generator also provides a 60 cycle sweep voltage, controllable in phase, to drive the horizontal deflection amplifiers in the oscilloscope. It also provides a blanking system which cuts off the RF output of the generator during one-half of its operating cycle. In effect, the generator output starts at a base frequency and sweeps at a uniform rate from the base frequency to a frequency several megacycles above. The oscillator output is then cut off, and the cycle is repeated. The vertical input to the scope is driven by the voltage developed at the input to the video amplifier. Since this voltage varies in exact accordance with the gain of the RF and/or IF amplifier stages over the frequency range being swept, the trace on the scope screen is actually a graphic representation of the response of the amplifiers being tested.

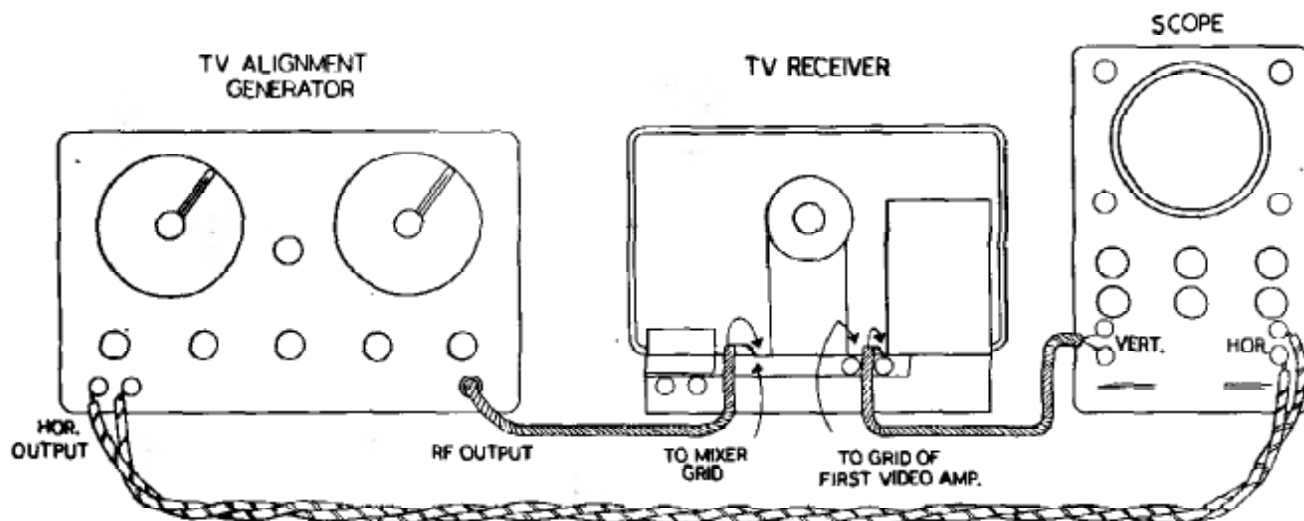

Figure 36

Figure 36 outlines the connections between the alignment generator, the receiver, and the oscilloscope. The exact procedure for alignment varies greatly. This information is generally available in the manufacturer's service information. Usually, a drawing of the desired response curve is given, together with a sequence of adjustments to roughly approach the desired pattern. Final adjustments are made while watching the trace on the oscilloscope.

2. Waveform of the complex television picture signal as it is passed through the receiver is undoubtedly the most important characteristic of the signal voltage. In order to properly display the minute variations in waveform, which incidentally make the difference between good and bad picture quality, the oscilloscope is required to attenuate, amplify, and display voltage changes over an extremely wide frequency range without in any way distorting them. The performance of the Heathkit model O-9 is entirely for this application.

Again, you must rely upon the manufacturer to furnish representative patterns showing the waveform to be expected at specific test points within the receiver. You will find that these diagrams cover the entire receiver with the exception of the "front-end" or tuner portion. However, in order to pick off the modulation envelope in the IF or video amplifier sections, a demodulator probe is used to make connection to the plate, grid, or cathode of the stage being investigated. This is necessary since the signal in these stages is still contained in the amplitude-modulated envelope of the carrier and must be detected, or demodulated, before it can be shown on the oscilloscope. The Heathkit #337-B Demodulator Probe is designed for this purpose. At any point after the video detector, no such probe is necessary and a simple shielded low-capacity cable can be used.

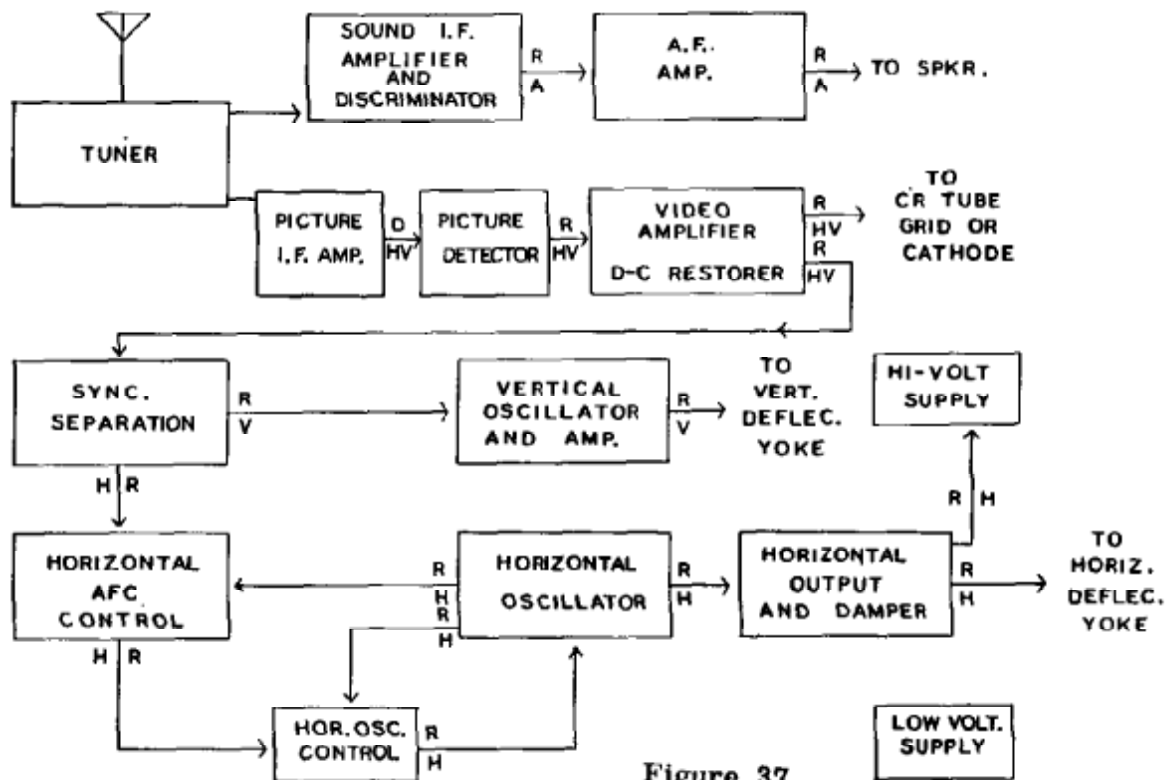

Figure 37

OPERATE OSCILLOSCOPE AS SHOWN BELOW:

- R Use direct input
- D Use demodulated input
- H Use 7,875 or 15,750 cps sweep
- V Use 20, 30, or 60 cps sweep
- A Use audio test frequency sweep, or half this frequency

NOTE: For simplicity, all amplifier stages are shown within one block in the diagram. Tests may be made at the input or output of individual amplifier stages using the indicated mode of operation.

In either case, the signal voltage is fed into the vertical amplifier of the oscilloscope as shown in Figure 37. At any point up to the video detector, the voltages picked off will be quite small, and very little vertical attenuation will be required. Within the sync circuits and deflection circuits, however, these voltages can reach very respectable proportions, and considerable attenuation is required. It is for this reason that the vertical input section of the O-9 utilizes fully compensated attenuators. Any other method of reducing such voltages would result in enough distortion to render the displayed signal completely useless.

In checking waveform, remember that two basic frequencies are involved in the television signal. The vertical, or field frequency is 60 cycles per second. Any investigation of the circuit, except within the horizontal oscillator, its differentiator network, and the horizontal amplifier stages, can generally be made using a sweep generator frequency of 20 to 30 cycles, thus showing two or three complete fields of the signal. In order to study the horizontal pulse shape, or the operation of the horizontal deflection system, it is generally necessary to operate the sweep generator at 15,750 or 7,875 cycles per second. This sweep rate will show the waveform of one or two complete lines of the signal.

The signal-tracer method of analysis is most helpful in going through a receiver in this fashion, since faulty receiver operation is generally caused by the loss of all or a significant portion of the picture information and pulses at some stage within the receiver. With a basic understanding of the function of each part of the signal, and with the means available to determine what the signal actually looks like at any part of the receiver, it is a comparatively simple matter to isolate the defective portion, and the particular component, causing the failure.

Remember, in making connections to the test points, that grid circuits are generally high-impedance points, and that the addition of any capacity can disrupt the performance of the stage to some degree. Plate circuits and cathode circuits are usually lower-impedance points, and more desirable for testing purposes. Also, bear in mind that the plate-circuit indication with respect to polarity will be exactly opposite to indications obtained on grid or cathode, since a phase difference of 180 degrees takes place within the tube. Therefore, the pattern shown on the scope screen may be inverted when such interchanges are made. The form of the wave will not be changed, however.

3. Video amplifier response can be measured in exactly the same manner described for testing audio amplifiers, and again a square-wave signal is the most efficient method to use. Because a video amplifier must pass signals as low as 20 cycles and as high as 4 or 5 megacycles, however, a more comprehensive test is required. Usually a 60 cycle check is made to cover low and medium-frequency characteristics. A second check at 25,000 cycles covers the high-frequency portion of the response curve. Again, such tests require extreme fidelity on the part of the oscilloscope, and these requirements are fully met by the Heathkit model O-9. The signal-tracing technique can be used in these tests also. The square-wave generator is fed directly into the first video amplifier grid. Very low signal input will be required. Then the oscilloscope is connected to various plates, starting near the output end and working back until any distortion is isolated. Patterns such as Figure 35B are responsible for poor picture detail, or "fuzziness," while distortion of the form shown in Figure 35C can cause shading of the picture from top to bottom.

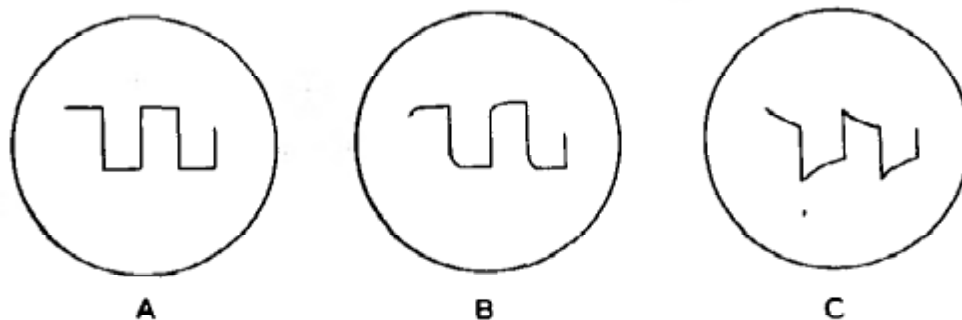

Figure 35

Miscellaneous Waveform Measurements

In this category, we can place such waveform investigations as measurement of modulation percentage, studies of noise and vibration, sub-sonic and super-sonic applications and hundreds of others. Each of these fields is highly specialized, and it is obviously impossible to cover them here. We again refer you to the bibliography for further reading in this field.

AC VOLTAGE MEASUREMENTS

Because of its peculiar characteristics, the oscilloscope is particularly suited to the measurement of AC voltages. With the advent of television, it has become imperative that such measurements be made accurately without respect to wave-shape, so that the conventional RMS reading AC voltmeter is no longer adequate. Most television service bulletins specify peak-to-peak voltages which appear at various points of the circuit. Other applications for such measurements are becoming more common every day.

The O-9 oscilloscope has been designed to accurately measure and display these voltages. Former instructions have shown how to calibrate the instrument for direct measurement of peak-to-peak amplitudes. The attenuators are especially designed for maximum accuracy, and readings can be relied on to within ± 2 db when referred to a calibration voltage of the same frequency. An additional error of 1 db may be encountered when the calibrating voltage and the signal voltage are greatly different in frequency.

When using the grid screen for AC voltage measurements, it is sometimes helpful to use the EXT. INPUT setting for the HOR. SELECTOR switch. This produces a vertical line which can be focused and centered exactly for most accurate readings.

The following relationships exist between sine wave AC voltages:

- RMS times 1.414 gives peak voltage.
- RMS times 2.828 gives peak-to-peak voltage.
- Peak voltage times 0.707 gives RMS voltage.
- Peak-to-peak voltage times 0.3535 gives RMS voltage.

AC CURRENT MEASUREMENTS

To measure AC currents, the unknown current must be passed through a resistor of known value. The voltage drop across this resistor is measured as described above. From Ohm's law, I equals E/R , the current can be calculated. It is important that the resistor be non-reactive at the frequency involved. It should also be relatively small with respect to the resistance of the load.

FREQUENCY MEASUREMENTS

Frequency measurements can be made with an accuracy limited only by the reference frequency source available. In most cases, this can be the 60 cycle line frequency which is usually controlled very closely. The unknown frequency is applied to the vertical input, and the reference frequency to the horizontal input. (Sweep generator input is not used.) The resultant pattern may take on any one of a number of shapes. Typical patterns are shown below:

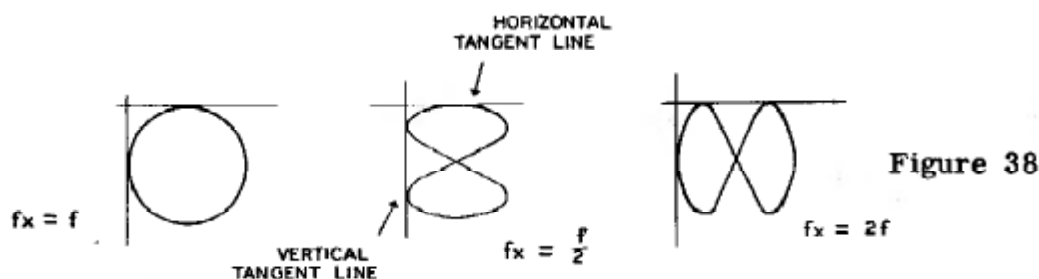

The frequency ratio can be calculated from the formula:

$$f_x = \frac{T_h \times f}{T_v}$$

where f_x is the unknown frequency; T_h is the number of loops which touch the horizontal tangent line; T_v is the number of loops which touch the vertical tangent line.

When using Lissajous patterns, as these curves are called, it is good practice to have the figure rotating slowly rather than stationary. This eliminates the possibility of an error in counting the tangent points. If the pattern is stationary, a double image similar to the figure below may be formed. In such cases, the end of the trace should be counted as one-half a tangent point rather than a full point. This condition may occur when neither frequency can be varied.

PHASE MEASUREMENTS

It is sometimes necessary to determine the phase relationship between two AC voltages of the same frequency. This can be accomplished quite easily by applying one of the voltages to the horizontal input and the other voltage to the vertical input. The phase relationship can be estimated from the figures below:



Figure 39

To calculate the phase relationship, use the following formula: $\sin \Theta = \frac{A}{B}$

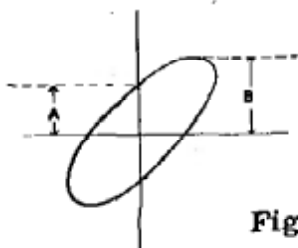

Figure 40

The distance A is measured from the X axis to the intercept point of the trace and the Y axis. The distance B represents the height of the pattern above the X axis. The axes of the ellipse must pass through the point O.

CAUTION: The terminals on the rear terminal board are approximately 300 volts above chassis in some cases. Such voltages can be fatal. Do not attempt to make connection to these terminals without first pulling the line cord from its socket.

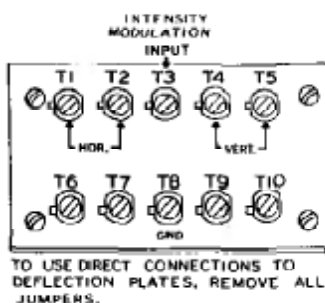

Figure 41

USE OF DIRECT DEFLECTION CONNECTIONS

Located on the rear of the cabinet is a small cover plate which may be removed to gain access to the direct-deflection plate terminals. Normal use of the oscilloscope requires wire jumpers as shown in Figure 16.

For certain applications, it is desirable to connect directly to the deflection plates within the cathode ray tube. Under these conditions, the sensitivity of the instrument is greatly reduced, but the power required from the driving source is extremely low and is simply the capacitive loss entailed by the interelectrode capacity of the tube elements, plus the wiring capacities to ground. In the model O-9, these strays have been reduced as much as possible.

The following information may be of benefit in using the instrument in this way:

A positive voltage applied to T1, with T2 negative, will deflect the beam to the left.

A positive voltage applied to T5, with T4 negative, will deflect the beam upward.

An RMS potential of 20 volts will deflect the beam approximately 1", when applied to either set of plates.

USE OF INTENSITY MODULATION TERMINALS

Terminal T3 on the rear terminal plate is connected to the control grid of the CR tube through a high-voltage coupling condenser. An RMS voltage of approximately 15 volts applied between T3 and T8 (ground) will be sufficient to modulate the intensity of the beam so that it is completely blanked on negative peaks. This method is very convenient to develop a timing marker on the trace, giving it a dotted line appearance. If the frequency of the modulating voltage is known, the time interval between markers can be computed. Accuracy is, of course, dependent upon the source of the voltage. Either square or sine wave intensity modulation may be used, depending upon the application. Square wave modulation will generally give a more accurately defined break in the trace. When using intensity modulation, be sure to remove from terminal T3, the lead connected to pin 6 on socket B. This will disable the return trace blanking.

PARTS LIST

PART No.	PARTS Per Kit	DESCRIPTION	PART No.	PARTS Per Kit	DESCRIPTION
Resistors			Controls		
1-3	1	100 Ω 1/2 watt	11-17	1	100 Ω CALIBRATION
1-45	1	220 Ω 1/2 watt	10-7	1	5 K Ω VERT. GAIN
1-6	2	470 Ω 1/2 watt	10-10	1	20 K Ω VERTICAL CENTERING
1-7	2	680 Ω 1/2 watt	10-11	1	50 K Ω HORIZONTAL CENTERING
1-9	2	1 K Ω 1/2 watt	10-12	1	100 K Ω Spot-Shape
1-10	1	1.2 K Ω 1/2 watt	10-13	1	200 K Ω CT SYNCHRONIZING
1-14	1	3.3 K Ω 1/2 watt	10-14	1	250 K Ω PHASING
1-73	1	8.2 K Ω 1/2 watt	10-26	1	500 K Ω INTENSITY
1-20	3	10 K Ω 1/2 watt	10-32	1	1 megohm FOCUS
1-69	1	18 K Ω 1/2 watt	12-3	1	1-8 megohm dual FREQUENCY
1-22	1	22 K Ω 1/2 watt	12-1	1	5 K Ω dual HOR. GAIN
1-76	1	33 K Ω 1/2 watt	Switches		
1-25	2	47 K Ω 1/2 watt	60-1	1	SPST slide switch
1-26	1	100 K Ω 1/2 watt	63-47	1	1 sec. 3 pos. rotary switch VERT. INPUT
1-27	2	150 K Ω 1/2 watt	63-64	1	2 sec. 5 pos. rotary switch HOR. INPUT
1-29	1	220 K Ω 1/2 watt	63-8	1	2 sec. 4 pos. rotary switch FREQ. SELECTOR
1-77	2	390 K Ω 1/2 watt	Tubes-Lamps		
1-33	3	470 K Ω 1/2 watt	411-3	2	5Y3GT tube
1-34	2	680 K Ω 1/2 watt	411-4	1	6C4 tube
1-68	2	820 K Ω 1/2 watt	411-24	4	12AT7 tube
1-35	1	1 megohm 1/2 watt	411-25	1	12AU7 tube
1-78	4	3.3 megohm 1/2 watt	411-32	1	VR-150-30 tube
1-40	4	10 megohm 1/2 watt	411-49	1	5UP1 cathode ray tube
1-70	2	22 megohm 1/2 watt	411-58	1	6AB4 tube
1-19A	1	220 Ω 1 watt	412-1	1	#47 panel lamp
1-2A	1	1 K Ω 1 watt	Wire		
1-24A	2	4.7 K Ω 1 watt	340-2	1	length Bare wire
1-5A	3	22 K Ω 1 watt	341-1	1	length Black test lead wire
1-30A	1	220 K Ω 1 watt	341-2	1	length Red test lead wire
1-34A	1	1 megohm 1 watt	344-1	1	length Hook-up wire
1-37A	1	3.3 megohm 1 watt	346-1	1	length Sleeving
3-2D	1	6 K Ω 4 watt	347-2	1	length 300 Ω line
3-3E	1	1 K Ω 5 watt	89-1	1	Line cord
Condensers			100-38	1	Cable assembly
21-6	1	27 μmf	Sockets-Terminal Strips		
21-9	1	100 μmf	434-2	3	Octal tube socket
20-4	2	270 μmf	434-15	2	7-pin miniature tube socket
21-14	1	1000 μmf	434-16	5	9-pin miniature tube socket
20-7	1	2000 μmf	434-22	1	Pilot light socket
31-3	1	300-450 μmf trimmer	434-41	1	12-pin CRT socket
31-6	2	5-20 trimmer	431-1	2	1-lug terminal strip
23-3	1	.01 μfd 400 v paper tubular	431-2	2	2-lug terminal strip
23-8	3	.02 μfd 600 v paper tubular	431-10	2	3-lug terminal strip
23-10	3	.05 μfd 600 v paper tubular	431-5	1	4-lug terminal strip
23-13	3	.25 μfd 600 v paper tubular	431-12	1	4-lug terminal strip
23-32	5	.1 μfd 600 v paper	431-11	2	5-lug terminal strip
23-15	1	.5 μfd 400 v paper tubular	431-9	1	10-screw terminal board
25-27	1	2-2 μfd 450 v electrolytic			
25-2	1	8 μfd 475 v electrolytic			
25-21	1	20-20-20-20 μfd 450 v			
25-28	1	100 μfd 50 v			
23-29	1	.1 μfd 1200 v			
23-30	1	.2 μfd 1200 v			
23-31	1	.05 μfd 1600 v			

<u>PART No.</u>	<u>PARTS Per Kit</u>	<u>DESCRIPTION</u>	<u>PART No.</u>	<u>PARTS Per Kit</u>	<u>DESCRIPTION</u>
Hardware			Sheet Metal Parts		
250-2	14	3-48 x 1/4" machine screw	90-25	1	Cabinet
250-8	5	#6 x 3/8 sheet metal screw	200-M56	1	Chassis
250-9	37	6-32 x 3/8 machine screw	203-44F56	1	Panel
250-13	6	6-32 x 1 machine screw	204-9	1	Angle bracket
250-18	4	8-32 x 3/8 machine screw	204-M37L	1	Panel bracket, triangular, lh
250-19	2	10-24 x 3/8 machine screw	204-M37R	1	Panel bracket, triangular, rh
250-22	8	8-32 x 3/8 set screw	204-M58	1	Tube support bracket
250-25	2	4-40 machine screw	204-M53L	1	Panel bracket, long, lh
252-1	14	3/48 hex nut	204-M53R	1	Panel bracket, long, rh
252-3	48	6-32 hex nut	205-M26	1	Shield plate
252-4	4	8-32 hex nut	207-M1	2	Tube clamp
252-7	14	3/8-32 hex nut	210-M1	1	Panel ring assembly
252-12	1	Pilot light nut	211-1	1	Handle
253-1	4	#6 flat fiber washer	Miscellaneous		
253-2	4	#6 shoulder fiber washer	45-5	2	Choke, 150 μ h
253-10	13	Flat control washer	54-19	1	Power transformer
253-15	1	Flat fiber control washer	70-2	1	Insulator, black, for banana plug
253-16	1	Shoulder fiber control washer	70-3	1	Insulator, red, for banana plug
254-1	36	#6 lockwasher	73-1	1	3/8 grommet
254-2	4	#8 lockwasher	73-2	2	3/4 grommet
254-4	13	Control lockwasher	73-5	1	Cushion strip
254-6	2	#6 external tooth lockwasher	413-1	1	Pilot lamp jewel
255-5	4	#6 x 3/4 spacer	455-1	1	Pilot lamp bushing
259-1	12	#6 solder lug	414-2	1	Grid screen
Knobs-Terminals			421-1	1	Fuse
100-M16B	4	Binding post cap assembly, black	422-1	1	Fuse block
100-M16R	2	Binding post cap assembly, red	481-1	1	Condenser mounting wafer
427-2	6	Binding post base	261-1	4	Rubber feet
260-1	2	Alligator clip	595-74	1	Manual
438-M8	2	Banana plug w/sleeve			
462-4	4	Acorn knob			
462-M11	8	Pointer knob, drilled and tapped			

BIBLIOGRAPHY

While many issues of the popular radio and service magazines have carried excellent articles on the construction and application of oscilloscopes, and their reading is highly recommended, we also suggest the following excellent books:

- RUITER, Modern Oscilloscopes and Their Uses
- SYLVANIA, How to Service Radios With an Oscilloscope
- HICKOK, How to Use the CR Oscilloscope in Servicing Radio and TV
- RIDER, The Cathode Ray Tube at Work
- TURNER, Radio Test Instruments
- EDITORS and ENGINEERS, Radio Handbook
- A. R. R. L., Radio Amateurs Handbook
- RIDER and USLAN, Encyclopedia on Cathode Ray Oscilloscopes and Their Uses