

PRICE \$2.00

RECEIVED JUN 21 1961

HEATHKIT® ASSEMBLY MANUAL

HEATHKIT® by DAYSTROM

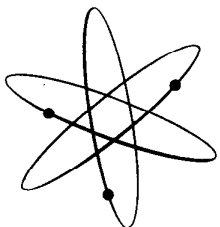

T U B E C H E C K E R
MODEL TC-3

ASSEMBLY AND OPERATION OF THE HEATHKIT TUBE CHECKER MODEL TC-3



SPECIFICATIONS

Power Requirements:.....	105-125 volts 50/60 cycle AC.
Dimensions:.....	13" wide x 8 1/2" high x 5 1/2" deep.
Element Test Voltages:.....	30, 100, 250 volts AC.
Filament Voltages:.....	.63, 1.4, 2, 2.35, 2.5, 3.15, 4.2, 4.7, 5, 6.3, 7.5, 9.45, 12.6, 19.6, 25, 32, 50, 70, 110 volts AC.
Roll Chart Mechanism:.....	Constant tension, free rolling, thumbwheel operated, illuminated.
Line Voltage Adjustment:.....	Step type
Meter:.....	1 ma full scale deflection BAD - ? - GOOD scale, illuminated
Socket Accommodations:.....	4 pin, 5 pin, 6 pin, 7 pin combination and pilot light, 7 pin miniature, 7 pin subminiature, octal, loctal, 9 pin miniature, blank.
Available tests:.....	Emission, short, leakage, open element, filament continuity.

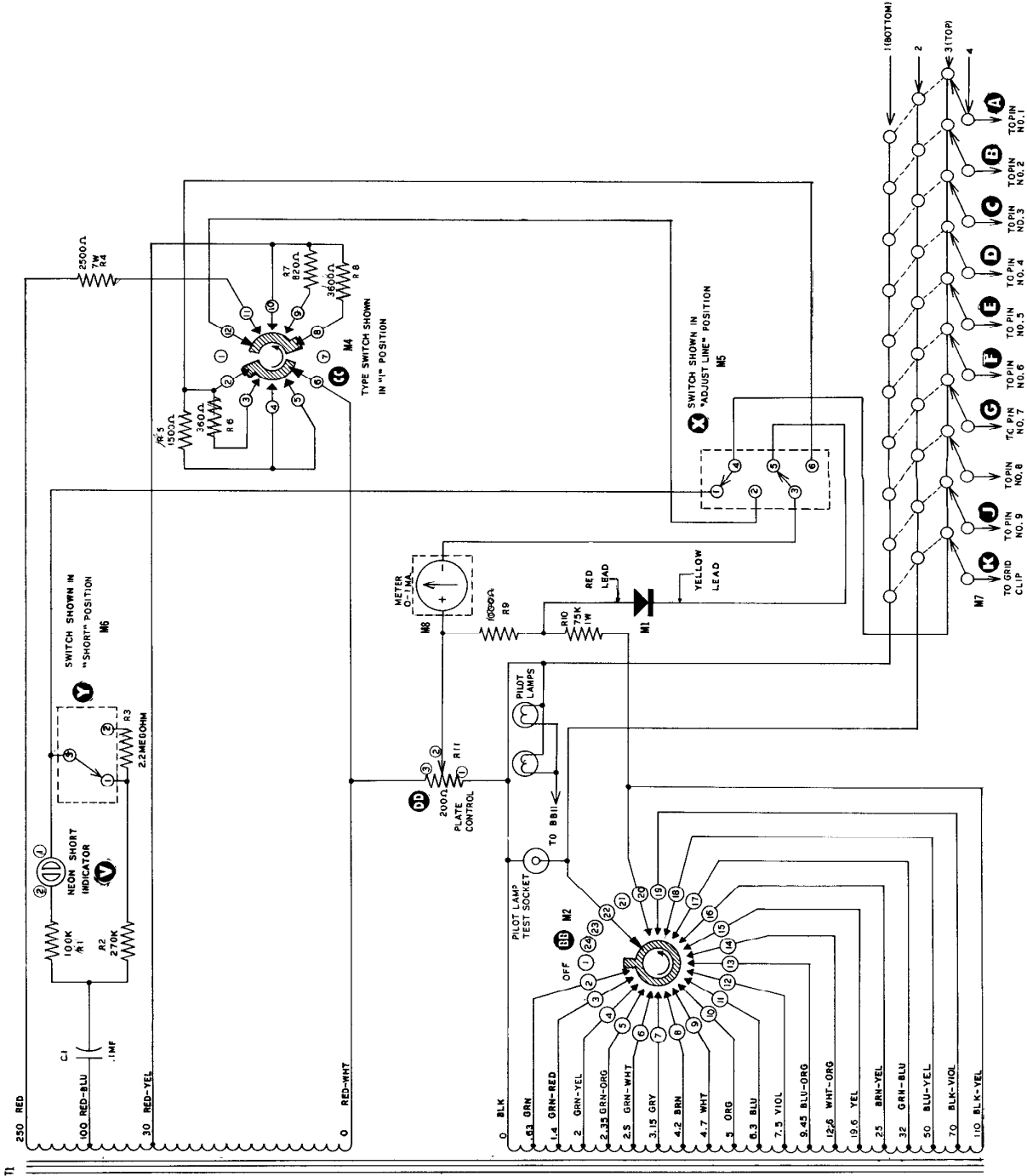

**SCHEMATIC
HEATHKIT TUBE CHECKER
MODEL TC-3**

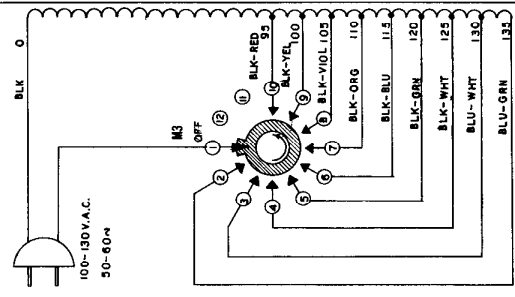

LINE AND FILAMENT SWITCHES
SHOWN IN "OFF" POSITION.

INTRODUCTION

A vacuum tube possesses a number of operating characteristics, any one of which may be used to indicate, to a limited degree, the operational capabilities of the tube. Any number of tube testing devices are available, utilizing one or more of these characteristics, each one subject to its own limitations. It is universally recognized that no tube tester can provide a complete and accurate account of the condition existing within a given vacuum tube when that tube is in operation in the receiver. If maximum benefit is to be obtained from a tube tester, regardless of its design, two things should be known:

- (1) the requirements placed on the tube
- (2) the limitations of the tube tester.

With this thought in mind, we have listed some of the more commonly used methods of tube testing.

EMISSION TESTING

Testing the emission capabilities of the cathode provides the simplest and most economical means of determining the overall quality of a vacuum tube. This is accomplished by connecting all the grids to the plate and operating the tube as a rectifier. The actual emission of the cathode is then compared to a predetermined value accepted as standard for that tube type. If the cathode should have one particularly active portion, the emission checker will indicate the quality of the tube to be good, even though the remainder of the cathode may be inactive. On the other hand, modern coated cathodes are capable of large emission, often far in excess of the emission required for the particular application. In some cases the emission checker will indicate the quality of the tube to be questionable or even unacceptable. This tube may not function in an application requiring a large emission but would probably operate satisfactorily for a long time in a circuit where the emission requirements are less.

TRANSCONDUCTANCE TESTING

A transconductance tester places a standard voltage on each tube element, creating a plate current flow. Measurement of this plate current will indicate the transconductance of that particular tube under static conditions. Here again, since the tube is not operating EXACTLY as it does in the receiver, the test may be termed inconclusive. An improved version of the transconductance test is available in:

DYNAMIC TRANSCONDUCTANCE TESTING

The dynamic transconductance of a tube is measured by using the circuit of the static transconductance tester and adding a signal generator. By applying a signal to the tube under test, the action of the plate current will be similar to that experienced in the receiver, varying in relationship to the input signal. Although this system gives an indication of how the tube will operate under signal conditions, it is still limited in scope. Certain types of tubes cannot be satisfactorily checked on any type of tester, even the dynamic transconductance tester. Particular offenders in this respect are tubes used in the vertical and horizontal deflection circuits of television receivers. The only method of accurately checking these tubes is by:

SET TESTING

No tube tester is required in this system of tube testing; simply insert a new tube in the receiver and observe the results. At first glance this appears to be the most inexpensive testing system available. Bear in mind, however, that if all tubes were to be tested in this manner, a stock of tubes representing an investment of several hundred dollars is required.

POWER OUTPUT TESTING

This testing system is perhaps the most satisfactory in regards to similarity between test results and actual operation in the receiver. Since both the input and output powers are known, the other factors can be determined. In the case of voltage amplifiers the voltage amplification and output voltage will be of prime interest. The power output test is ideally suited to testing power amplifiers, where the output power is of major concern.

LOW LINE TEST

In this testing system the input voltage to the receiver is lowered to 105 volts. Sufficient time should be allowed (10 minutes) for the tube heaters to stabilize. If the questionable tube fails to function properly it should be replaced.

INSTRUMENT DESCRIPTION

In designing a tube checker, the designer is faced with the problem of deciding which of the above mentioned testing procedures to follow. Points that must be considered are the cost, relative merits of each system, and the net value to the purchaser. On the basis of these and other considerations, the Heathkit Tube Checker has been designed around the emission testing circuit. There are several reasons for this decision, some of which are : (1) the emission checker will provide the best overall indication of tube quality when compared with other types on a cost per unit basis, (2) the transconductance of a tube is dependent upon cathode emission, (3) some busy service men do not wish to take the time necessary to check the tube thoroughly. They plug in the tube, push the button and observe the meter to check the emission; if the emission of the tube is too low for the intended service, determining any of the other characteristics is a waste of valuable time, (4) the emission testing circuit is relatively simple, requires few components, and lends itself well to kit-type construction, (5) the low selling price made possible by the use of this circuit more than compensates for any inherent shortcomings it may possess. We sincerely believe the Heathkit Tube Checker will give the most test information per dollar invested.

The action of the instrument has been made quite flexible by the use of multiple filament voltages, adjustable cathode current, variable meter sensitivity and individual element switching. The ten lever switches make it possible to connect any element to any other element, regardless of the pin numbers involved.

The instrument may be used in darkened areas (such as the inevitable dark corner behind the TV receiver) with ease since both the roll chart and the meter are illuminated.

No difficulty should be experienced in roll chart operation on the part of the left-handed operator. Thumbwheel drive knobs have been provided on both sides of the panel to eliminate any "cross-over" problems. The roll chart mechanism is a unique design which permits the roll chart to run freely throughout its entire length without binding. The chart rollers are spring loaded to keep the chart taut at all times to present a smooth viewing surface.

TUBE TYPE ACCOMMODATIONS

The Heathkit TC-3 Tube Checker was designed for checking tubes encountered in everyday radio and TV service work, but is not specifically limited to these types. It will check satisfactorily any tube that can be accommodated in the tube sockets if the data provided by the tube manufacturer is available. Sockets provided are: 4 pin, 5 pin, 6 pin, 7 pin combination, 7 pin miniature, 7 pin subminiature, octal, loctal, and 9 pin miniature. A blank socket is also provided to facilitate modification for checking newly added base types as protection against obsolescence.

ROLL CHART DATA

The roll chart contains necessary data for the checking of currently used tubes. Because of the constantly growing list of tubes it is impossible to list all the tubes on the chart. Many tubes not listed on the chart may be found in the roll chart supplement. The Heath Company periodically revises the roll chart to include the newly released tube types. Announcement of revised roll chart availability is usually made in the Heathkit Flyer.

FILAMENT VOLTAGES

Filament voltages used in the operation of the tube checker are derived from a secondary winding on the power transformer which is tapped to provide nineteen different voltages. These voltages are switch selected for convenience of operation and assure the application of the proper filament voltage for a given tube type under test.

TEST VOLTAGES

Voltages used in the various tests provided by the TC-3 are derived from a secondary winding on the power transformer which is tapped at 30, 100, and 250 volts. During the operation of the checker, three basic circuits are set up using these voltages.

LINE TEST CIRCUIT

The first basic circuit is in use when the TEST switch is in the SET LINE position. The SET LINE switch in the primary of the power transformer varies the voltage across the primary, thus controlling the voltage across both secondary windings simultaneously. The meter, with the voltage divider and rectifier network now in the circuit, will indicate the proper secondary voltage when the needle is within the LINE TEST block. The purpose of the SET LINE switch is to assure proper voltages on the tube under test, thus minimizing the possibility of an erroneous indication due to abnormally high (or low) power line voltages

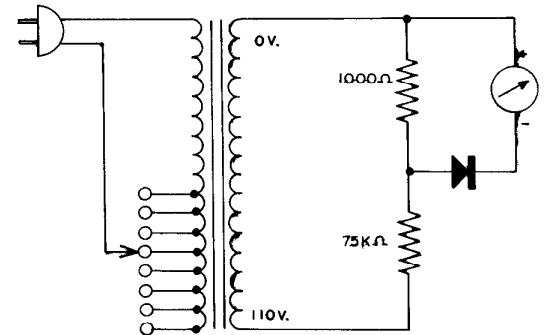

LINE TEST CIRCUIT

Illustration 1

SHORT TEST CIRCUIT

The second basic circuit is used in the short, leakage, and filament continuity tests. The 100 volt tap is connected to the neon short indicator and associated network and is in series with the plate of the tube under test. The meter is not in the circuit; the tests are indicated by the neon bulb. Moving the lever switches in the prescribed manner connects the tube elements in such a manner that a shorted element will cause considerable increased current flow through the resistor in parallel with the neon bulb. The voltage drop then produced reaches the operating voltage of the neon bulb causing it to glow, thus indicating a short. For the leakage test, the circuit remains unchanged in all respects except one: the value of the resistance in parallel with the neon bulb is increased, thus increasing the sensitivity of the test. The term short as used in this test should not be confused with the direct short formed by connecting two terminals with a piece of wire. The sensitivity rating of the short test is 250 KΩ, which means the bulb will glow if the resistance between the shorted elements is anywhere between the values of 0 and 250,000 ohms. The sensitivity rating of the leakage test (high-sensitivity short test) is 2 megohms, which means that the bulb will glow if the resistance between the shorted elements is anywhere between 0 and 2,000,000 ohms. Actually, this test may be altered to any desired sen-

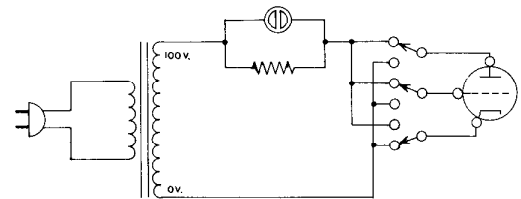

Illustration 2

sitivity by replacing the 2.2 megohm resistor with the required value. The short test is a very critical test and should be performed carefully and evaluated in terms of the amount of leakage which can be tolerated in the circuit.

QUALITY TEST CIRCUIT

The third basic circuit is used when making the quality and open element tests. The plate and grids are connected together to the 30 volt transformer tap. The filament and cathode are connected together to the 0 volt tap of the high voltage winding through the PLATE control. The plate control adjusts the sensitivity of the meter, which is in the circuit at this time. The tube now conducts as a half-wave rectifier, the total emission of the cathode being passed to a single terminal (anode) and out through the meter circuit.

A good tube, with the sensitivity of the meter properly adjusted, will have sufficient cathode emission to swing the meter needle into the GOOD section of the scale. If the emission is too low, the current through the tube will not be high enough to bring the needle into the GOOD section; it will remain in the (?) section or drop into the BAD section.

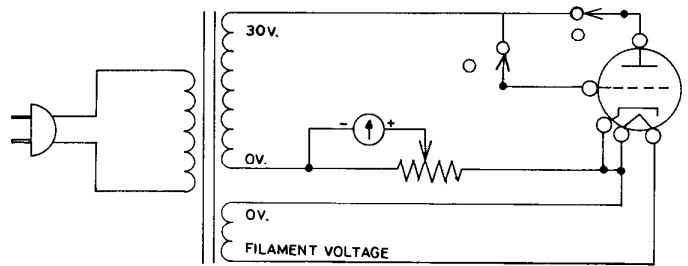

QUALITY TEST CIRCUIT

Illustration 3

An open element may be detected in the following manner. Since all tube elements (except cathode) are connected to the plate terminal, the current indicated by the meter during the quality test represents the total current through the tube. Disconnecting an element from the plate terminal will cause the current through the tube to diminish. The meter reading will then be less than originally noted. Therefore, a drop in the meter reading indicates the element is not open. If the element were open, disconnecting it from the plate terminal would make no change in the tube current, hence no change in the meter reading. For tubes with a number of grids, the operation is somewhat more complex, but the same theory applies in general. For gas tubes (OZ4, etc.) the 250 volt tap is used instead of the 30 volt tap. The rest of the circuitry remains unchanged.

NOTES ON ASSEMBLY AND WIRING

The Heathkit Model TC-3 Tube Checker, when properly constructed, will provide a service type instrument capable of many years of satisfactory operation. We urge you to take the necessary time to assemble and wire the instrument carefully. Do not hurry the work and you will be rewarded with a greater sense of confidence both in the instrument and your own workmanship.

This manual is supplied to assist you in completing the instrument with the least possible chance of error. We suggest that you take a few minutes now and scan through the entire manual carefully before any work is started. This will enable you to proceed with the work much faster and with greater accuracy. The large fold-in pictorials are handy to attach to the wall above your work space. Their use will greatly simplify the construction of the kit. These diagrams are repeated in smaller form within the manual. We suggest that you retain the manual in your files for future reference, both in the use and maintenance of the TC-3 Tube Checker.

Unpack the kit carefully and check each part against the parts list. By so doing, you will become acquainted with each part. Refer to the charts and other information shown in the manual, to help you identify any parts about which there may be a question. If some shortage is found in checking the parts, please notify us promptly and return the inspection slip with your letter to us.

Leads on resistors and capacitors are generally much longer than they need to be to make the

indicated connections. The excess lead length should be cut off before the part is added to the circuit. In general, the leads should be just long enough to reach their terminating points.

The pictorials indicate actual chassis wiring and designate values of the component parts. We very strongly urge that the chassis layout and lead placement be followed exactly as shown. While the arrangement shown is probably not the only satisfactory layout, it is the result of considerable experimentation and trial. By following the pictorials of lead and component placement carefully, neat appearance and dependable operation are assured.

Space has been provided for you to check off each operation as it is completed. This is particularly important in wiring and it may prevent omissions or errors, especially where your work is interrupted frequently as the wiring progresses. When interrupted, it is often helpful to review the preceding two or three steps before continuing with the assembly. Some kit builders have also found it helpful to mark each lead in colored pencil on the pictorial as it is added.

Resistors and controls generally have a tolerance rating of $\pm 20\%$ unless otherwise stated in the parts list. Therefore a $100\text{ K}\Omega$ resistor may test anywhere from $80\text{ K}\Omega$ to $120\text{ K}\Omega$. (The letter K is commonly used to designate a multiplier of one thousand.) The parts furnished with your Heathkit have been specified to provide optimum performance of the finished instrument.

In order to expedite delivery to you, we are occasionally forced to make minor substitutions of parts. Such substitutions are carefully checked before they are approved to insure that the parts supplied will work satisfactorily. By checking the parts list for resistors, for example, you may find that a 2 megohm resistor has been supplied in place of a 2.2 megohm as shown in the parts list. These changes are self-evident and are mentioned here only to prevent confusion to you in checking the contents of your kit.

PROPER SOLDERING PROCEDURE

Only a small percentage of Heathkit purchasers find it necessary to return an instrument for factory service. Of these kits, by far the largest proportion function improperly due to poor or improper soldering.

Correct soldering technique is extremely important. Good solder joints are essential if the performance engineered into the kit is to be fully realized.

Read the notes on soldering and wiring on the inside rear cover. If terminals are bright and clean and wires free of wax, frayed insulation and other foreign substances, no difficulty will be experienced in soldering. Crimp or otherwise secure the wire (or wires) to the terminal, so a good joint is made without relying on solder for physical strength. To make a good solder

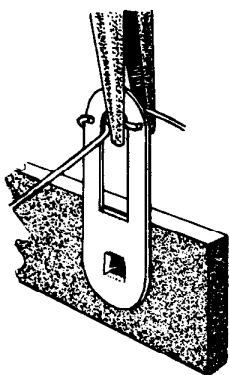

CRIMP WIRES

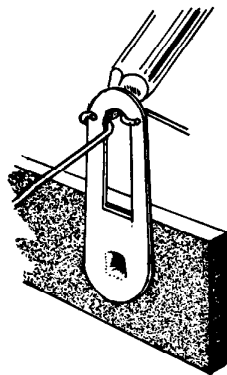

HEAT CONNECTION

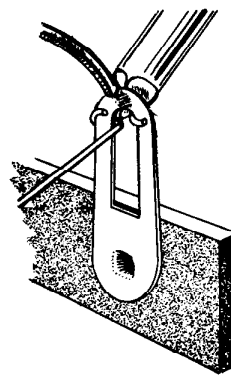

APPLY SOLDER

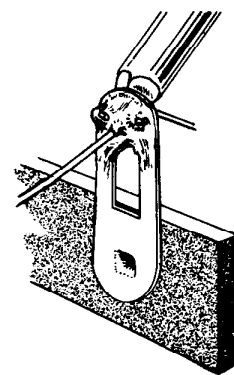

ALLOW SOLDER
TO FLOW

joint, the clean tip of the soldering iron should be placed against the joint to be soldered so that the terminal is heated sufficiently to melt the solder. The solder is then placed against both the terminal and tip of the iron and will immediately flow out over the joint. Refer to the sketch shown on page 7. Use only enough solder to cover wires at the junction; it is not necessary to fill the entire hole in the terminal with solder. Excess solder may flow into tube socket contacts, ruining the socket, or it may creep into switch contacts and destroy their spring action. Position the work so that gravity tends to keep the solder where you want it.

A poor solder joint will usually be indicated by its appearance. The solder will stand up in a blob on top of the connection, with no evidence of flowing out caused by actual "wetting" of the contact. A crystalline or grainy texture on the solder surface, caused by movement of the joint before it solidified is another evidence of a "cold" connection. In either event, reheat the joint until the solder flows smoothly over the entire junction, cooling to a smooth, bright appearance. The following illustration clearly indicates these two characteristics.

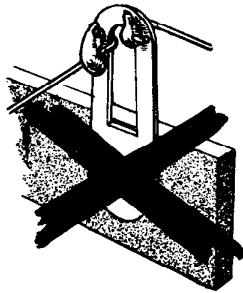

**COLD SOLDER JOINT
CONNECTION INSUFFICIENTLY
HEATED**

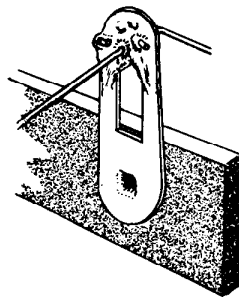

**PROPER SOLDER
CONNECTION**

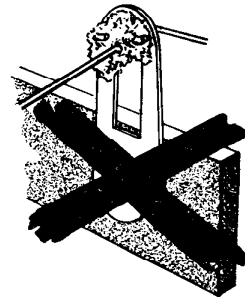

**COLD SOLDER JOINT
CONNECTION MOVED
WHILE COOLING**

A good, clean, well-tinned soldering iron is also important to obtain consistently perfect connections. For most wiring, a 30 to 100 watt iron, or the equivalent in a soldering gun, is very satisfactory. Small irons generally will not heat the connections enough to flow the solder smoothly over the joint and are recommended only for light work, such as on etched circuit boards, etc. Keep the iron tip clean and bright. A clean rag may be used to wipe the tip occasionally during use.

Take these precautions and use reasonable care during assembly of the kit. This will insure the wonderful satisfaction of having the instrument operate perfectly the first time it is turned on.

STEP-BY-STEP ASSEMBLY INSTRUCTIONS

Study Pictorial 1 carefully and note the placement of the various parts. This pictorial shows the aluminum panel as viewed from the rear. Throughout this manual a system of alphabetical designation will be used for each part, and each terminal connection of the part will be assigned a number. Therefore, the first tube socket in the upper left corner, which is the local socket, is designated as L, and the eight pin connections will be identified as L1, L2, L3, etc. Actually marking the panel openings will prove helpful. This same procedure will be used throughout the entire instrument construction. Please note also that some parts have been assigned a dual alphabetical designation, such as AA, BB, CC, etc.

Actual assembly will first begin with the mounting of the ten tube sockets. All of these sockets are of the ring mounting type to provide a neat panel appearance. See Figure 1. When installing these sockets with the mounting ring, be sure to make the installation properly so that no difficulty with socket loosening will occur later on after the wiring has been installed. When installing sockets, note the keyway positioning carefully. This is very important, as a misaligned keyway may cause incorrect wiring. Note that in some cases each pin of the socket has a molded number for quick identification.

An additional wavy ring and lock ring have been provided for your convenience in the event a ring should become damaged during construction. Please note that one of the wavy rings is much larger than the rest; this ring is to be used on the large 7 pin socket having the pilot light socket incorporated in its design.

To prevent marring the finish of the Tube Checker panel, it is advisable to place a pad or cloth over the workbench or working surface.

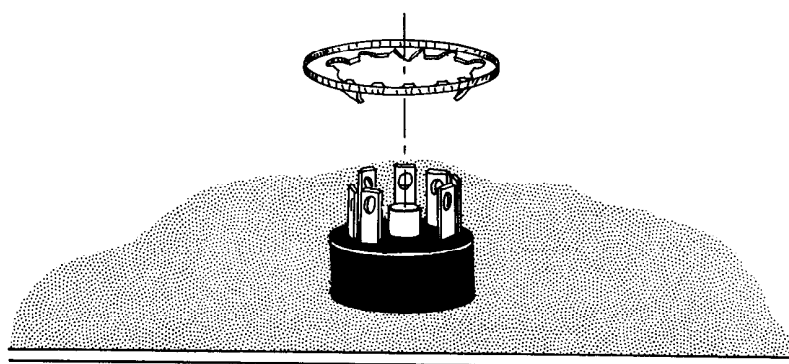
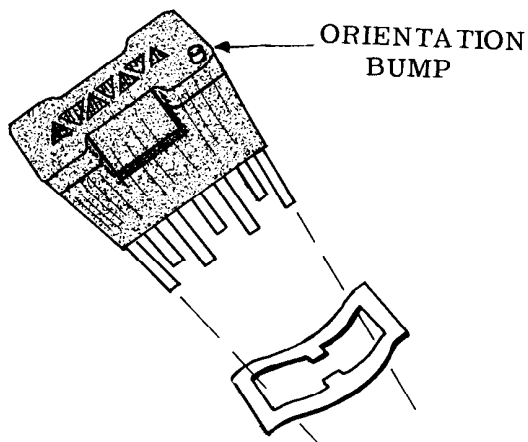
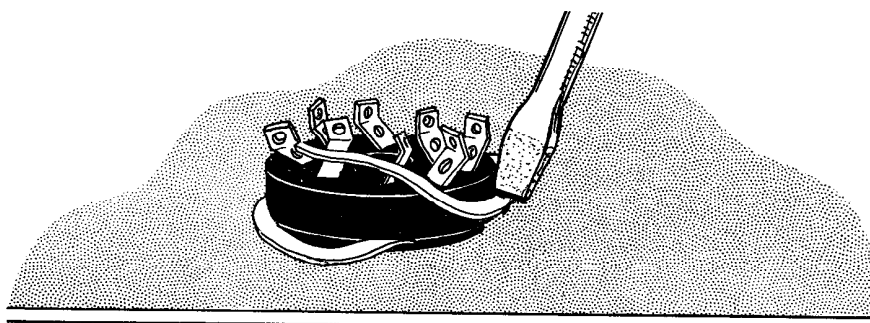

METHOD OF INSTALLING TUBE SOCKETS

Figure 1

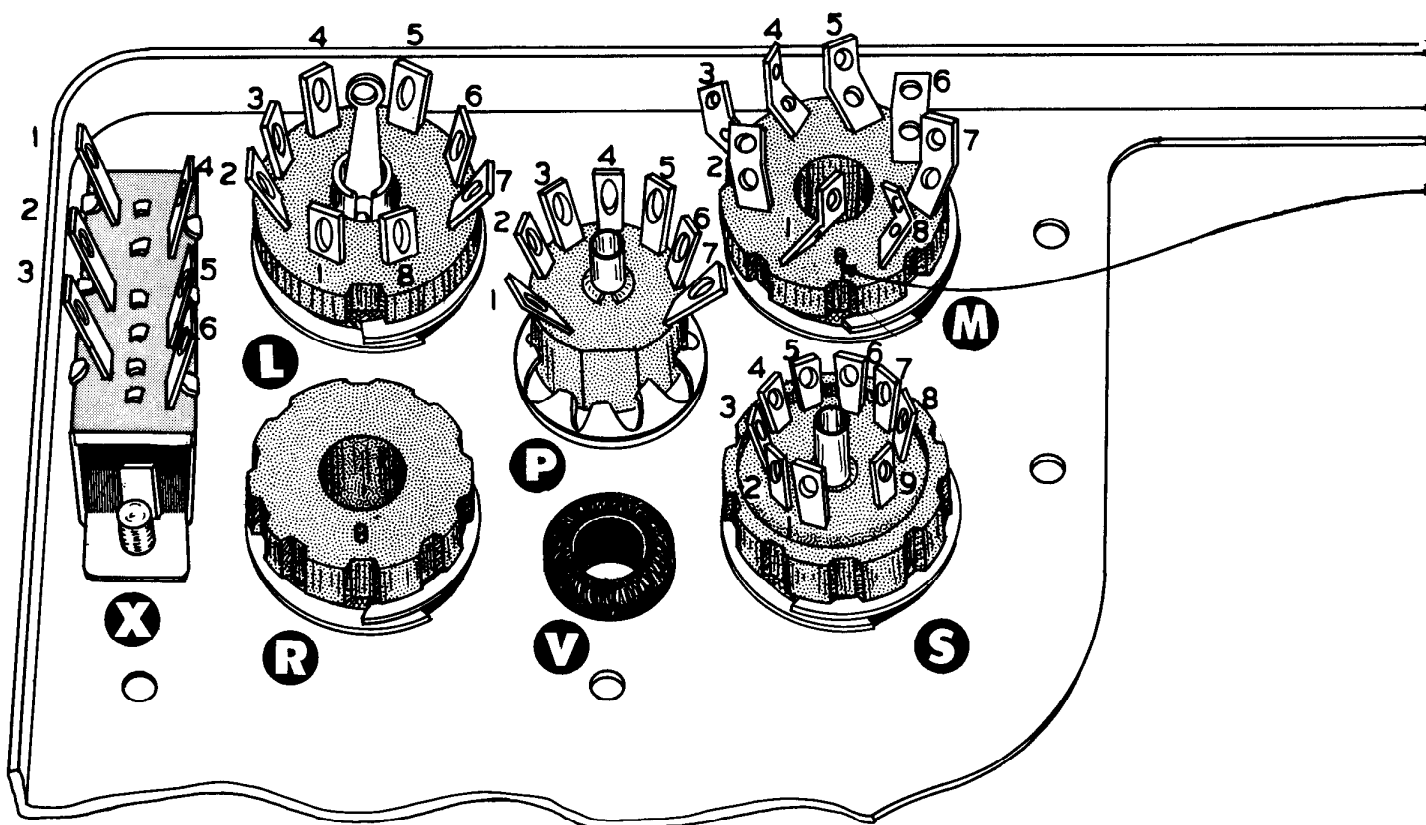

- () Mount the 7 pin miniature socket in location P. Note placement of the flat on the side of the socket. The socket is held in place by a lock ring, which is pressed over the base of the socket after it has been properly placed in the panel. In the event the lock ring fits too tightly for installation, bend the teeth slightly with a pair of long-nose pliers.
- () Mount the loctal socket in location L, using the wavy ring mounting method previously described. Note keyway placement.
- () Mount the octal socket in location M. Note keyway placement.
- () Mount the blank socket in location R.
- () Mount the 9 pin miniature socket in location S. Note that the blank space is placed toward the bottom of the panel.
- () Mount the DPDT spring return slide switch in location X. When mounting the switch orient it so that the slide button is normally in the SHORT-ADJUST LINE position (see front of panel). Use 6-32 screws. No lockwashers or nuts are needed as the switch frame is tapped to receive the screws.
- () Insert a 1/2" rubber grommet in location V.

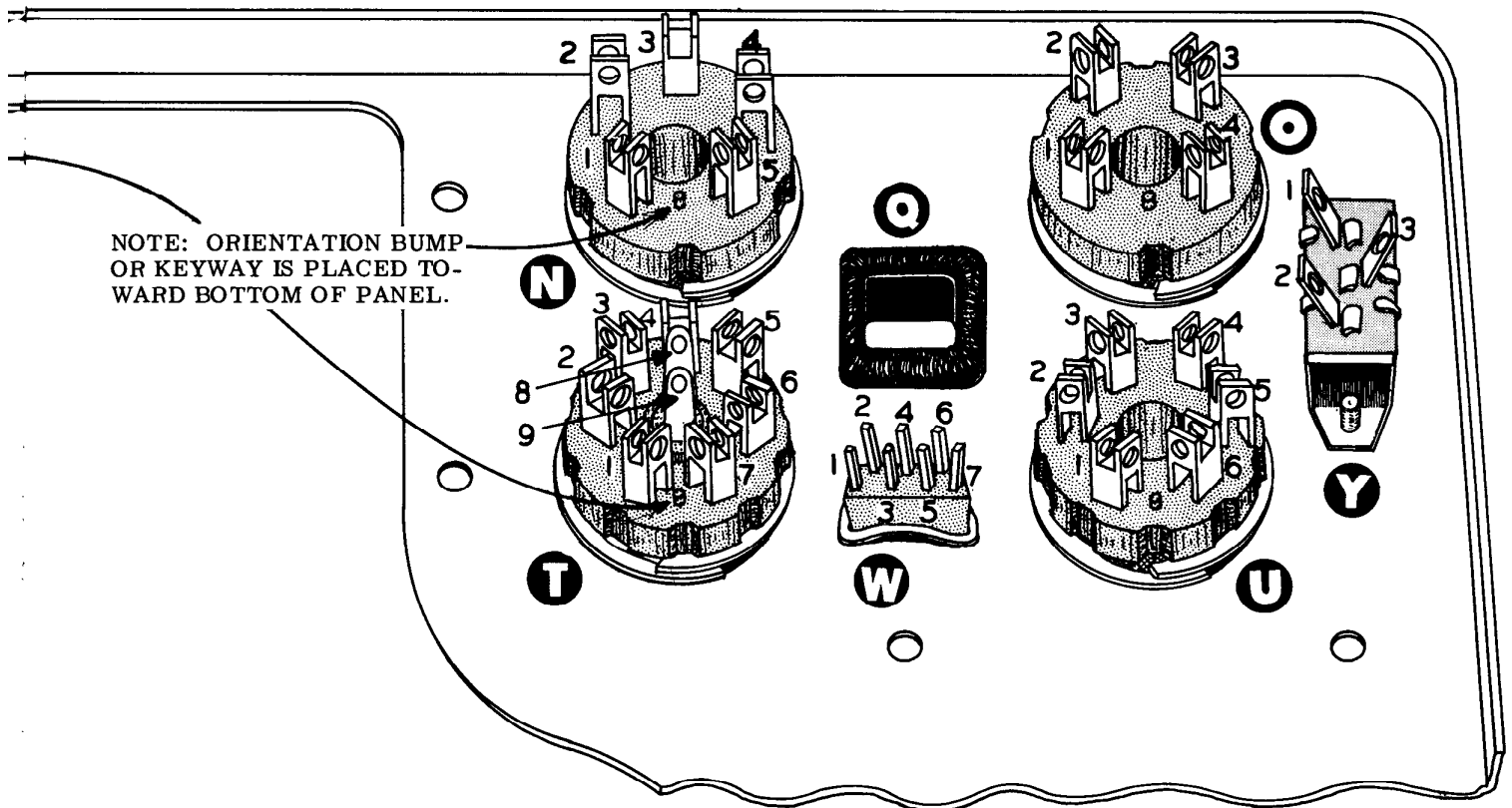

- () Mount the 7 pin subminiature socket in location W. Place the orientation bump toward the center of the panel adjacent to the white dot. Push the retaining ring down firmly to hold the socket securely against the panel. See Figure 1 on page 9.
- () Mount the 5 pin socket in location N.
- () Mount the 4 pin socket in location O.
- () Mount the large 7 pin socket in location T. This socket uses the largest of the wavy rings supplied.
- () Mount the 6 pin socket in location U.
- () Using 6-32 screws, mount the SHORT-LEAKAGE switch in location Y. Position the lugs as shown in Pictorial 1.
- () Insert a 3/4" rubber grommet in location Q. Work the grommet carefully into the corners until a uniformly square appearance is obtained.

The mechanical assembly of the Tube Checker is interrupted at this point in order to partially wire the tube sockets before the chassis is installed. Before proceeding with the socket wiring, however, re-check carefully all assembly up to this point. In the event any errors are present, it is much easier to correct them before the wiring is in place.

In order to simplify the detailed and important wiring between the tube sockets and lever switches, color coded wire will be used. A four foot length of 8-wire color-coded cable has been furnished with this kit. Two lengths of this cable will be required for two separate wiring harnesses.

Measure and cut off a 15" length of 8-wire cable and a 10" length of 8-wire cable. Separate the remaining length of cable by cutting a portion of the outer plastic insulation and removing the wires one at a time. DO NOT separate the 15" and 10" lengths of cable previously cut. You should now have:

- 1 15" length of 8-wire cable
- 1 10" length of 8-wire cable
- 8 lengths (approximately 29") of color coded wire (one each of brown, red, orange, yellow, green, blue, white and black).

The color code used for resistor identification will be followed as closely as possible, with the exception of the white and black wires. The code used for all socket wiring in this kit will be:

- | | |
|-----------|----------|
| 1. Brown | 5. Green |
| 2. Red | 6. Blue |
| 3. Orange | 7. White |
| 4. Yellow | 8. Black |

All No. 1 socket terminals will therefore be connected with brown wire, all No. 2 socket terminals with red wire, etc.

Since the wire used in connecting the tube socket terminals is a stranded wire, it will be necessary to solder the fine wires together before connecting the lead to the terminal. In each step measure the amount of wire needed to perform the operation, trim off 1/4" of the plastic insulation from the ends and tin with a hot soldering iron. Allow the solder to flow freely into the strands to provide a good bond between the individual wires. Perform the operation as quickly as possible to prevent damage to the plastic insulation.

(S) means solder. (NS) means DO NOT solder yet.

The number associated with soldering instructions denotes the number of wires tied to that particular point at the time of soldering.

Example: (S-1) means there should be one wire connected to the soldered terminal.

(S-2) means there should be two wires connected to the soldered terminal, etc.

Dress all leads as shown in the pictorial diagrams.

Using appropriate wire lengths of the color indicated, make the following connections:

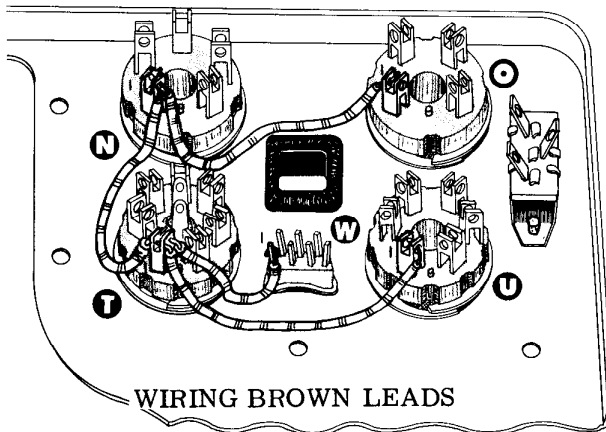

Using brown wire, connect leads from:

- () T1 (NS) to W1 (S-1)

(Bend the terminals on socket W outward to provide more space for making the connections. Crimp the lead tightly around the terminal before soldering.)

- () T1 (NS) to U1 (S-1)
- () T1 (NS) to N1 (NS)
- () N1 (S-2) to O1 (S-1)

Using red wire, connect leads from:

- () T2 (NS) to W2 (S-1)
- () T2 (NS) to U2 (S-1)
- () T2 (NS) to N2 (NS)
- () N2 (S-2) to O2 (S-1)

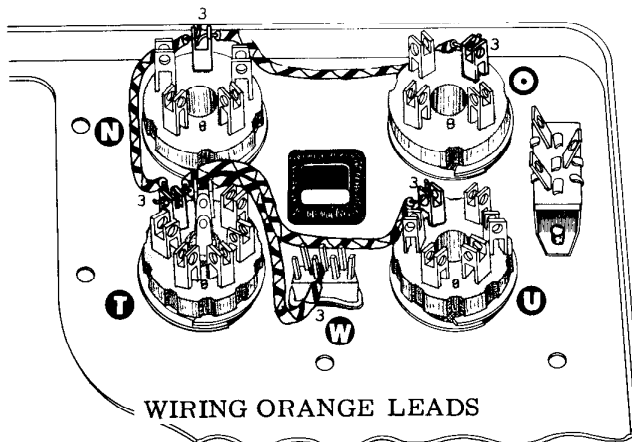
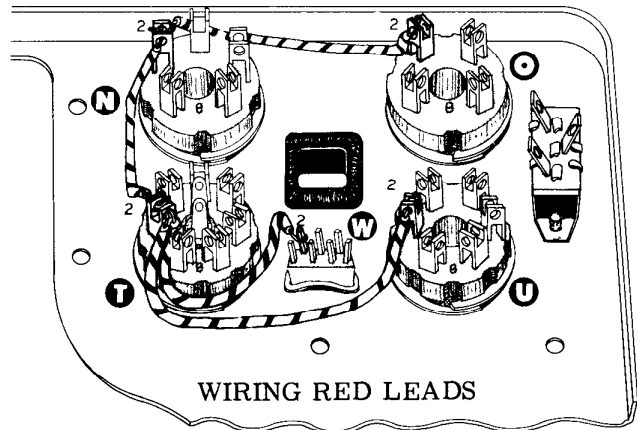

Using orange wire, connect leads from:

- () T3 (NS) to W3 (S-1)
- () T3 (NS) to U3 (S-1)
- () T3 (NS) to N3 (NS)
- () N3 (S-2) to O3 (S-1)

Using yellow wire, connect leads from:

- () T4 (NS) to W4 (S-1)
- () T4 (NS) to U4 (S-1)
- () T4 (NS) to N4 (NS)
- () N4 (S-2) to O4 (S-1)

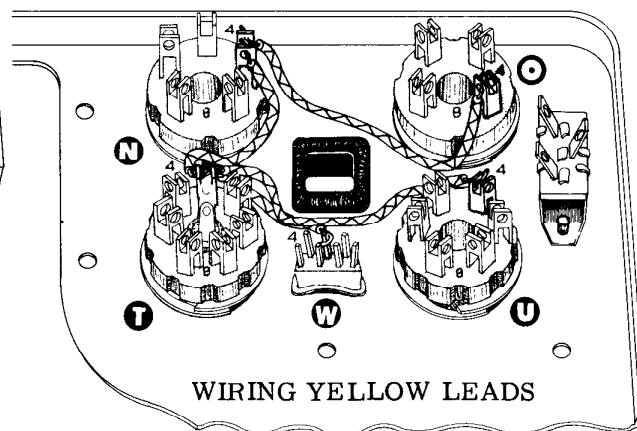

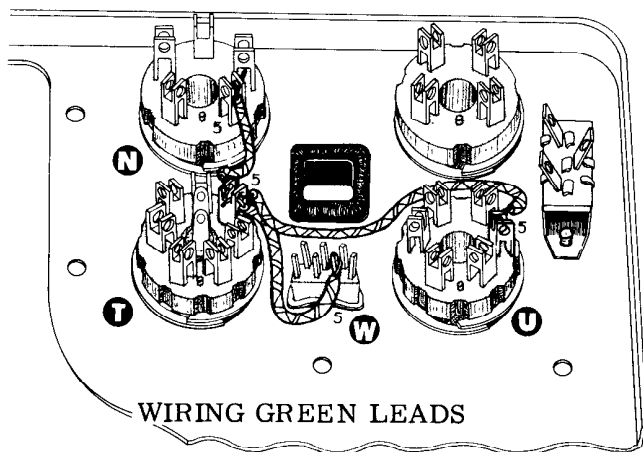

Using green wire, connect leads from:

- () T5 (NS) to W5 (S-1)
- () T5 (NS) to U5 (S-1)
- () T5 (NS) to N5 (S-1)

Using blue wire, connect leads from:

- () T6 (NS) to W6 (S-1)
- () T6 (NS) to U6 (S-1)

Using white wire, connect a lead from:

- () T7 (NS) to W7 (S-1)

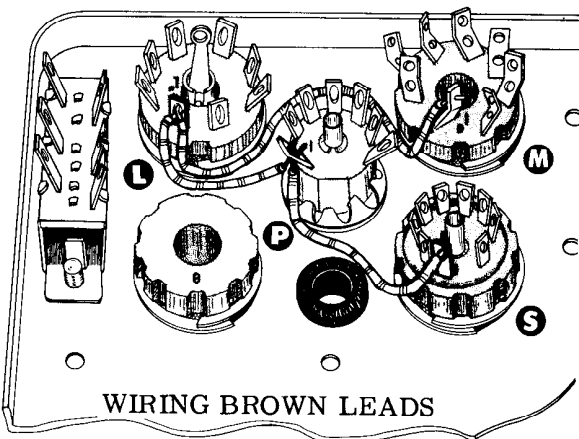
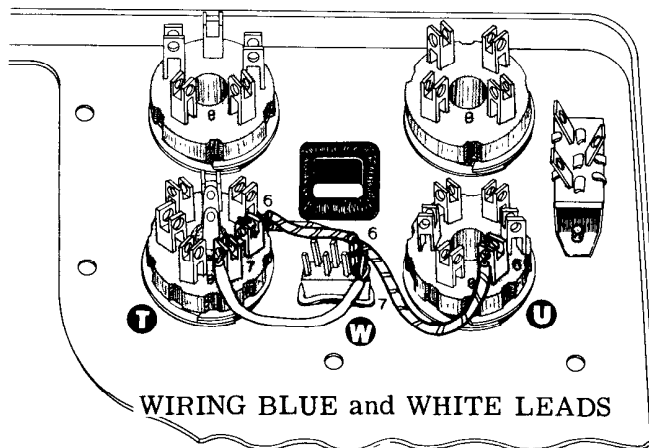

Using brown wire, connect leads from:

- () S1 (S-1) to P1 (NS)
- (Bend the terminals on socket P outward to provide more space for making the connections.)
- () P1 (S-2) to L1 (NS)
 - () L1 (NS) to M1 (NS)

Using red wire, connect leads from:

- () S2 (S-1) to P2 (NS)
- () P2 (S-2) to L2 (NS)
- () L2 (NS) to M2 (NS)

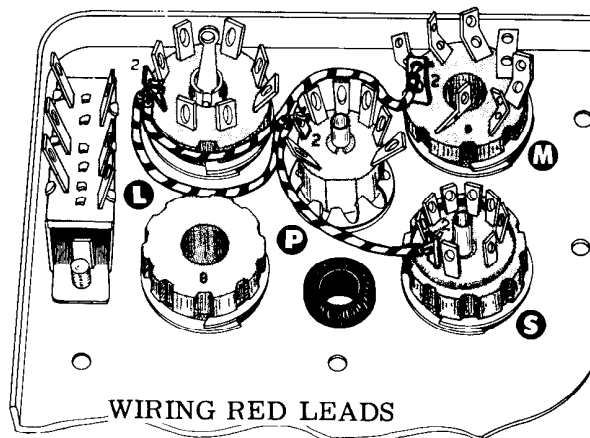

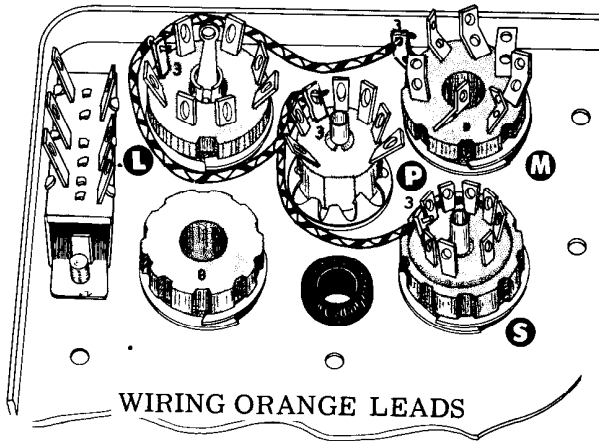

Using orange wire, connect leads from:

- () S3 (S-1) to P3 (NS)
- () P3 (S-2) to L3 (NS)
- () L3 (NS) to M3 (NS)

Using yellow wire, connect leads from:

- () S4 (S-1) to P4 (NS)
- () P4 (S-2) to L4 (NS)
- () L4 (NS) to M4 (NS)

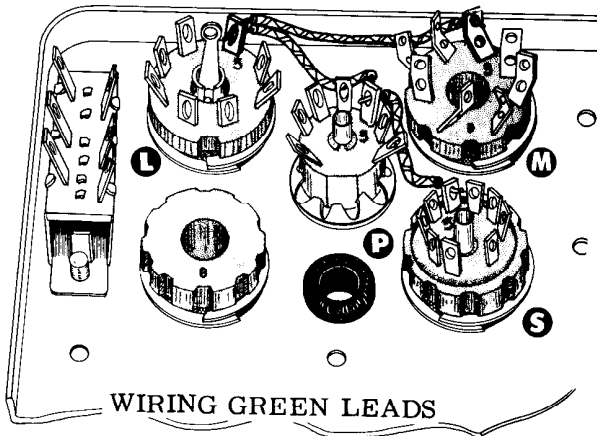
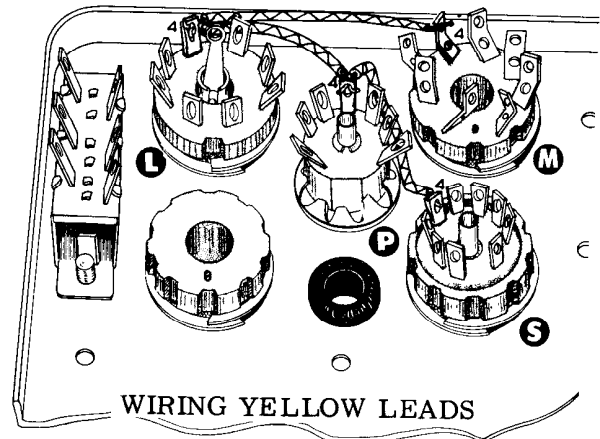

Using green wire, connect leads from:

- () S5 (S-1) to P5 (NS)
- () P5 (S-2) to L5 (NS)
- () L5 (NS) to M5 (NS)

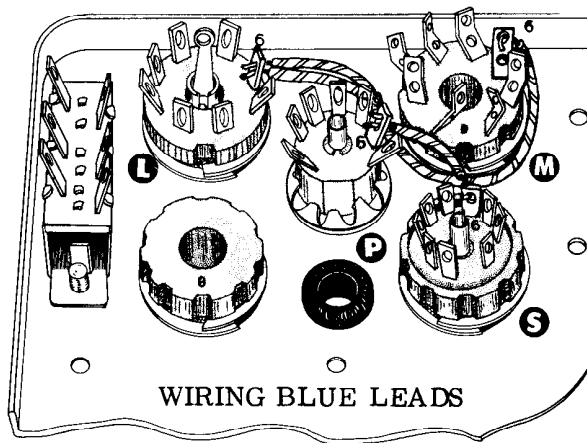

Using blue wire, connect leads from:

- () S6 (S-1) to P6 (NS)
- () P6 (S-2) to L6 (NS)
- () L6 (NS) to M6 (NS)

Using white wire, connect leads from:

- () S7 (S-1) to P7 (NS)
- () P7 (S-2) to L7 (NS)
- () L7 (NS) to M7 (NS)

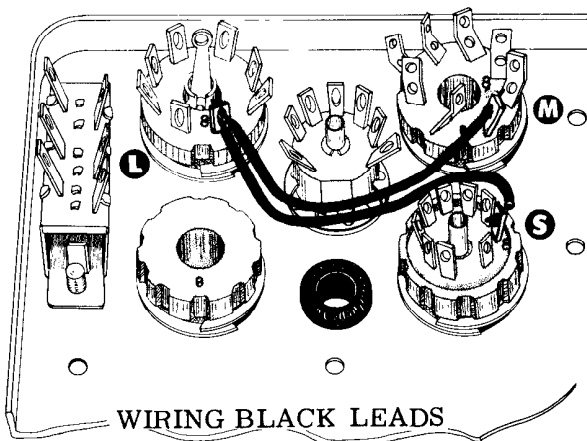
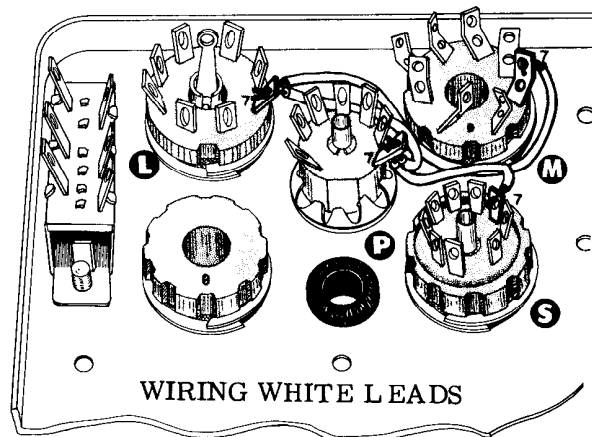

Using black wire, connect leads from:

- () S8 (S-1) to L8 (NS)
- () L8 (NS) to M8 (S-1)

This completes the preliminary tube socket wiring.

- () Select the 10-gang lever switch assembly and examine it carefully. You will notice that on each switch, one lug is longer than the other three and will contact the rotor blade at all times regardless of the position of the lever. This is the "common" lug and is designated as lug number 4. When installing the lever switch assembly on the panel these "common" lugs should be at the bottom of the panel as shown in Figure 2. Slide the panel insert into the panel and hold it in place by mounting the lever switch assembly. Use 4-40 screws. Before tightening the four mounting screws, line up the holes near the top of the panel with the corresponding holes in the panel insert. Place a 6-32 screw through the hole between letters E and F on the panel and secure with lockwasher and nut.

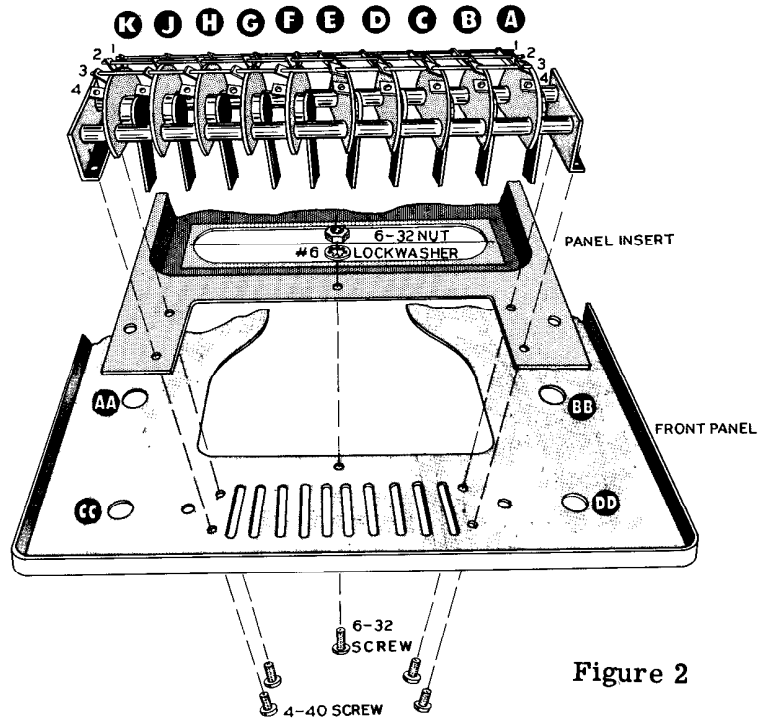
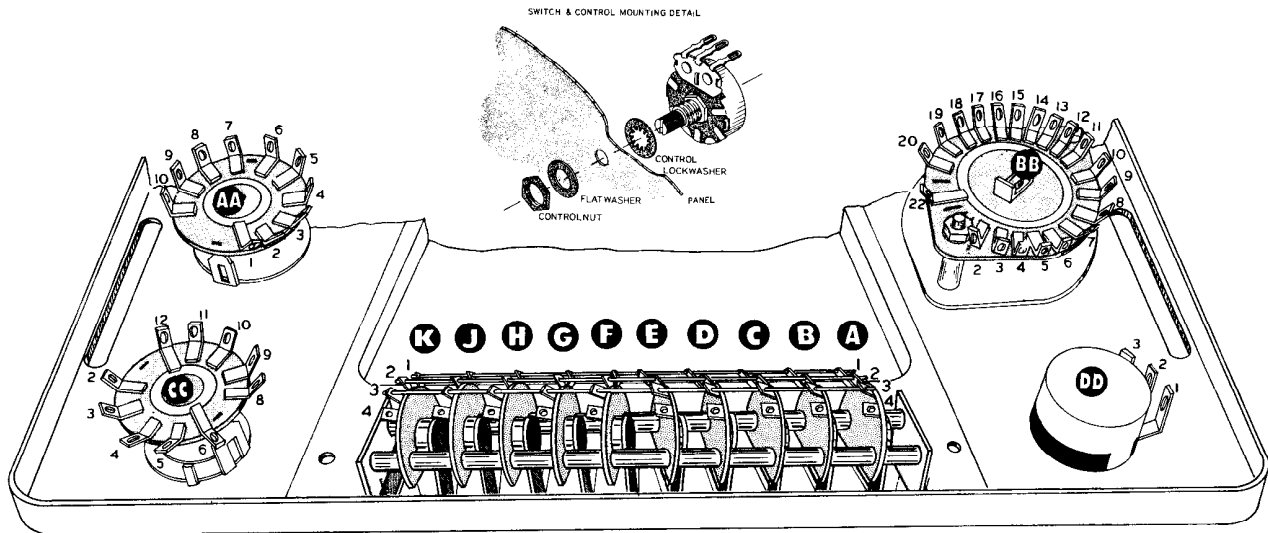

Figure 2

- () Straighten the length of bare wire and slide it through all the No. 1 switch terminals. Cut the wire to the proper length, allowing about 1/16" to extend beyond the switch at either end of the gang. See Figure 2.
- () Repeat the preceding step, this time sliding the wire through the No. 2 switch terminals.



PICTORIAL 2

- () Slide the remaining length of bare wire through the No. 3 switch terminals, and cut to length.
- () Solder terminals 1, 2, and 3 on switches B, C, D, E, F, G, H and J. DO NOT solder any terminals on switches A and K at the ends of the gang. When soldering the terminals, be sure to use a hot iron and flow the solder smoothly and quickly into each joint so that a good electrical connection will result. Avoid the use of an excessive amount of solder.

CHASSIS AND METER MOUNTING

- () Insert the meter into the meter mounting plate as shown in Figure 3. Be sure the bottom of the meter is adjacent to the two large holes in the mounting plate. Do not turn down the nuts on the meter mounting studs yet as some adjustments may be required later. Do not use the lockwashers.
- () Referring to Figure 4, place the meter into the panel insert. Line up the four holes in the meter mounting plate with the corresponding holes in the panel and panel insert. Viewing the meter from the front of the panel will indicate the proper position. Now tighten the nuts on the meter studs to a "snug" fit. Drawing these nuts down too tightly may cause cracking of the plastic meter case. Now remove the meter and mounting plate assembly.

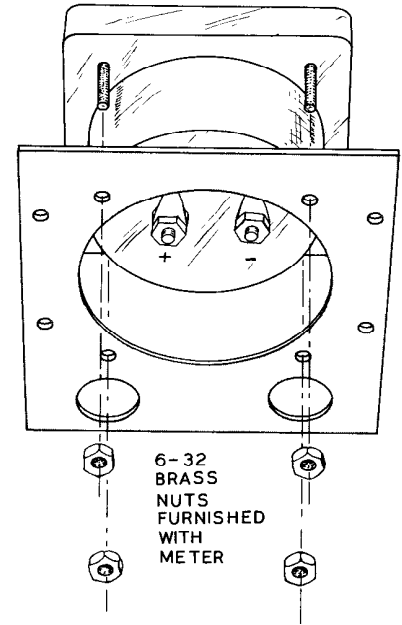

Figure 3

- () Using 6-32 screws, lockwashers and nuts, mount the chassis on the panel. Refer to Figure 5 and Pictorial 3.

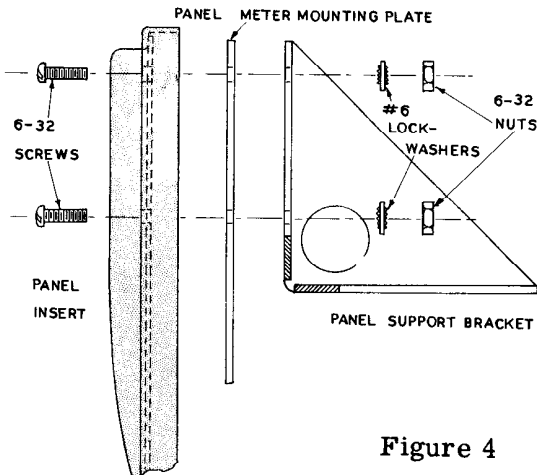

Figure 4

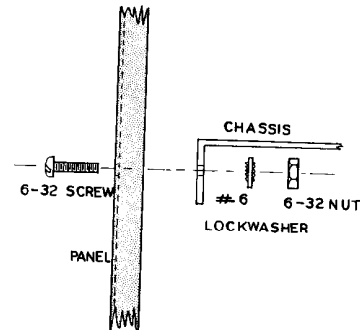
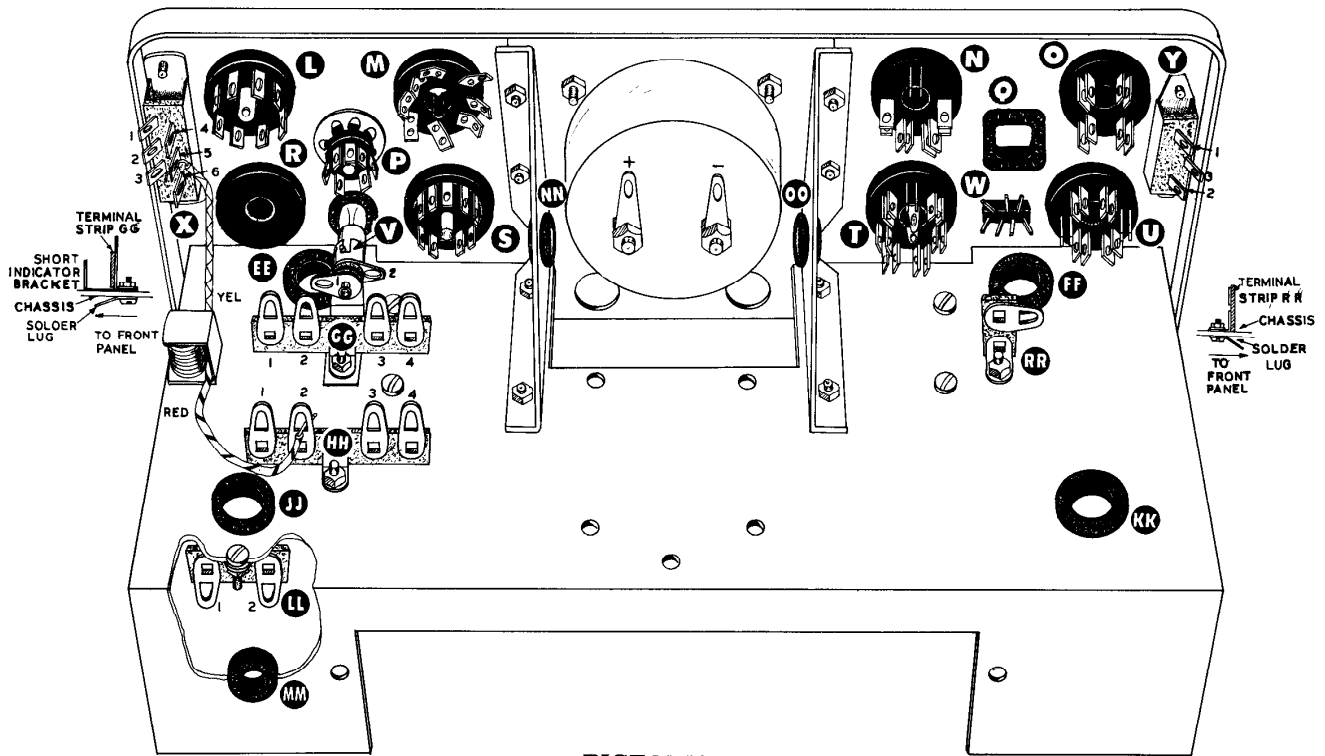

Figure 5

- () Slide the meter and mounting plate assembly into the panel insert and hold it in place temporarily with one 6-32 screw and nut through the hole adjacent to the top of the panel and the octal socket.
- () Install a panel support bracket adjacent to the large 7 pin socket. Use 6-32 screws, lockwashers and nuts. Tighten the screws closest to the corner of the bracket first, alternately turning each one about 1/8 of a turn. In this way the bracket will be pulled slowly toward the junction of the panel and the chassis to provide a good fit at both surfaces and prevent bending of the panel by a misaligned bracket. When both screws have been securely tightened, turn the remaining two screws down tight.
- () Remove the nut from the screw on the other side of the meter and install the other panel support bracket as outlined in the preceding step.



PICTORIAL 3

Refer to Pictorial 3 for placement of the grommets in the following steps.

- () Slide a 3/4" rubber grommet in location EE.
- () Slide a 3/4" rubber grommet in location FF.
- () Slide a 3/4" rubber grommet in location JJ.
- () Slide a 3/4" rubber grommet in location KK.
- () Slide a 3/8" rubber grommet in location MM.
- () Slide a 3/4" rubber grommet in location NN.
- () Slide a 3/4" rubber grommet in location OO.

- () Insert the neon bulb short indicator in the pilot light socket with the mounting bracket. Push the bulb through grommet V in the panel until the mounting hole in the bracket lines up with the corresponding hole in the chassis. See Figure 6.

- () Mount the 4-lug terminal strip GG, installing the solder lug under the chassis as shown. Pass the screw through the chassis, through the light socket bracket and terminal strip mounting lug.

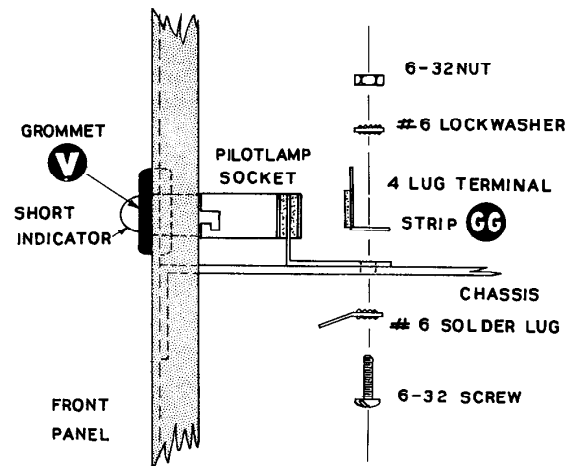
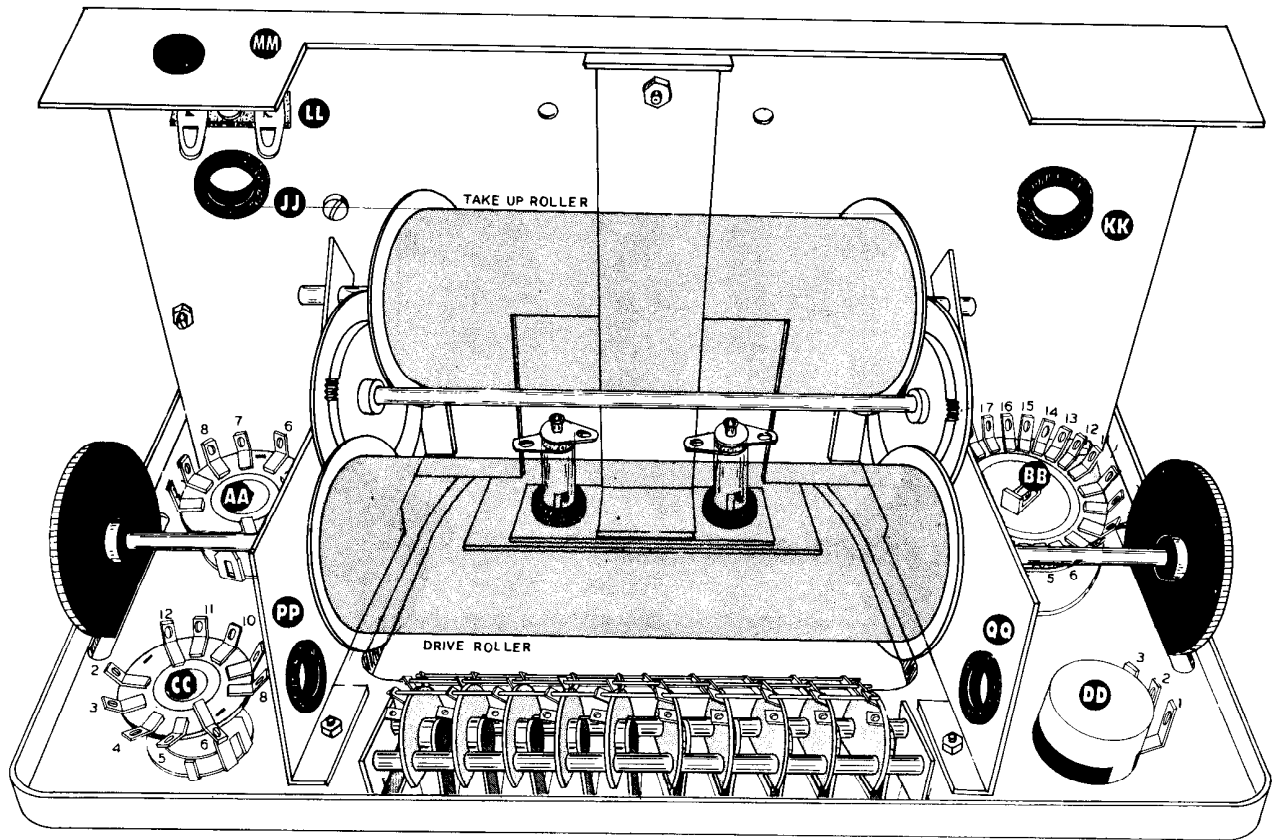

Figure 6

- () Mount the 4-lug terminal strip HH.

- () Mount the meter rectifier using a #6 lockwasher and 6-32 nut. See Pictorial 3.

- () Mount the 2-lug terminal strip LL. Position the terminal strip as shown in Pictorials 3 and 4.
- () Mount the 1-lug terminal strip RR, installing the solder lug under the chassis as shown.



PICTORIAL 4

ROLL CHART ASSEMBLY

Refer to Figure 7 in the construction of the roll chart assembly. The two rollers supplied with the kit are identical in every respect except shaft length. The roller with the longer shaft is the drive roller. The roller with the shorter shaft is the take-up roller.

- () Assemble the idler gears and shaft by sliding a gear on the shaft at either end. The gear on the knurled end should completely cover the knurling. Note that the gear teeth face toward the center of the shaft and the gear backing plate faces toward the end of the shaft. The spacing between the idler gears is obtained by laying it alongside one of the rollers and moving the adjustable gear until the idler gear teeth mesh with the roller gear teeth.

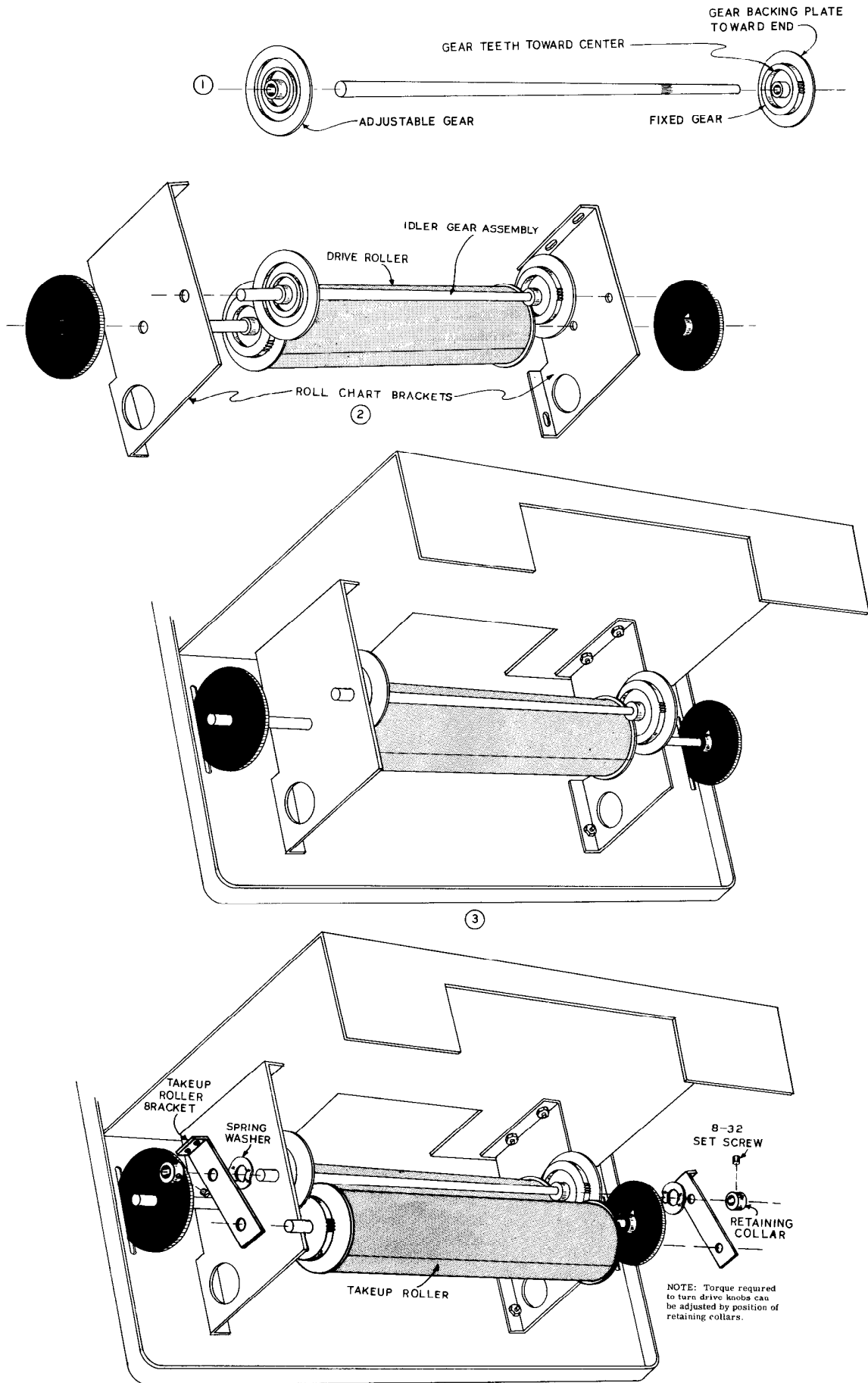

④
Figure 7

- () Assemble the drive roller and idler gear assembly by sliding the end brackets into place. Be sure the gears are properly meshed at BOTH ENDS before installing the end brackets.
- () Slide a thumbwheel drive knob on each end of the drive shaft (hub towards end bracket).
- () Install the chart mechanism using 6-32 hardware. Start the nuts on all three screws in each bracket, then turn each a fraction of a turn, alternating as in the case of the panel support brackets.
- () Place the take-up roller on the end brackets as shown in step 4 of Figure 7, and roll it toward the chassis. The gears at both ends should mesh with the idler gears while the shaft maintains contact with the end bracket.
- () Install the spring washers, take-up roller brackets and retaining collars (use 8-32 x 1/8" setscrews).
- () Center the thumbwheel drive knobs in their respective slots and secure with 8-32 x 1/4" setscrews. The chart mechanism should run smoothly without any "side sway".

This completes the assembly of the roll chart mechanism. When you have the mechanism running smoothly, put ONE DROP of light machine oil on each bearing surface. If the gears bind or the rollers have a tendency to slide from side to side, re-check the positioning of the idler gears, retaining collars and brackets.

- () Insert a 3/4" rubber grommet in location PP.
- () Insert a 3/4" rubber grommet in location QQ.
- () Mount the 20 position FILAMENT switch in location BB, using a control lockwasher, flat washer and nut. Position the switch as shown in Pictorial 5.
- () Mount the 200 Ω PLATE control in location DD. Use a control lockwasher, flat washer and nut.
- () Mount the 10 position LINE switch in location AA. Position the switch as shown in Pictorial 5.
- () Mount the 4 position TYPE switch in location CC. Position the switch so that the flat on the switch shaft is toward the bottom of the panel. See Pictorial 5 for terminal orientation.

Refer to Pictorials 5 and 6 for the following wiring steps.

- () Connect the 360 Ω 1/2 watt resistor (orange-blue-brown) from CC2 (NS) to CC3 (S-1).
- () Connect the 1500 Ω 1/2 watt resistor (brown-green-red) from CC2 (NS) through CC4 (S-1) to CC5 (S-1).
- () Connect the 820 Ω 1/2 watt resistor (gray-red-brown) from CC9 (S-1) to CC10 (NS).
- () Connect the 3600 Ω 1/2 watt resistor (orange-blue-red) from CC8 (S-1) to CC10 (NS).

NOTE: Wherever hookup wire is called for, proceed in the following manner. Cut the wire to the length specified. (Some leads may appear to be longer than necessary, but should not be shortened. The extra length is provided in case of future maintenance requirements.) Strip off 1/4" of the insulation from each end, and connect the bare lead to the proper terminal. Be sure to dress all leads as shown in the pictorials.

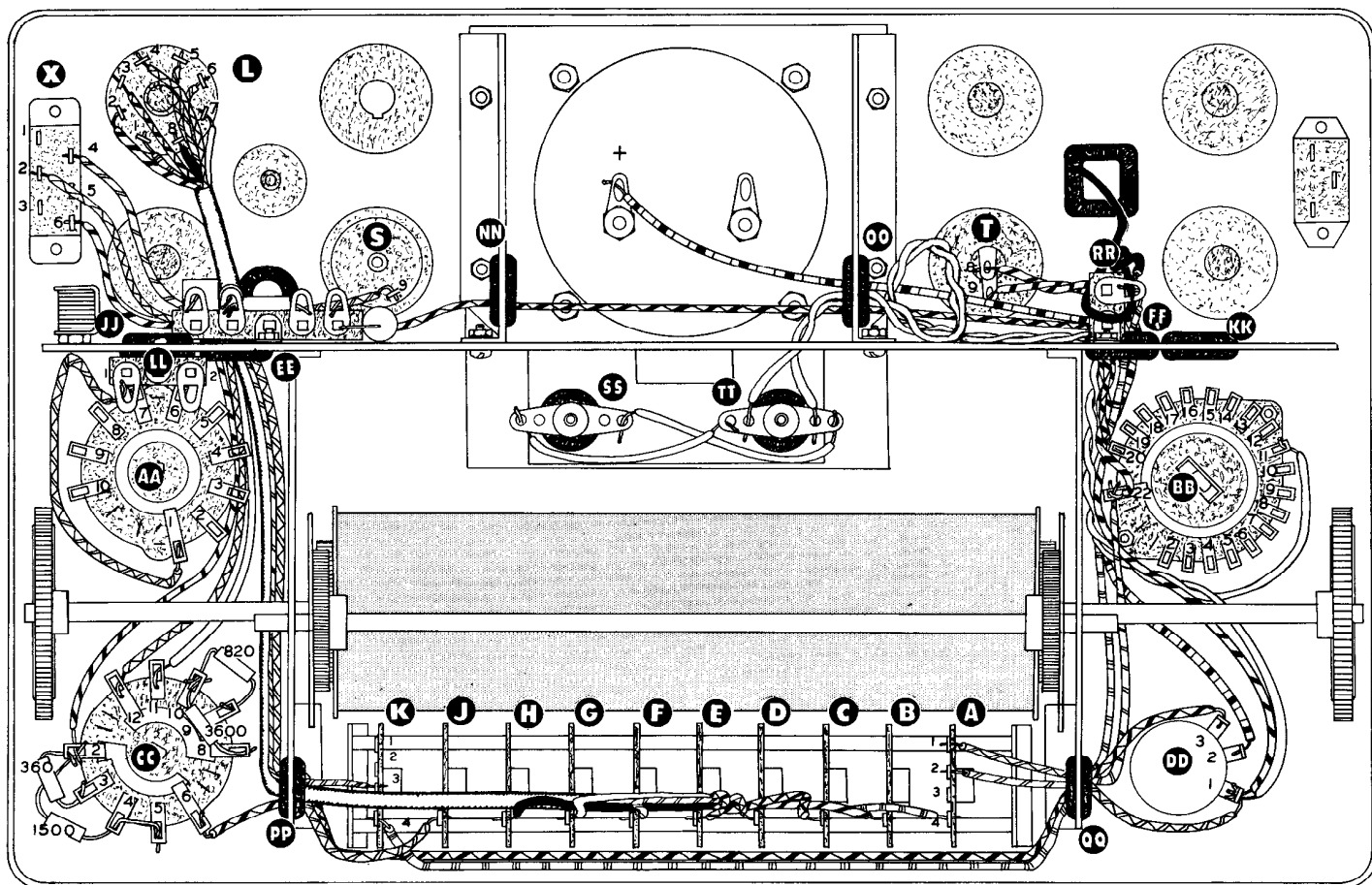

PICTORIAL 5

- () Connect an 8 1/2" length of hookup wire from CC2 (S-3) to X6 (S-1). Pass the lead through grommet EE and dress around other components as shown in Pictorial 5.
- () Connect an 8 1/2" length of hookup wire from CC12 (S-1) to X2 (S-1). Dress the lead as shown in Pictorial 5.
- () Connect a 12 1/4" length of hookup wire from CC6 (NS) to DD3 (S-1). Pass the lead through grommets PP and QQ and dress around the lever switch assembly as shown in Pictorial 5.
- () Connect a 6 1/4" length of hookup wire from CC11 (S-1) to GG1 (NS). Pass the lead through grommet EE. See Pictorials 3 and 5.
- () Connect a 5" length of hookup wire from A1 (S-2) to DD1 (NS).
- () Connect a 6 1/4" length of hookup wire from A2 (S-2) to BB22 (NS).
- () Connect a 10 1/2" length of hookup wire from K3 (S-2) to X4 (S-1).
- () Solder terminals A3, K1 and K2.
- () Connect a 15" length of hookup wire to K4 (S-1). Dress the lead around the lever switch assembly, through grommets QQ and FF to the top of the chassis. Connect the other end of the lead to terminal strip RR (NS).
- () Connect a 9 1/2" length of hookup wire from J4 (S-1) to S9 (S-1).

- () Prepare the 15" length of 8-wire cable as shown in Figure 8A. Cut all the leads to the length indicated (some leads are not cut off as their entire length will be used), strip off 1/4" of the plastic insulation from each lead and carefully twist and tin the exposed wires.
- () Pull the lever switch end of the cable carefully through grommet PP. Dress the cable under switch CC as shown in Pictorial 5. Pass the tube socket end of the cable through grommet EE toward socket L.

- () At the lever switch end of the cable connect the brown wire to A4 (S-1).
- () Connect the red wire to B4 (S-1).
- () Connect the orange wire to C4 (S-1).
- () Connect the yellow wire to D4 (S-1).

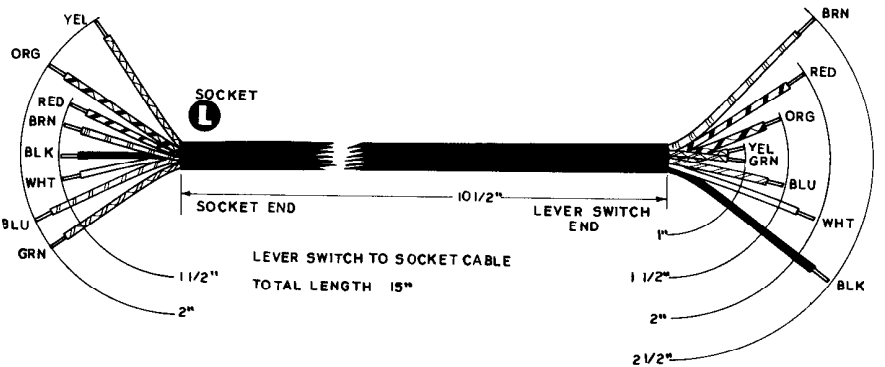

Figure 8A

- () Connect the green wire to E4 (S-1).
- () Connect the blue wire to F4 (S-1).
- () Connect the white wire to G4 (S-1).
- () Connect the black wire to H4 (S-1).
- () At the tube socket end of the cable connect the brown wire to L1 (S-3).
- () Connect the red wire to L2 (S-3).
- () Connect the orange wire to L3 (S-3).
- () Connect the yellow wire to L4 (S-3).
- () Connect the green wire to L5 (S-3).
- () Connect the black wire to L8 (S-3).
- () Connect the white wire to L7 (S-3).

- () Connect the blue wire to L6 (S-3).

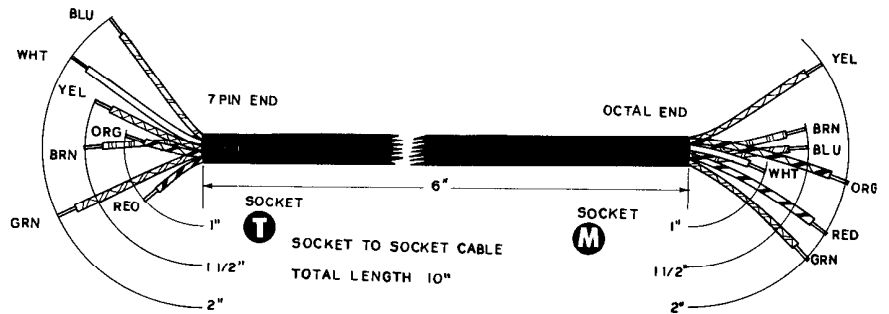

Figure 8B

- () Prepare the 10" length of cable as shown in Figure 8B. Again trim all leads to the proper length, strip and tin. Note that the black wire has been completely removed from the cable.
- () Pass the cable through grommet NN, across the back of the meter and through grommet OO. Be sure the end of the cable marked "Socket M" in Figure 8 is connected to the octal socket. See Pictorial 6 on page 26.
- () At socket M, connect the brown wire to M1 (S-2).
- () Connect the red wire to M2 (S-2).

- () Connect the orange wire to M3(S-2).
- () Connect the yellow wire to M4 (S-2).
- () Connect the green wire to M5 (S-2).
- () Connect the blue wire to M6 (S-2).
- () Connect the white wire to M7 (S-2).
- () At socket T, connect the brown wire to T1 (S-4).
- () Connect the red wire to T2 (S-4).
- () Connect the orange wire to T3 (S-4).
- () Connect the white wire to T7 (S-2).
- () Connect the blue wire to T6 (S-3).
- () Connect the green wire to T5 (S-4).
- () Connect the yellow wire to T4 (S-4).

You have now completed all of the wiring between the tube sockets and lever switches which will permit individual selection of any tube element. It is very important that this wiring be correctly done. We suggest that at this time you re-check all connections to the various tube socket terminals to make sure that no loose strands of wire, cuttings, or drops of solder can cause a short circuit. Dress all the wiring neatly away from each socket terminal and press the wiring toward the panel. To carry the test further, the use of an ohmmeter between terminal 4 of each lever switch and the corresponding socket terminals will indicate proper continuity. In a similar manner, short circuits between lever switch terminals, or socket terminals, or even grounding to the panel can be detected. The importance of correctly installing this wiring cannot be over-emphasized.

Refer to Pictorial 5 on page 23 and Pictorial 6 on page 26, for the following steps.

- () Connect the .1 mfd condenser from GG4 (NS) to HH4 (NS).
- () Connect the 100 K Ω 1/2 watt resistor (brown-black-yellow) from GG4 (NS) to V2 (S-1).
- () Connect the 270 K Ω 1/2 watt resistor (red-violet-yellow) from GG4 (S-3) to GG3 (NS).
- () Connect the 1000 Ω 1/2 watt resistor (brown-black-red) from HH2 (NS) to HH3 (NS).
- () Connect the 75 K Ω 1 watt precision resistor from HH2 (NS) to GG2 (NS).
- () Connect the red rectifier lead to HH2 (S-3).
- () Connect the yellow rectifier lead to X5 (S-1).
- () Connect the 2500 Ω 7 watt resistor from HH1 (NS) to GG1 (S-2).
- () Connect a 14 1/2" length of hookup wire from V1 (NS) to Y3 (S-1). Pass the lead through grommet NN, around the back of the meter, and through grommet OO to switch Y.
- () Connect a 4 3/4" length of hookup wire from V1 (S-2) to X1 (S-1).

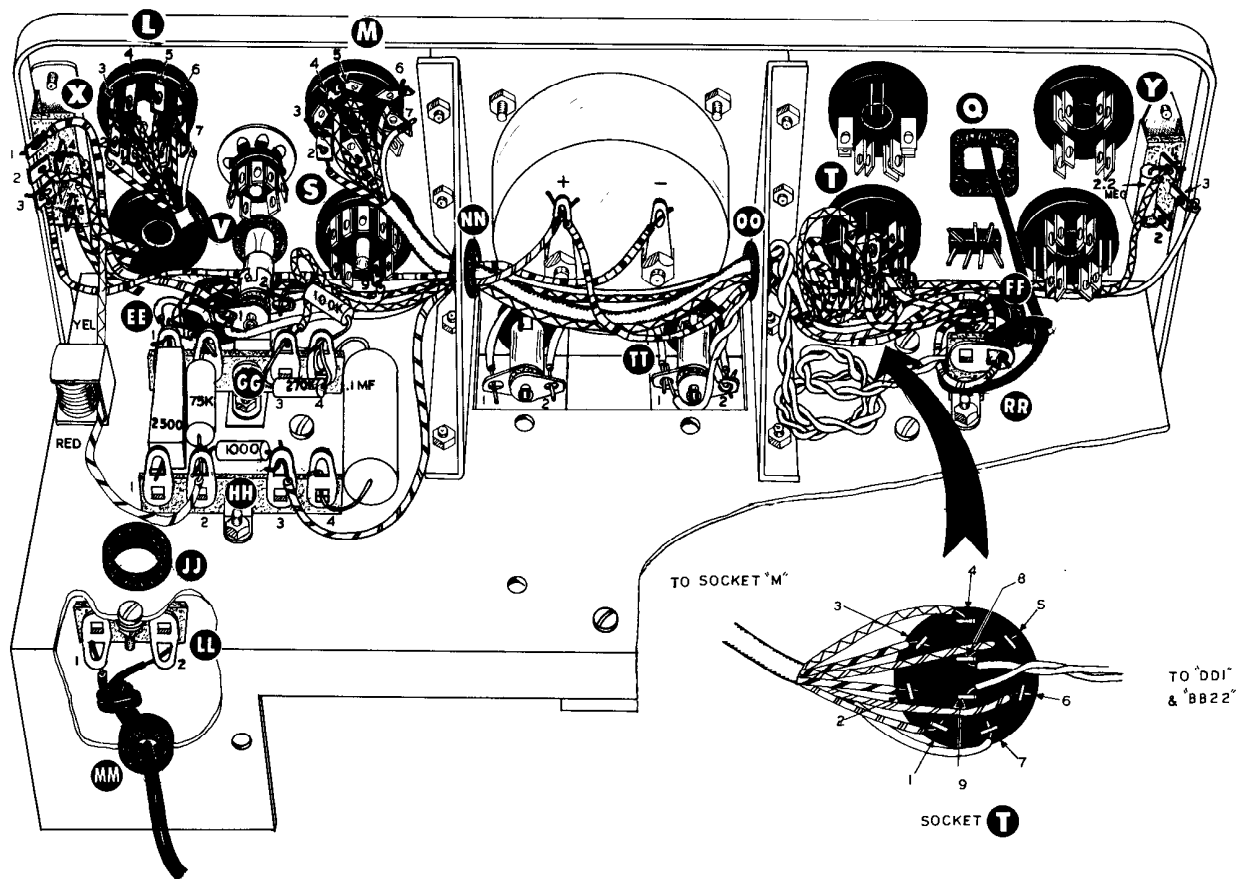

PICTORIAL 6

- () Connect a 14 1/2" length of hookup wire from GG3 (S-2) to Y1 (NS).
- () Connect the 2.2 megohm 1/2 watt resistor (red-red-green) from Y1 (S-2) to Y2 (S-1).
- () Connect a 10" length of hookup wire from X3 (S-1) to the negative terminal of the meter (S-1). The negative meter terminal is the terminal on the right when viewed from the rear of the panel. Pass the lead through grommet NN.
- () Connect a 13 1/2" length of hookup wire from GG2 (S-2) to BB20 (NS). Pass the lead through grommet NN, around the back of the meter and through grommets OO and FF to switch BB.
- () Connect a 7 1/4" length of hookup wire from HH3 (S-2) to the positive meter terminal (NS). Pass the lead through grommet NN.
- () Connect a 12" length of hookup wire from the positive meter terminal (S-2) to DD2 (S-1). Pass the lead through grommets OO and FF.
- () Connect an 8 1/2" length of hookup wire from LL1 (NS) to AA1 (S-1).
- () Cut two 8" lengths of hookup wire and twist together about 4" at one end. Pass the ends of the pair that are not twisted together through grommet FF and connect one lead to DD1 (NS) and the other to BB22 (S-2). At the other end of the pair connect one lead to T8 (S-1) and the other to T9 (S-1).

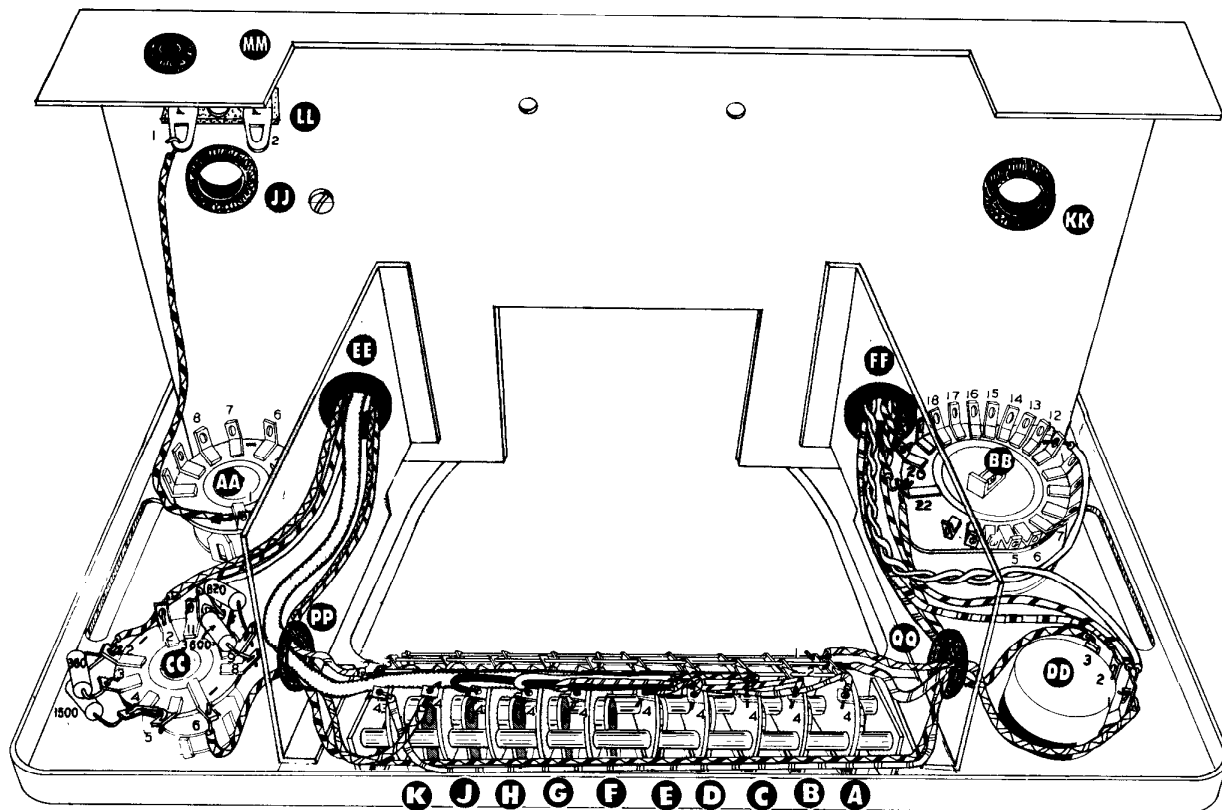

PICTORIAL 7

() Insert 1/2" rubber grommets in holes SS and TT in the panel lamp mounting bracket. See Figure 9.

() Install the two #47 pilot lamp bulbs in the pilot lamp sockets and push the bulbs through the rubber grommets until the end of the bulb is 9/16" from the outer surface of the bracket. It is important to measure this distance carefully so that the bulb will not be in contact with the panel. See Figure 9.

() Cut two 4" lengths of hookup wire. Connect the terminals of the lamp sockets by running one wire from SS1 (S-1) to TT1 (NS). Connect the other wire from SS2 (S-1) to TT2 (NS).

() The panel lamp connecting cable is made from the remaining length of hookup wire (approximately 36"). Cut the wire in two and twist the two pieces together to form a 2-wire cable.

() At one end of the cable connect one wire to TT1 (S-2) and the other to TT2 (S-2).

() Pass the other end of the cable up through the chassis opening beneath the meter and through grommet OO, while sliding the panel lamp bracket into place. See Pictorial 5. The grommets holding the panel lamps should fit completely into the holes in the meter mounting

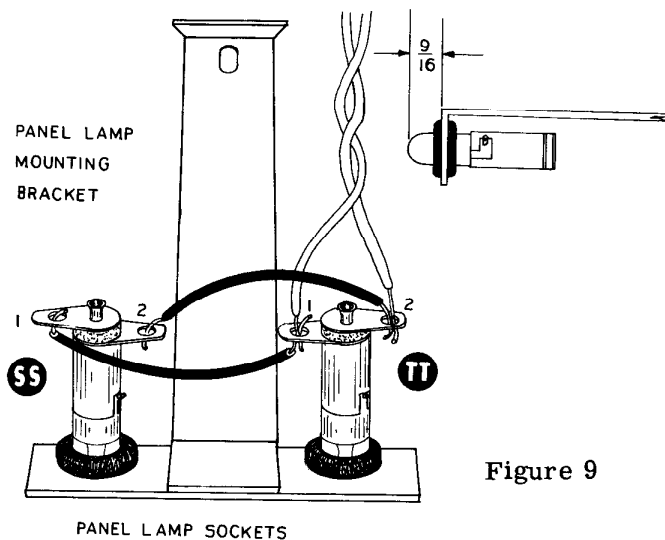

Figure 9

plate so that the lamp bracket fits snugly against the mounting plate. Secure the handle of the panel lamp bracket to the chassis with a 6-32 screw, lockwasher and nut.

- () Make a small coil of the connecting cable, leaving about 9" free at the end. Pass this end of the cable through grommet FF. Connect one wire to DD1 (NS) and the other to BB11 (NS).

TRANSFORMER MOUNTING AND WIRING

- () Examine the color coded leads on the transformer and mount it on the chassis as shown in Pictorial 8 on Page 29. Use 8-32 screws, flat washers, lockwashers and nuts. The transformer leads are cut to the proper length at the factory and should NOT be shortened.
- () Pass the red-yellow (30v) lead through grommet EE and connect it to CC10 (S-3). Dress the lead as shown in Pictorial 8.
- () Pass the red-white (0v) lead through grommet EE and connect it to CC6 (S-2).
- () Connect the red-blue (100v) lead to HH4 (S-2).
- () Connect the red (250v) lead to HH1 (S-2).

In the succeeding steps, pass the leads through grommet JJ.

- () Connect the black (0 volt primary) lead to LL2 (NS).
- () Connect the blue-green (135v) lead to AA2 (S-1).
- () Connect the blue-white (130v) lead to AA3 (S-1).
- () Connect the black-white (125v) lead to AA4 (S-1).
- () Connect the black-green (120v) lead to AA5 (S-1).
- () Connect the black-blue (115v) lead to AA6 (S-1).
- () Connect the black-orange (110v) lead to AA7 (S-1).
- () Connect the black-violet (105v) lead to AA8 (S-1).
- () Connect the black-yellow (100v) lead to AA9 (S-1).
- () Connect the black-red (95v) lead to AA10 (S-1).

In the succeeding steps, pass the leads through grommet KK.

- () Pass the black (0 volt filament) lead through the grommet and connect it to DD1 (S-4). Dress the lead as shown in Pictorial 8.
- () Connect the black-yellow (110v) lead to BB20 (S-2).
- () Connect the black-violet (70v) lead to BB19 (S-1).
- () Connect the blue-yellow (50v) lead to BB18 (S-1).
- () Connect the green-blue (32v) lead to BB17 (S-1).
- () Connect the brown-yellow (25v) lead to BB16 (S-1).
- () Connect the yellow (19.6v) lead to BB15 (S-1).
- () Connect the white-orange (12.6v) lead to BB14 (S-1).
- () Connect the blue-orange (9.45v) lead to BB13 (S-1).
- () Connect the violet (7.5v) lead to BB12 (S-1).
- () Connect the blue (6.3v) lead to BB11 (S-2).
- () Connect the orange (5v) lead to BB10 (S-1).
- () Connect the white (4.7v) lead to BB9 (S-1).

- () Connect the brown (4.2v) lead to BB8 (S-1). Dress the lead under the transformer as shown in Pictorial 8.
- () Connect the gray (3.15v) lead to BB7 (S-1). Dress the lead under the transformer.
- () Connect the green-white (2.5v) lead to BB6 (S-1).
- () Connect the green-orange (2.35v) lead to BB5 (S-1).
- () Connect the green-yellow (2v) lead to BB4 (S-1).
- () Connect the green-red (1.4v) lead to BB3 (S-1).
- () Connect the green (.63v) lead to BB2 (S-1).
- () Insert the line cord through grommet MM and tie a strain relief knot about 1 1/2" from the end. Connect one lead to LL1 (S-2) and the other to LL2 (S-2). Tin the line cord leads before installation.
- () Connect the grid clip to one end of the grid clip test lead as shown in Detail 1. Pass the other end through grommet Q and tie it around the base of terminal strip RR. Connect the lead to RR (S-2).
- () Referring to Pictorial 8, cable the transformer leads coming through grommets JJ and KK. A short length of hookup wire or masking tape may be used for this operation. Any excess length may be pulled above the chassis. Be sure the transformer leads do not interfere with the action of the roll chart mechanism.

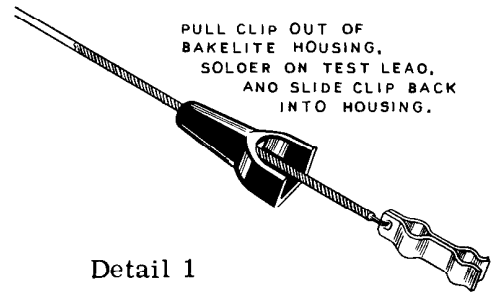

Detail 1

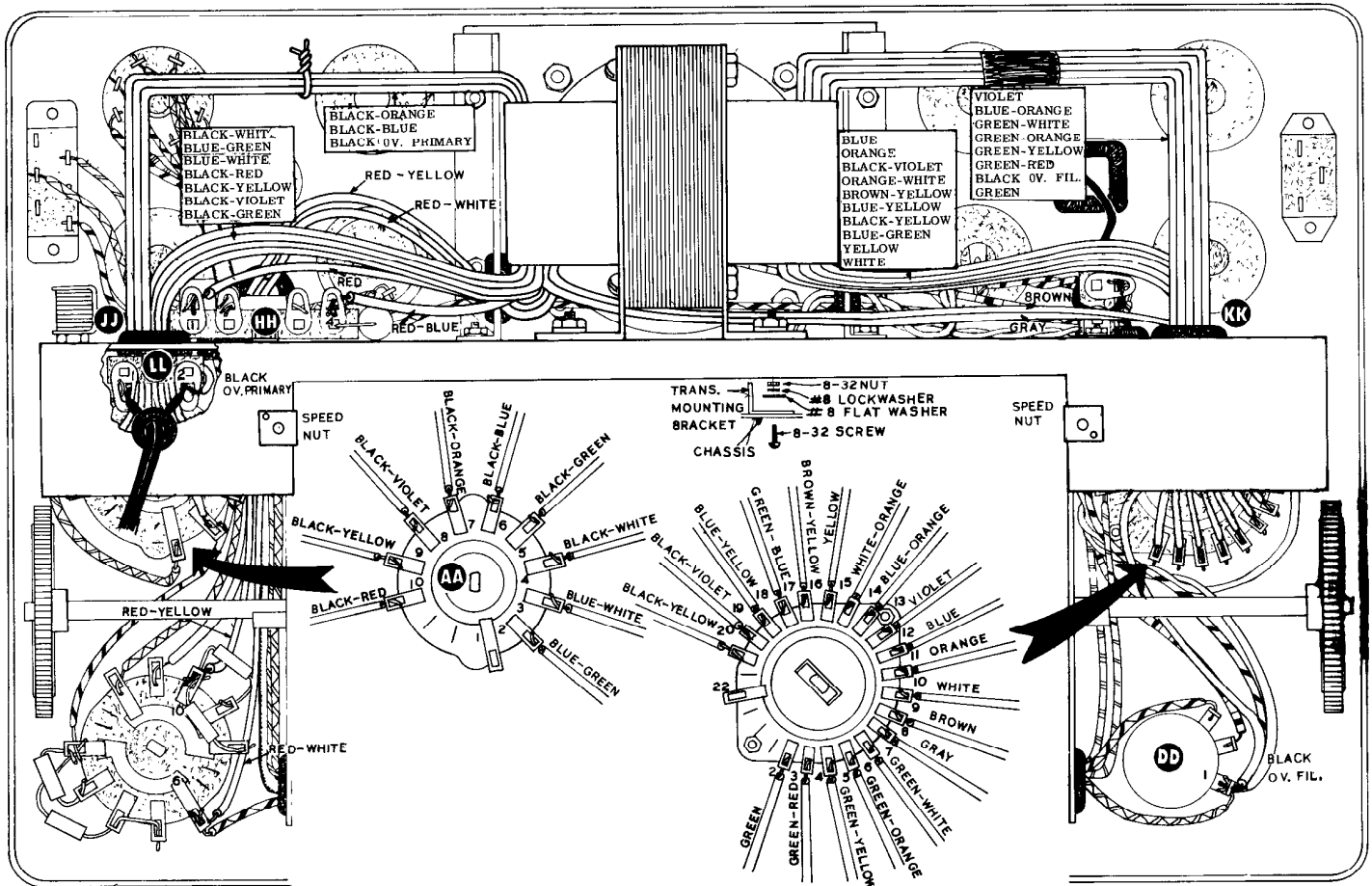

PICTORIAL 8

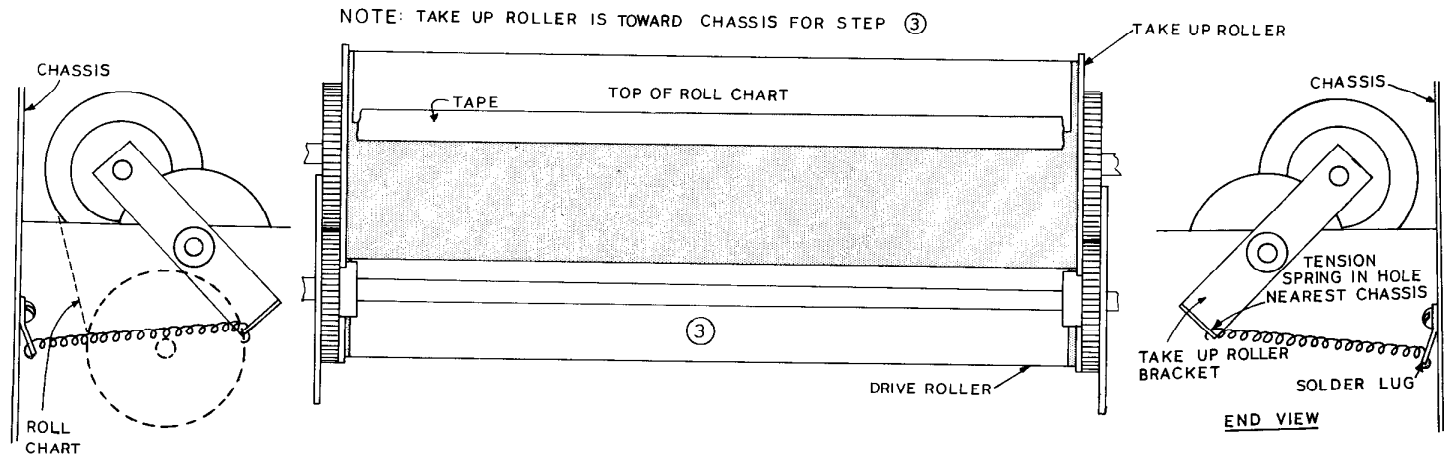
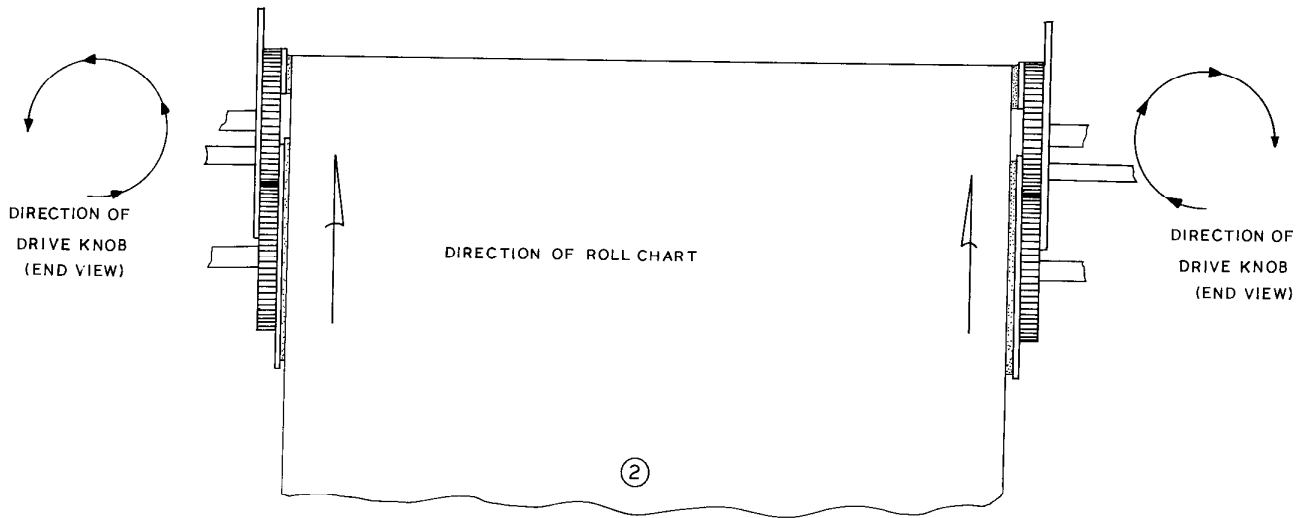
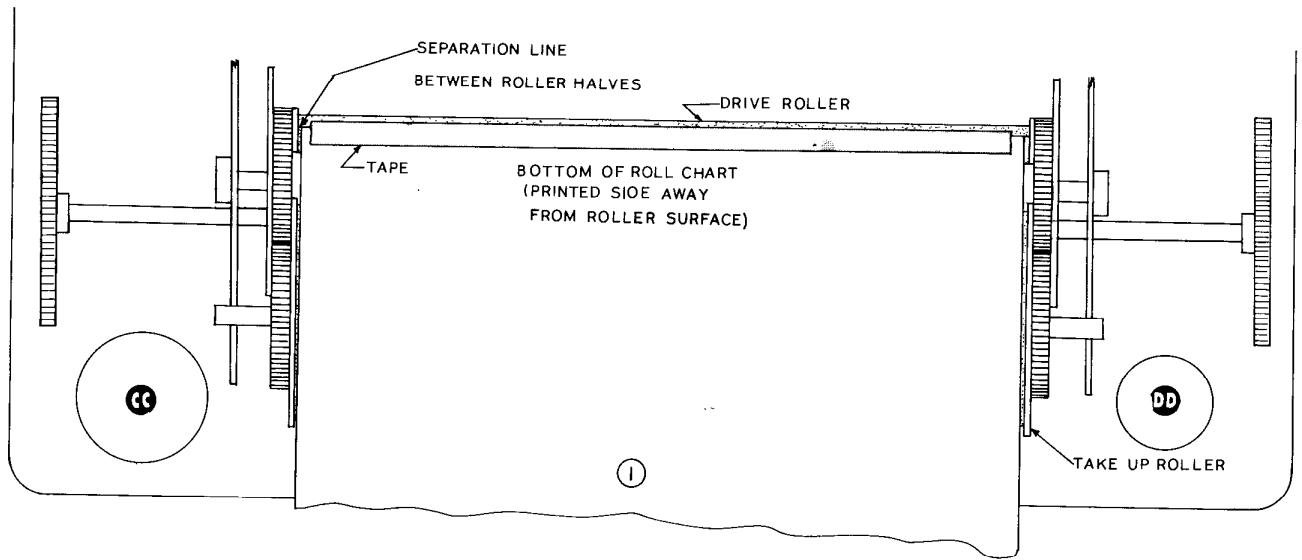
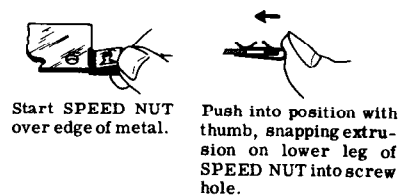

Figure 10

- () Install the roll chart on the drive roller as shown in Figure 10-1. Line up the bottom of the chart with the separation line between the two halves of the roller. Tape the chart to the roller with the masking tape provided.
- () Roll the chart on the drive roller, turning the roller with one hand and guiding the chart with the other. Use the take-up roller as a guide to keep the chart straight as it winds up on the top roller. See Figure 10-2.
- () Push the take-up roller toward the chassis and tape the top of the chart as shown in Figure 10-3. Roll the chart back and forth through its entire length several times to make sure it does not bind at either end. Keep the chart taut by pulling back slightly on the take-up roller shaft.
- () Install the take-up roller tension springs as shown in Figure 10-3.
- () Slide the speed nuts onto the chassis flange. See Pictorial 8 on page 29.
- () Install the control knobs and lever switch knobs. In some cases it may be necessary to loosen the control nut and rotate the switch slightly in order to line up the pointer on the knob with the indexing marks on the panel. In each case the control shaft should be rotated to its maximum counterclockwise position and the knob installed pointing toward the maximum counterclockwise indexing mark (OFF, 1, 0).



The lever switch knobs should be carefully inspected before installation. Correctly position the knob on the lever arm before slowly pushing it on. Two additional knobs have been supplied with the kit to be used as spares. Retain them for possible future use.

- () Check all wiring to be sure it will not interfere with cabinet installation. No wiring should be closer than 1/8" to the edges of the panel.

TESTING

CAUTION: If the neon short lamp lights during testing, turn the Tube Checker off immediately and systematically trouble-shoot the circuit for possible cause of difficulty. The short test indicator should not indicate any glow during the testing procedure if the instrument is correctly wired.

Plug the line cord into a 117 volt AC, 50/60 cycle power supply. Never use 25 cycle or DC supply voltage as the power transformer will suffer severe damage. Turn the instrument on by rotating the SET LINE control. The panel lamps should light immediately and the meter pointer should deflect up-scale. Rotate the SET LINE control back and forth through several positions. The panel lamps should become brighter and the meter pointer should deflect further up-scale as the control is rotated clockwise.

If an AC voltmeter is available, the filament voltages may be checked as follows:

1. Rotate the SET LINE control until the Tube Checker meter pointer falls in the LINE TEST block at mid-scale.
2. Push one test probe into terminal 1 of the octal socket and the other into terminal 5.
3. Pull down lever switch E into the BOTTOM position, leaving all other lever switches in the CENTER position.
4. Rotate the FILAMENT control through all positions. The voltmeter reading should increase as the FILAMENT control is rotated clockwise. Any deviation from this pattern indicates improper transformer wiring. The reading of the voltmeter should substantially agree with the setting of the filament control.

The following chart is provided so that the high voltage secondary of the transformer may be checked for proper connections. Before making the voltage checks, rotate the SET LINE control till the meter pointer falls in the LINE TEST block at mid-scale.

Connect AC voltmeter test leads to:	Meter should read: ($\pm 10\%$)
DD3 and CC10	30 volts AC
DD3 and HH4	100 volts AC
DD3 and HH1	250 volts AC

If preliminary tests indicate the Tube Checker to be functioning properly, the action of the instrument can be further tested by making actual tests on a variety of tubes. Remember that for the purpose of testing the instrument, a tube known to be defective in some way may be just as useful, if not more so, than a tube which is perfect in every respect.

CABINET INSTALLATION

- () Install the rubber feet in the bottom and back of the cabinet.
- () Install the handle using #10 sheet metal screws.
- () Place the Tube Checker face down on your work bench. Slide the line cord through the hole in the back of the cabinet and push the cabinet down inside the flanges at the edge of the panel. Secure with two 6-32 screws.



USING THE HEATHKIT TC-3 TUBE CHECKER

The instrument you have just completed will provide a variety of tests to indicate the relative value of the particular tube being checked. The following steps may be used as a guide in setting up tube testing procedures. Remember that the ultimate value of any measuring device is dependent upon the skill of the operator and, more important, his ability to properly evaluate the information provided by the instrument.

- (1) With the power cord connected, move the roll chart to the listing of the tube to be tested, and turn the SET LINE control until the meter pointer falls within the LINE TEST block.
- (2) Set the TYPE switch to the number shown on the chart.
- (3) Set the FILAMENT selector to the voltage shown on the chart.
- (4) Set the PLATE control according to the chart information.
- (5) Set the LEVER switches to the T-TOP and B-BOTTOM positions as shown in the top and bottom columns on the chart.
- (6) Insert the tube and re-set the SET LINE control if necessary. Pin positions and keyways determine tube positioning on all sockets except subminiature. For subminiature tubes, position color dot adjacent to color dot on panel.
- (7) Check the tube for shorts by moving levers shown in light type through the two positions, returning to the position shown on the chart. The TEST switch remains in the SHORT position for this test. The SHORT-LEAKAGE switch should be in the SHORT position. A shorted tube is indicated by a steady glow of the neon bulb. Disregard neon bulb flashing as the lever switches are moved. It is possible that some serious short circuits will momentarily overload the power transformer. This condition will be indicated by complete dim out of the panel lamps. Do not allow the Tube Checker to operate under this extreme condition for any length of time. Make the test as quickly as possible in order to obtain the desired information. CAUTION: The following note concerning internal connections appears at the bottom of the roll chart: "*Special short test for tubes with internal connections. A good tube will not show short when the levers shown in parenthesis () are moved simultaneously." When testing a tube type marked with the asterisk, it is important to move the levers simultaneously to prevent damage to the internal connections.

- (8) Check the tube for leakage between elements by moving the SHORT-LEAKAGE switch to the LEAKAGE position and repeating the short test as outlined above.
- (9) After allowing sufficient time for the tube to reach operating temperature, check for quality by moving the test slide switch to TEST position. If the meter pointer falls in the GREEN scale, the quality of the tube is GOOD.
- (10) Check for open elements as follows: holding the slide switch in the TEST position, move each lever in the TOP position (only those shown in light type) to the BOTTOM position and return. Satisfactory tube elements (those properly connected to their pins) are indicated by a decrease in meter reading. The grid element usually shows a large decrease, while a screen or plate may show only a slight decrease.

NOTE: If the meter indication in the quality test is off scale, reduce the meter reading to an on-scale reading by turning the PLATE control counterclockwise, then proceed with the open element test.

- (11) To check filaments, filament taps and internal connections for continuity, set the FILAMENT selector to .63 volts. Move each lever shown in dark type through each of its other two positions. Always move only one lever at a time. Satisfactory filaments, taps and internal connections will be shown by a bright glow of the SHORT test indicator.

In any of the above tests, should the tube prove to be faulty in some respect, the defective element can be traced by comparing the lever switch in question with a base diagram of the tube. Lever switch A corresponds to tube pin 1, lever switch B to tube pin 2, etc.

Multiple tube types (tubes which contain more than one set of elements) are indicated on the chart by a bracket set of listings, one for each test to be made on the tube. The tester is set up according to the test in each line and checked through all of the tests as outlined in the preceding steps.

Check pilot lights by setting the FILAMENT selector to the proper voltage and inserting the pilot light in the socket found in the center of the large seven pin socket. This is a universal type pilot light test socket and does not require that the lamp be permanently inserted. It is only necessary to hold the pilot lamp so that the side wall of the base and the center pin of the lamp make contact with the corresponding points in the lamp socket.

NEW TUBES

The Heath Company periodically revises the Tube Checker roll chart in order to keep abreast of new tube releases. However, because of the great quantity of new tubes being released by manufacturers, a customer will occasionally desire to check a new tube before the test data appears on the roll chart. If the tube you wish to check does not fit any of the sockets provided, it will be necessary for you to obtain the proper socket from a local source and mount it in the blank socket location. Wire it in as follows:

- (1) Connect pin one of the new socket to pin one (brown wire) of the octal socket.
- (2) Connect pin 2 of the new socket to pin 2 (red wire) of the octal socket, etc. If the new socket has nine pins, connect pin No. 9 to S9 on the 9-pin miniature tube socket. If the new socket has 10 pins, connect pin No. 10 to terminal K4 on the lever switch gang.

In the event the new socket will not fit into the blank socket location, make it into an adaptor using an octal plug. Connections to pins 9 and 10 may then be made by test leads to S9 and the grid clip, respectively.

The instructions below indicate how to set up the instrument for obtaining temporary settings so that these new tubes may be checked (provided manufacturer's data is available).

- (1) Note manufacturer's data carefully concerning the base diagram of the pin connections and filament voltage.
- (2) Set the Tube Checker TYPE switch as follows:
 - Type 1 - for low cathode current tubes (below 4 ma), usually diode types.
 - Type 2 - for tube types with cathode current between 3 ma and 15 ma. These are usually filament type tubes with the exception of diodes.
 - Type 3 - for tube types with cathode current greater than 8 ma. These are usually indirect-heated cathode types with the exception of diodes.
 - Type 4 - for gas control tubes, gaseous rectifiers, and eye or target tubes.
- (3) Set FILAMENT voltage to value specified by manufacturer.
- (4) Set all levers to the CENTER position.
- (5) Determine the first filament connection from the tube base diagram and leave its connection lever in the CENTER position. Its connection lever corresponds to the letter on the lever— A corresponds to pin 1, B to pin 2, C to pin 3, etc.
- (6) Determine the second filament connection from the tube base diagram and set its connection lever to the BOTTOM position.
- (7) Determine from base diagram if the tube has a filament tap. The position of the lever corresponding to the filament tap will depend upon the placement of the tap in respect to the other filament connections. Some filament taps are placed in the center of the filament, as in the 12AU7. For this type filament, the two outer terminals (pins 4 and 5) are connected to one side of the filament supply (levers in CENTER position) and the tap is connected to the other side (lever in BOTTOM position). The FILAMENT control is then set at 1/2 the voltage rating of the entire filament, or (in this case) $12.6/2 = 6.3$ volts. When the filament tap is not symmetrically located, as in the 35Z5, the tap must be connected to that end of the filament which is electrically nearer the tap position. For the 35Z5, pins 2 and 3 should be connected to one side of the filament supply and pin 7 to the other. The FILAMENT control is then set to the voltage closest to that recommended by the tube manufacturer, in this case 32 volts.
- (8) If the tube has more than one section (duo diodes, duo triodes, etc.) make a separate test for each section. For the section being tested follow instructions below. For the section not being tested, move all corresponding connection levers to the bottom position. If the tube has only one section, follow the instructions below.
- (9) Move the connection lever corresponding to the cathode to the BOTTOM position.
- (10) Move all other elements of the section being tested (screens, suppressors, grids, etc.) to the TOP position.
- (11) Plug the tube into the correct socket
- (12) Plug the line cord into the power supply and turn the instrument on.
- (13) Adjust the SET LINE control till the meter pointer falls in the LINE TEST block.
- (14) Hold the ADJUST LINE SHORT-TEST switch in the TEST position and adjust the PLATE control to bring the pointer to the middle of the GOOD scale. (If possible, make this adjustment for at least three new tubes of the same type and select the average setting.)
- (15) List all these settings in the space provided at the back of the manual.

- (16) If the tube is of the multi-section type, check the remaining sections in the manner outlined above and list the settings in the manual.

IN CASE OF DIFFICULTY

- (1) Re-check all the wiring. Follow each lead on the schematic diagram with a colored pencil and trace it out on the instrument. Most cases of difficulty result from wrong or reversed connections. (Often it is helpful to have a friend check the wiring - he may be able to discover an error consistently being overlooked.)
- (2) Check the voltages in the manner outlined under TESTING. This may help to show up a mis-interpretation of the transformer lead identification code.
- (3) Make continuity checks between the lever switch common lugs and the various socket pins to make sure that all contacts are properly connected to the lever switches.
- (4) If you are unable to locate the difficulty, write to the Heath Company Technical Consultation Service department, supplying all possible pertinent information. Include voltage data, as well as any characteristic of operation that may afford a clue to the difficulty. Trained technical correspondents will analyze the problem and suggest the corrective measures that may be required.

SERVICE INFORMATION

SERVICE

If, after applying the information contained in this manual and your best efforts, you are still unable to obtain proper performance, it is suggested that you take advantage of the technical facilities which the Heath Company makes available to its customers.

The Technical Consultation Department is maintained for your benefit. This service is available to you at no charge. Its primary purpose is to provide assistance for those who encounter difficulty in the construction, operation or maintenance of HEATHKIT® equipment. It is not intended, and is not equipped to function as a general source of technical information involving kit modifications nor anything other than the

normal and specified performance of HEATHKIT® equipment.

Although the Technical Consultants are familiar with all details of this kit, the effectiveness of their advice will depend entirely upon the amount and the accuracy of the information furnished by you. In a sense, **YOU MUST QUALIFY** for **GOOD** technical advice by helping the consultants to help you. Please use this outline:

1. Before writing, fully investigate each of the hints and suggestions listed in this manual under "IN CASE OF DIFFICULTY." Possibly it will not be necessary to write.
2. When writing, clearly describe the nature of the trouble and mention all associated

equipment. Specifically report operating procedures, switch positions, connections to other units and anything else that might help to isolate the cause of trouble.

3. Report fully on the results obtained when testing the unit initially and when following the suggestions under "IN CASE OF DIFFICULTY." Be as specific as possible and include voltage readings if test equipment is available.
4. Identify the kit model number and date of purchase, if available.
5. Print or type your name and address, preferably in two places on the letter.

With the preceding information, the consultant will know exactly what kit you have, what you would like it to do for you and the difficulty you wish to correct. The date of purchase tells him whether or not engineering changes have been made since it was shipped to you. He will know what you have done in an effort to locate the cause of trouble and, thereby, avoid repetitious suggestions. (The automatic letter opener sometimes cuts through the letter, hence the suggestion to print the name and address twice.) In short, he will devote full time to the problem at hand, and through his familiarity with the kit, plus your accurate report, he will be able to give you a complete and helpful answer. If replacement parts are required, they will be shipped to you, subject to the terms of the Warranty.

The Factory Service facilities are also available to you, in case you are not familiar enough with electronics to provide our consultants with sufficient information on which to base a diagnosis of your difficulty, or in the event that you prefer to have the difficulty corrected in this manner. You may return the completed instrument to the Heath Company for inspection and necessary repairs and adjustments. You will be charged a minimal service fee, plus the price of any additional parts or material required. However, if the completed kit is returned within the Warranty period, parts charges will be governed by the terms of the Warranty. State the date of purchase, if possible.

Local Service by Authorized HEATHKIT Serv-

ice Centers is also available in some areas and often will be your fastest, most efficient method of obtaining service for your HEATHKIT equipment. Although you may find charges for local service somewhat higher than for factory service, the amount of increase is usually offset by the transportation charge you would pay if you elected to return your kit to the Heath Company.

HEATHKIT® Service Centers will honor the regular 90 day HEATHKIT® Parts Warranty on all kits, whether purchased through a dealer or directly from Heath Company; however, it will be necessary that you verify the purchase date of your kit.

Under the conditions specified in the Warranty, replacement parts are supplied without charge; however, if the Service Center assists you in locating a defective part (or parts) in your kit, or installs a replacement part for you, you may be charged for this service.

HEATHKIT® equipment purchased locally and returned to Heath Company for service must be accompanied by your copy of the dated sales receipt from your authorized HEATHKIT® dealer in order to be eligible for parts replacement under the terms of the Warranty.

THIS SERVICE POLICY APPLIES ONLY TO COMPLETED EQUIPMENT CONSTRUCTED IN ACCORDANCE WITH THE INSTRUCTIONS AS STATED IN THE MANUAL. Equipment that has been modified in design will not be accepted for repair. If there is evidence of acid core solder or paste fluxes, the equipment will be returned NOT repaired.

For information regarding modification of HEATHKIT® equipment for special applications, it is suggested that you refer to any one or more of the many publications that are available on all phases of electronics. They can be obtained at or through your local library, as well as at most electronic equipment stores. Although the Heath Company sincerely welcomes all comments and suggestions, it would be impossible to design, test, evaluate and assume responsibility for proposed circuit changes for special purposes. Therefore, such modifications must be made at the discretion of the kit builder, using information available from sources other than the Heath Company.

REPLACEMENTS

Material supplied with HEATHKIT® products has been carefully selected to meet design requirements and ordinarily will fulfill its function without difficulty. Occasionally improper instrument operation can be traced to a faulty component. Should inspection reveal the necessity for replacement, write to the Heath Company and supply all of the following information.

- A. Thoroughly identify the part in question by using the part number and description found in the manual Parts List.
- B. Identify the type and model number of kit in which it is used.
- C. Mention date of purchase.
- D. Describe the nature of defect or reason for requesting replacement.

The Heath Company will promptly supply the necessary replacement. PLEASE DO NOT RETURN THE ORIGINAL COMPONENT UNTIL SPECIFICALLY REQUESTED TO DO SO. Do not dismantle the component in question as this will void the guarantee. This replacement policy does not cover the free replacement of parts that may have been broken or damaged through carelessness on the part of the kit builder.

SHIPPING INSTRUCTIONS

In the event that your instrument must be returned for service, these instructions should be carefully followed.

ATTACH A TAG TO THE EQUIPMENT BEARING YOUR NAME, COMPLETE ADDRESS, DATE OF PURCHASE, AND A BRIEF DESCRIPTION OF THE DIFFICULTY ENCOUNTERED. Wrap the equipment in heavy paper, exercising care to prevent damage. Place the wrapped equipment in a stout carton of such size that at least three inches of shredded paper, excelsior, or other resilient packing material can be placed between all sides of the wrapped equipment and the carton. Close and seal the carton with gummed paper tape, or alternately, tie securely with stout cord. Clearly print the address on the carton as follows:

To: HEATH COMPANY
Benton Harbor, Michigan

Include your name and return address on the outside of the carton. Preferably affix one or more "Fragile" or "Handle With Care" labels to the carton, or otherwise so mark with a crayon of bright color. Ship by parcel post or prepaid express; note that a carrier cannot be held responsible for damage in transit if, in HIS OPINION, the article is inadequately packed for shipment.

SPECIFICATION CHANGES

All prices are subject to change without notice. The Heath Company reserves the right to discontinue instruments and to change specifications at any time without incurring any obligation to incorporate new features in instruments previously sold.

SUGGESTED READING LIST

This manual is written to enable the owner of this instrument to successfully assemble and operate it. It is not intended as an exhaustive treatise on the subject of tube checkers. Further information may be obtained from the many fine textbooks, magazine articles and technical manuals which have been written about tube testing and related subjects. A few of these sources are listed below.

Brans, P. H. "World's Radio Tubes"
Eastman "Fundamentals of Vacuum Tubes"
Terman and Petit "Electronic Measurements"
Spangenburg, K. R. "Vacuum Tubes"
Geppert "Basic Electron Tubes"
RCA Receiving Tube Manual
CBS Engineers Handbook

PARTS LIST

PART No.	PARTS Per Kit	DESCRIPTION	PART No.	PARTS Per Kit	DESCRIPTION
Resistors			Hardware (con't)		
1-5	1	360Ω 5% (orange-blue-brown)	250-83	2	#10 sheet metal screw
1-26	1	100 KΩ (brown-black-yellow)	250-89	30	6-32 x 3/8" BH screw
1-30	1	270 KΩ (red-violet-yellow)	252-3	26	6-32 x 1/4" nut
1-37	1	2.2 megohm (red-red-green)	252-4	4	8-32 x 5/16" nut
1-79	1	820Ω 5% (gray-red-brown)	252-7	4	Control nut
1-9	1	1000Ω 10% (brown-black-red)	252-22	2	Speed nut
1-81	1	1500Ω 5% (brown-green-red)	253-9	4	#8 flat washer
1-82	1	3600Ω 5% (orange-blue-red)	253-10	4	Control flat washer
2-21A	1	75 KΩ precision	253-36	2	1/4" Spring washers
3-1E	1	2500Ω 7 watt wirewound	254-1	26	#6 lockwasher
Controls-Capacitors-Switches			254-2	4	#8 lockwasher
11-12	1	200Ω wirewound control	254-4	4	Control lockwasher
23-11	1	.1 mfd tubular capacitor	258-4	2	Spring
60-3	1	DPDT spring return slide switch	259-1	2	#6 solder lug
60-4	1	SPDT slide switch	Grommets-Wire		
62-7	1	3 position, 10 gang lever switch	73-1	1	3/8" rubber grommet
63-17	1	2-pole, 4 position rotary switch	73-2	9	3/4" rubber grommet
63-167	1	SP, 20 position rotary switch	73-3	3	1/2" rubber grommet
63-168	1	SP, 10 position rotary switch	89-1	1	Line cord
Lamps-Terminal Strips-Sockets-Knobs			261-4	8	Rubber feet
412-1	2	#47 panel lamp	340-2	1	length Bare wire
412-3	1	NE51 neon bulb	341-1	1	Grid clip test lead
431-2	1	2-lug terminal strip	344-1	1	length Hookup wire
431-5	2	4-lug terminal strip	347-1	1	length 8-wire cable
431-15	1	1-lug terminal strip	Miscellaneous		
434-1	1	Blank socket	54-72	1	Power transformer
434-4	1	Octal socket	57-6	1	Half wave rectifier
434-6	1	Loctal socket	90-89	1	Cabinet
434-9	1	4 prong socket	211-4	1	Handle
434-11	1	5 prong socket	260-3	1	Grid clip
434-12	1	6 prong socket	407-53	1	Tube checker meter
434-13	1	7 prong combination socket	445-5	1	Roll chart
434-14	1	7 prong miniature socket	451-17	2	Gear
434-17	1	9 prong miniature socket	453-48	1	Roll chart idler shaft
434-21	2	Pilot lamp socket	455-15	2	1/4" retaining collar
434-44	1	Pilot lamp socket	595-208	1	Manual
434-M81	1	7 prong subminiature socket	100-M154	1	Panel insert (escutcheon)
435-1	8	Octal socket ring	100-M157	1	Panel lamp bracket
435-2	2	Miniature socket ring	100-M209	1	Driver roller
435-3	1	Large socket ring	100-M210	1	Takeup roller
435-8	2	Subminiature socket ring	200-M179	1	Chassis
462-7	12	Lever switch knob	203-157F221		
462-52	4	Pointer knob		1	Panel
462-72	2	Thumbwheel drive knob	204-M185	2	Panel support bracket
Hardware			204-M188	1	Roll chart bracket (R. H.)
250-15	2	8-32 x 1/8" setscrew	204-M189	1	Roll chart bracket (L. H.)
250-18	4	8-32 x 3/8" RHMS	204-M190	2	Take-up roller bracket
250-43	2	8-32 x 1/4" setscrew	205-M100	1	Meter mounting plate
250-52	4	4-40 x 1/4" BHMS	448-3	1	Roll masking tape
			597-2	1	Supplement Test Data Sheet

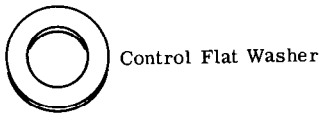

Control Flat Washer

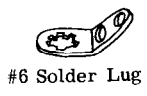

#6 Solder Lug



Speed Nut



Control Nut

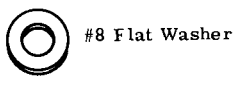

#8 Flat Washer

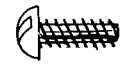

#10 Sheet Metal Screw



Socket Retaining Ring (7 Pin Subminiature)

Control Lockwasher

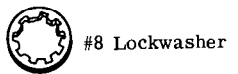
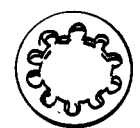

#8 Lockwasher

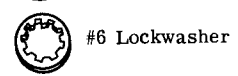

#6 Lockwasher



4-40 BHMS

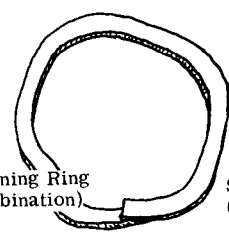

Socket Retaining Ring (7 Pin Combination)

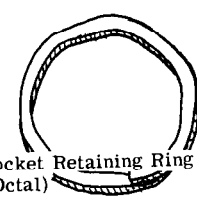

Socket Retaining Ring (Octal)

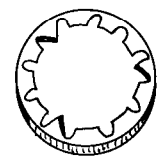

Socket Retaining Ring (7 Pin Miniature)

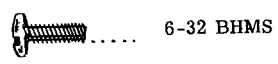

6-32 BHMS



6-32 Nut

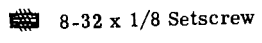

8-32 x 1/8 Setscrew

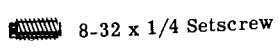

8-32 x 1/4 Setscrew

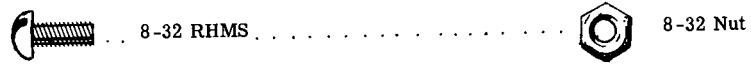

8-32 RHMS



8-32 Nut

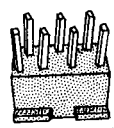

7 Pin Subminiature Socket

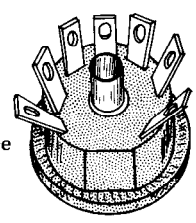

7 Pin Miniature Socket

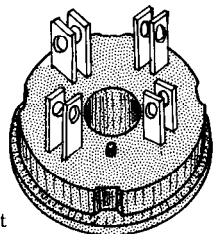

4 Pin Socket

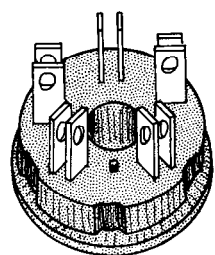

5 Pin Socket

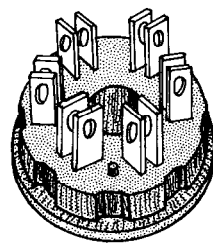

6 Pin Socket

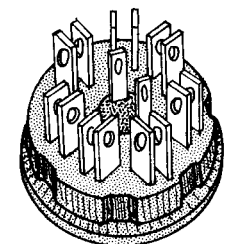

7 Pin Combination Socket

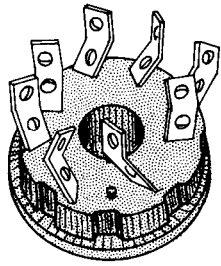

Octal Socket

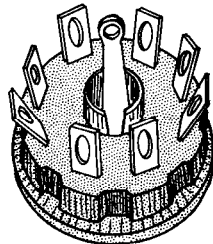

Loctal Socket

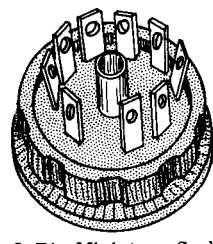

9 Pin Miniature Socket



Rubber foot



1/4" Retaining Collar

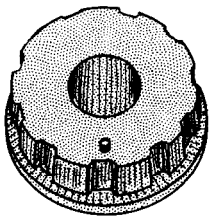

Blank Socket

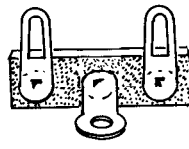

2 lug Terminal Strip

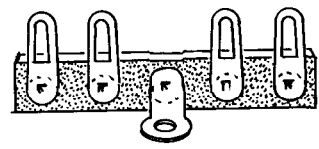

4 lug Terminal Strip

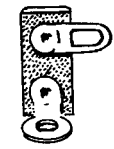

1 lug Terminal Strip

1/2 watt Resistor

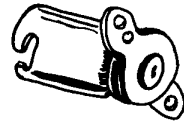

Pilot Light Socket (Panel Lamps)

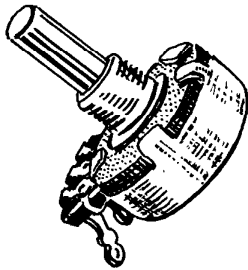

Control

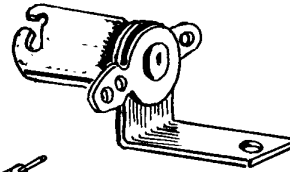

Pilot Light Socket (Short Indicator)

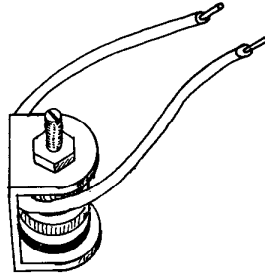

Meter Rectifier

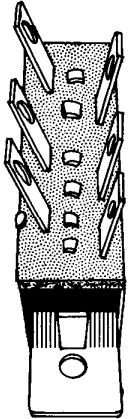

DPDT (Double Pole Double Throw) Spring Return Slide Switch



SPDT (Single Pole Double Throw) Slide Switch

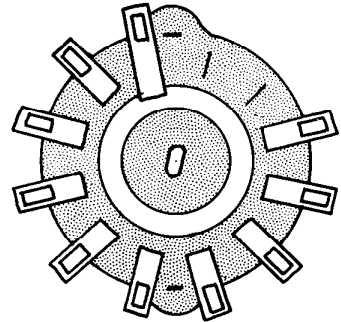

10 Position Line Switch

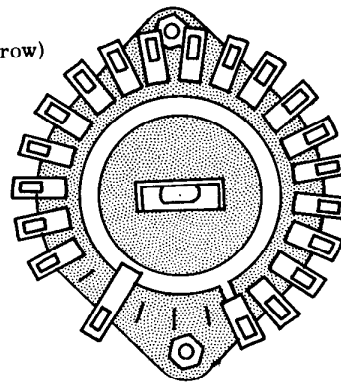

20 Position Filament Switch

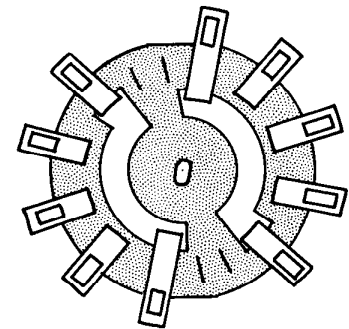

4 Position Type Switch



Grommet for 3/8" dia. hole



Grommet for 1/2" dia. hole



Grommet for 3/4" dia. hole

WARRANTY

Heath Company warrants that for a period of three months from the date of shipment, all Heathkit parts shall be free of defects in materials and workmanship under normal use and service and that in fulfillment of any breach of such warranty, Heath Company shall replace such defective parts upon the return of the same to its factory. The foregoing warranty shall apply only to the original buyer, and is and shall be in lieu of all other warranties, whether express or implied and of all other obligations or liabilities on the part of Heath Company and in no event shall Heath Company be liable for any anticipated profits, consequential damages, loss of time or other losses incurred by the buyer in connection with the purchase, assembly or operation of Heathkits or components thereof. No replacement shall be made of parts damaged by the buyer in the course of handling or assembling Heathkit equipment.

NOTE: The foregoing warranty is completely void and we will not replace, repair or service instruments or parts thereof in which acid core solder or paste fluxes have been used.

HEATH COMPANY

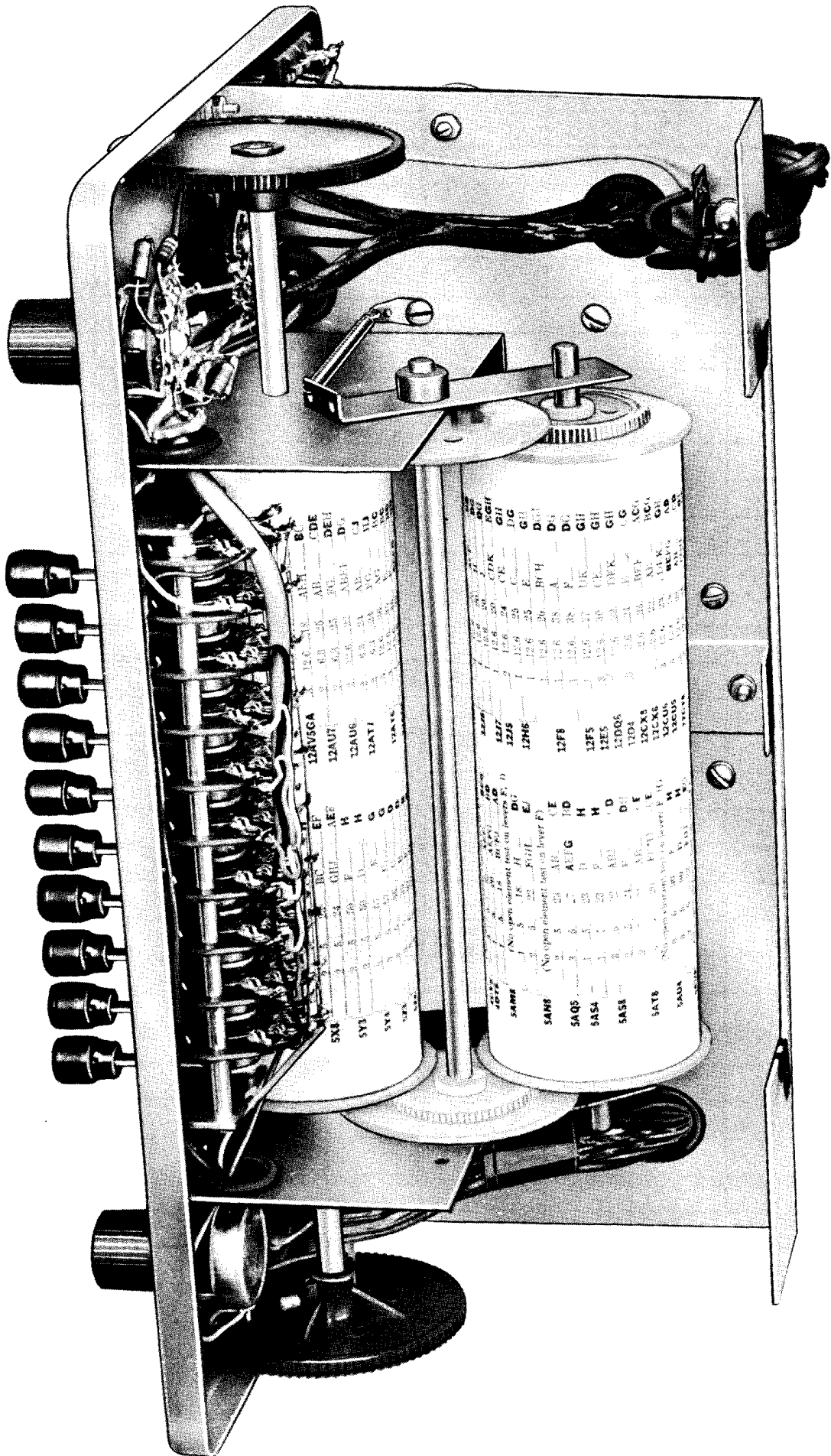

HEATH COMPANY

a subsidiary of

DAYSTROM, INCORPORATED

THE WORLD'S FINEST ELECTRONIC EQUIPMENT IN KIT FORM

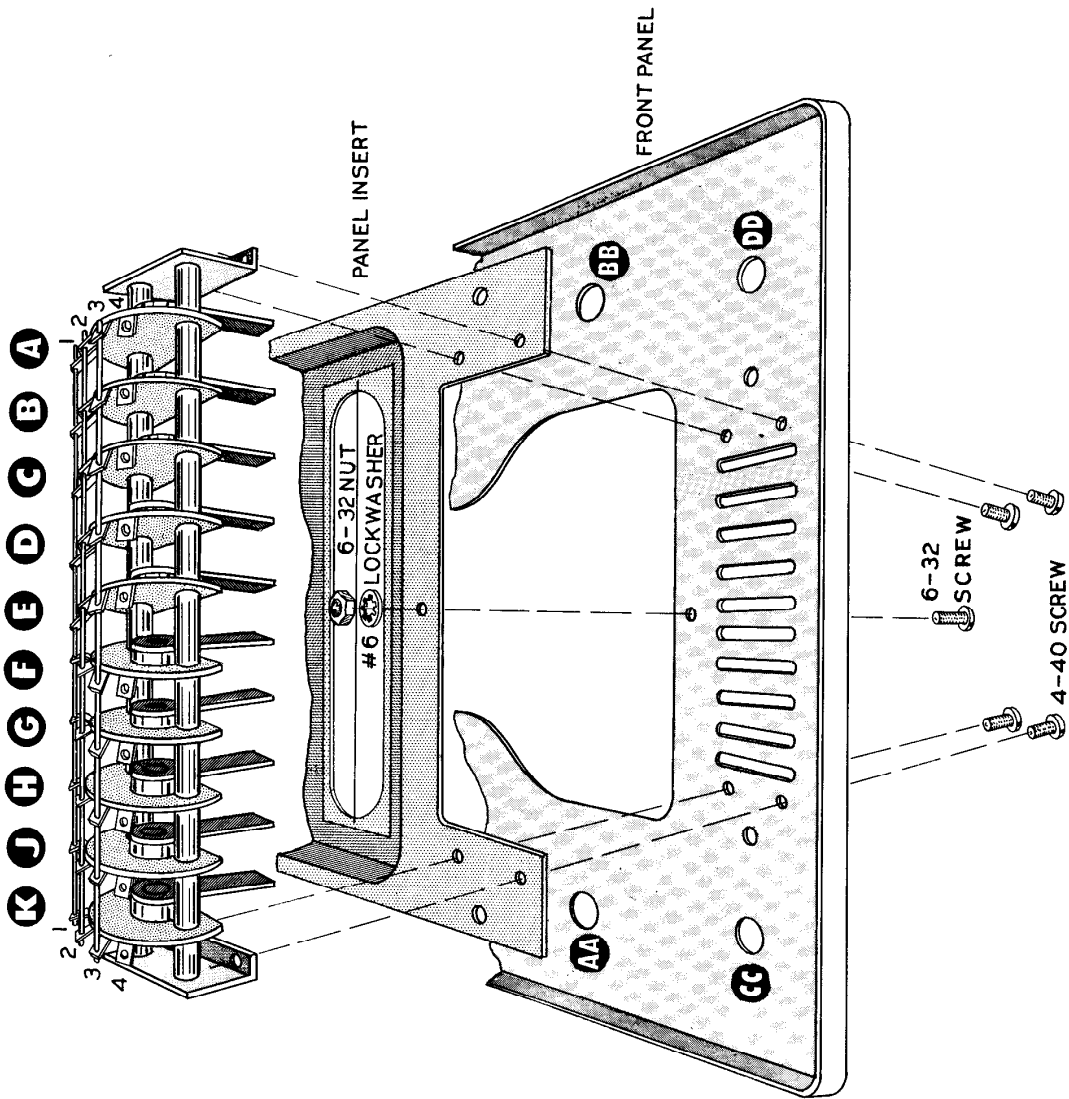
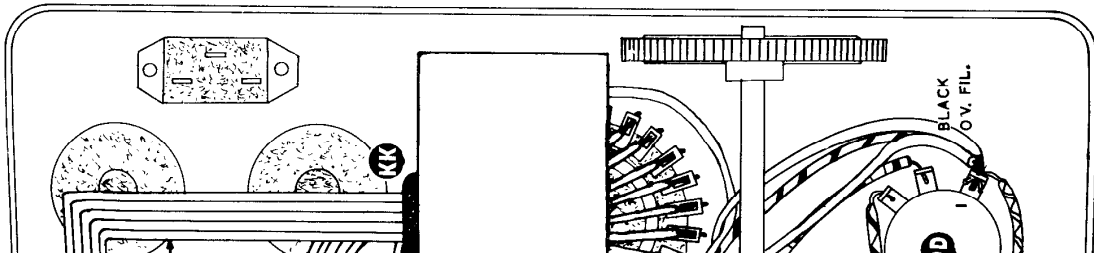
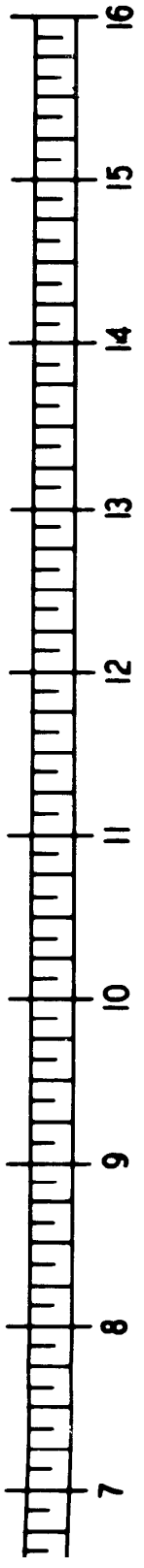
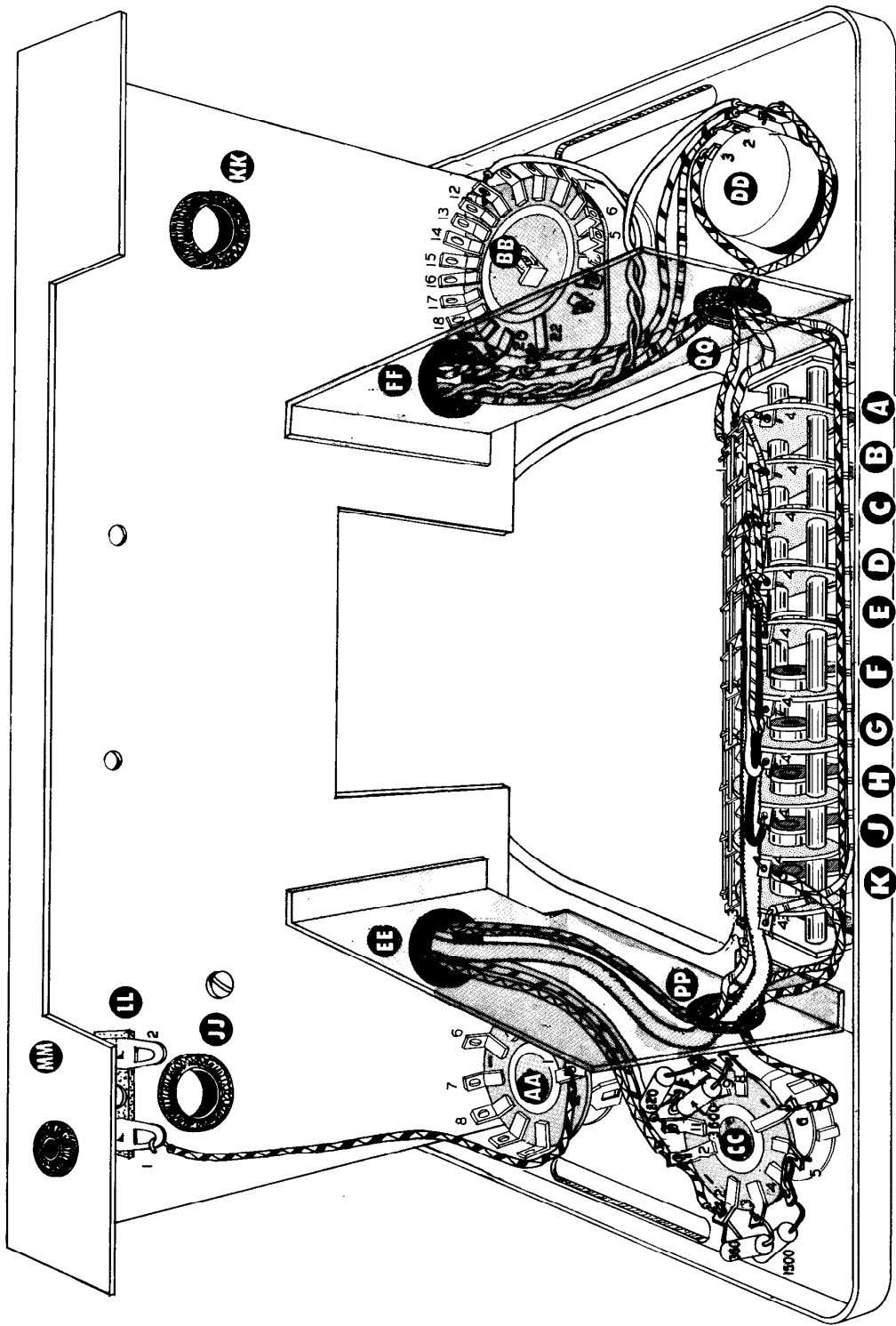
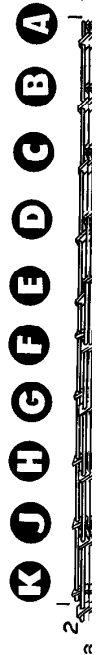

Figure 2





PICTORIAL 6



DI
22

3

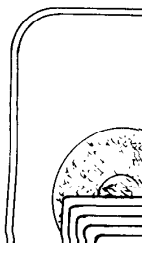

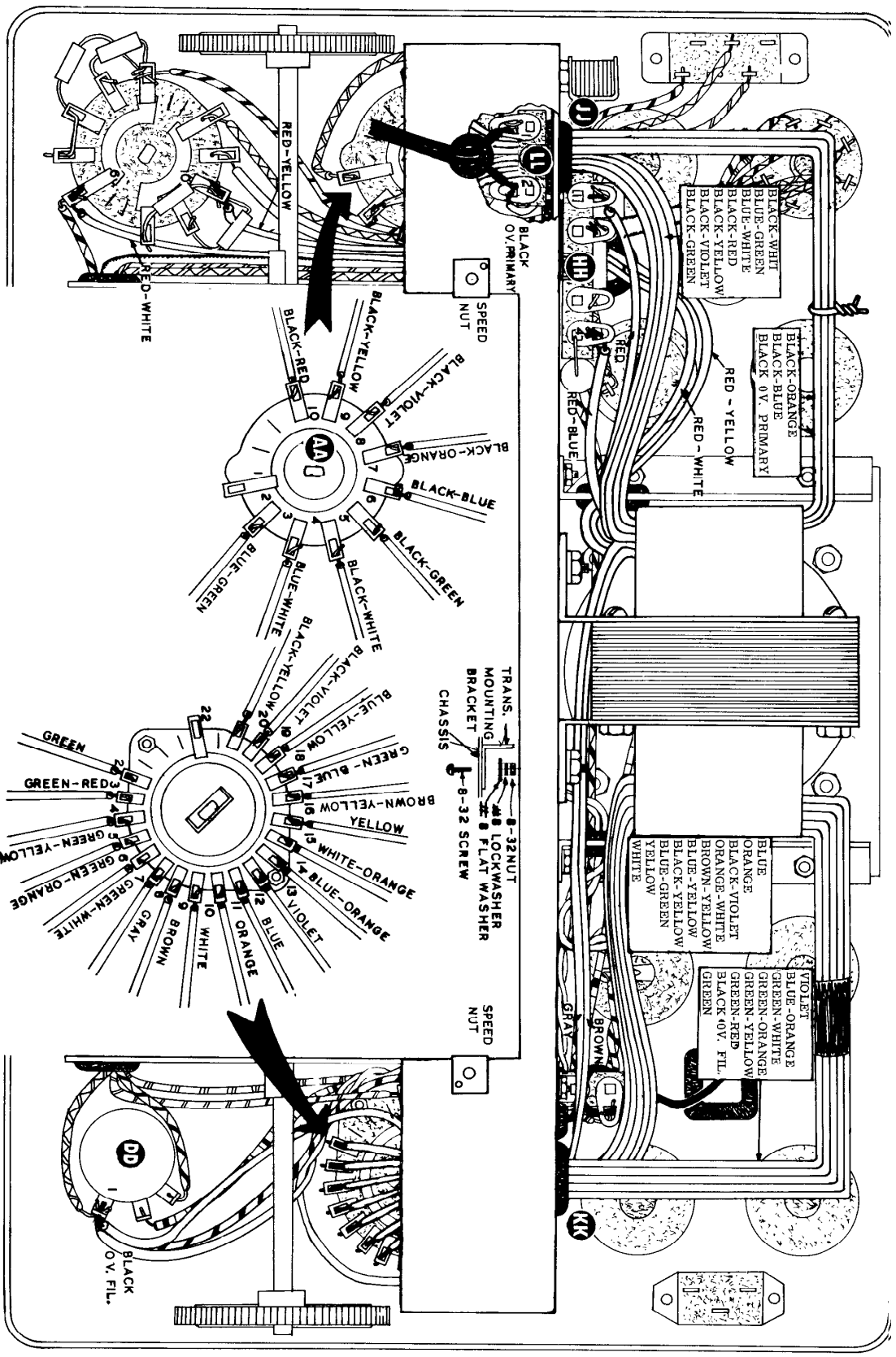

PICTORIAL 8

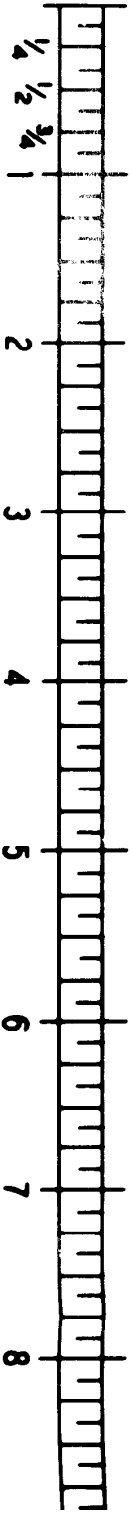

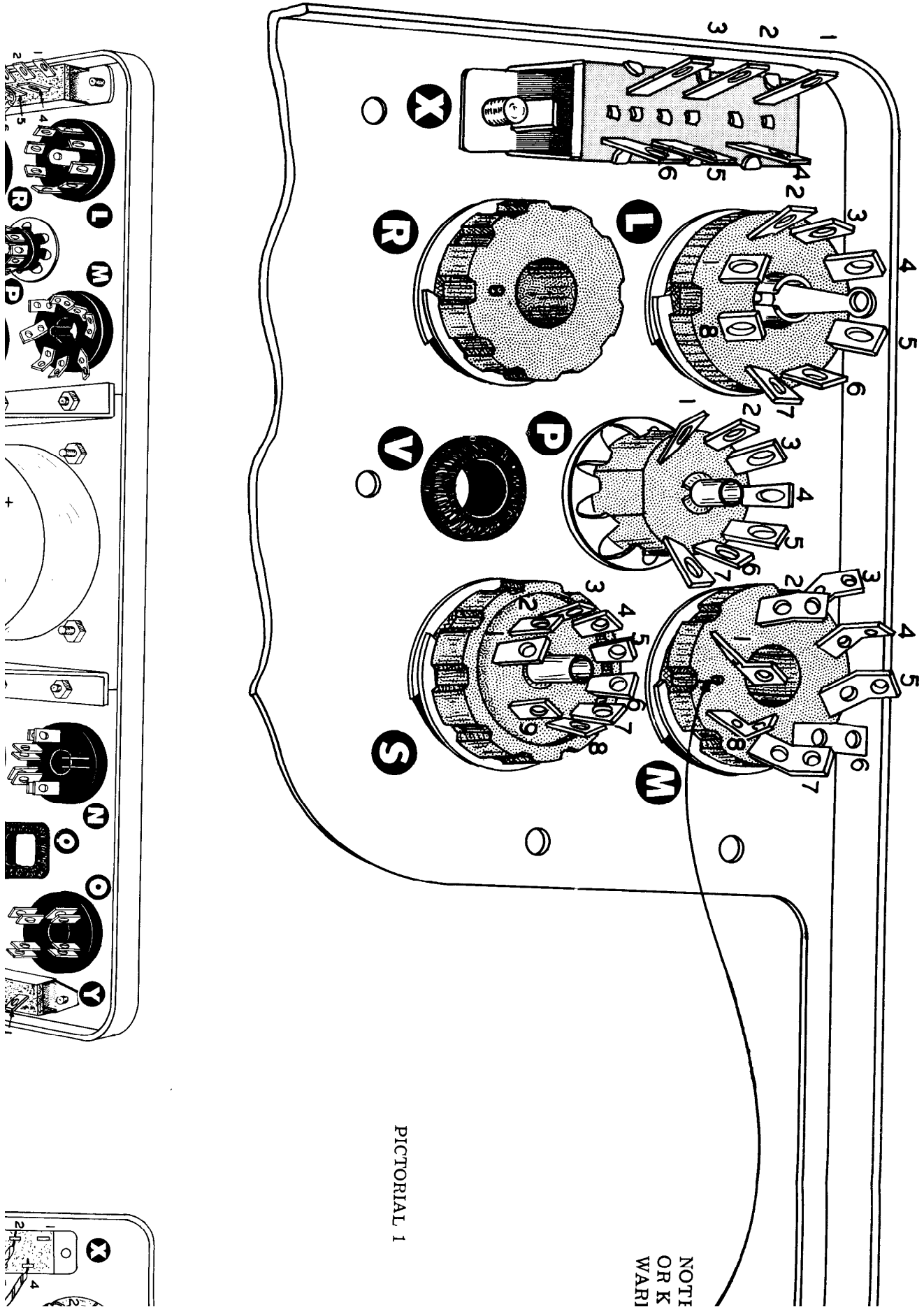

NOTE
OR K
WARI

PICTORIAL 1

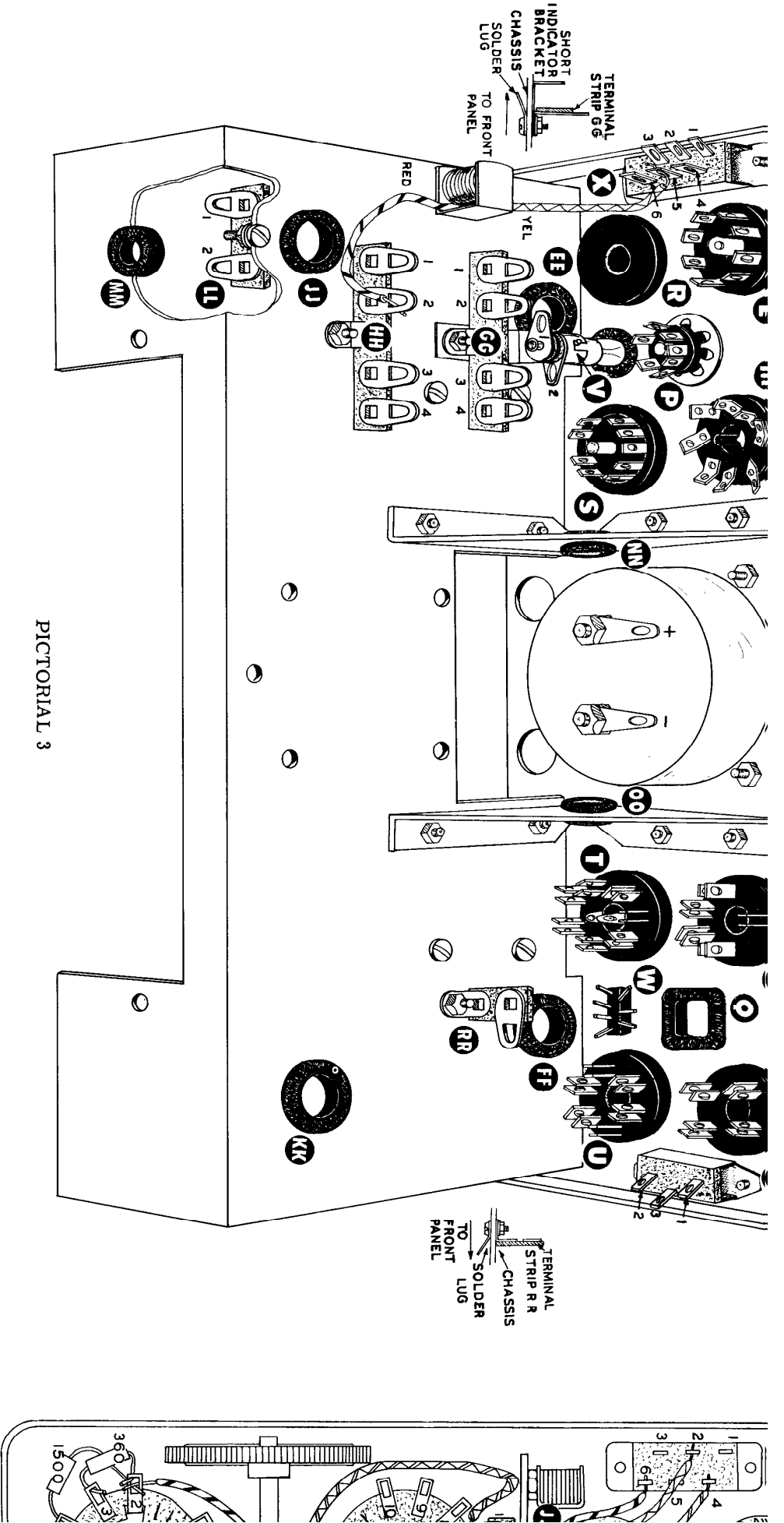

PICTORIAL 3

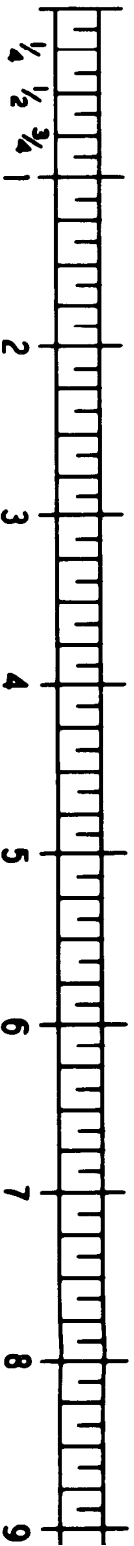

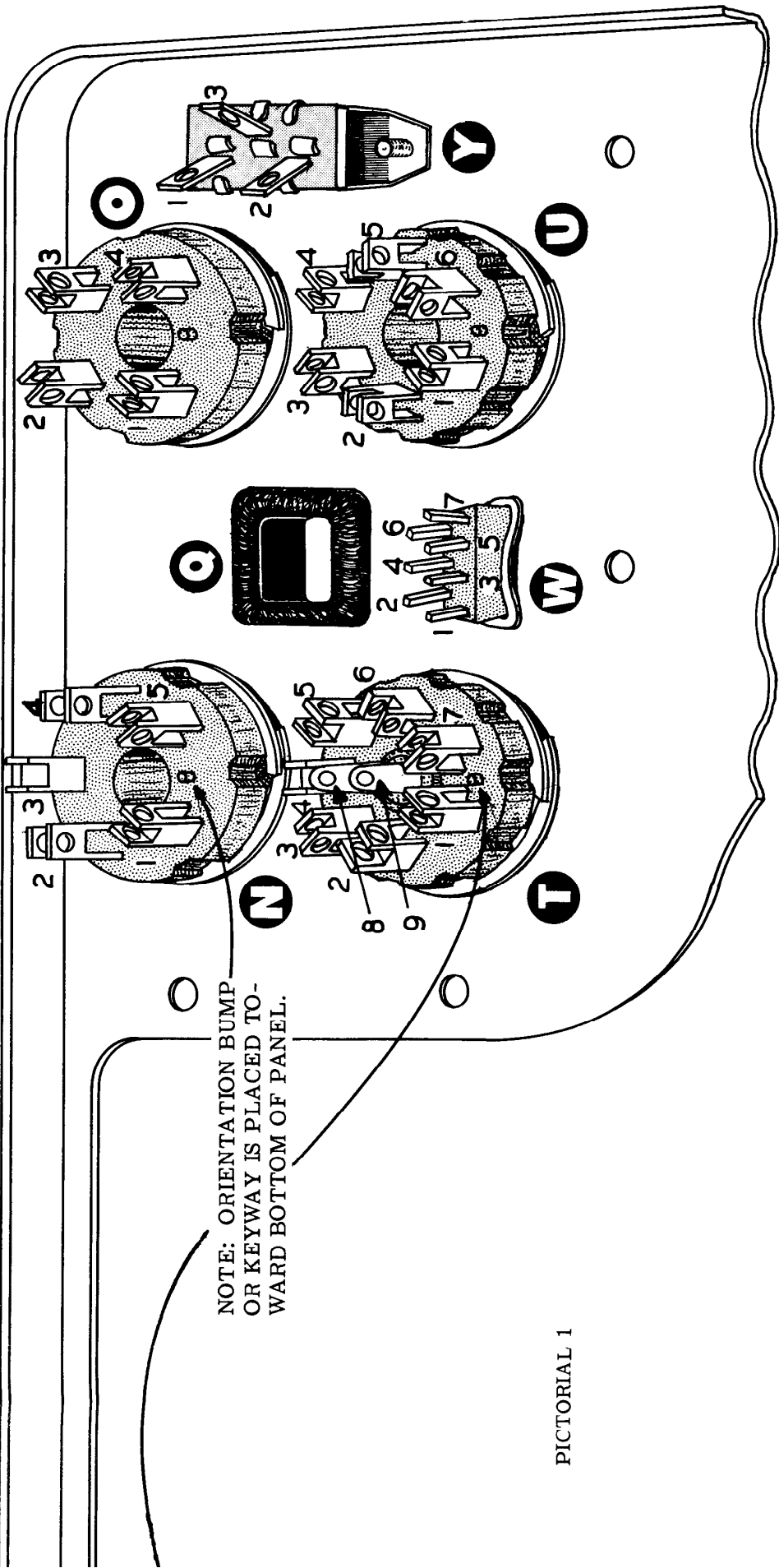

PICTORIAL 1

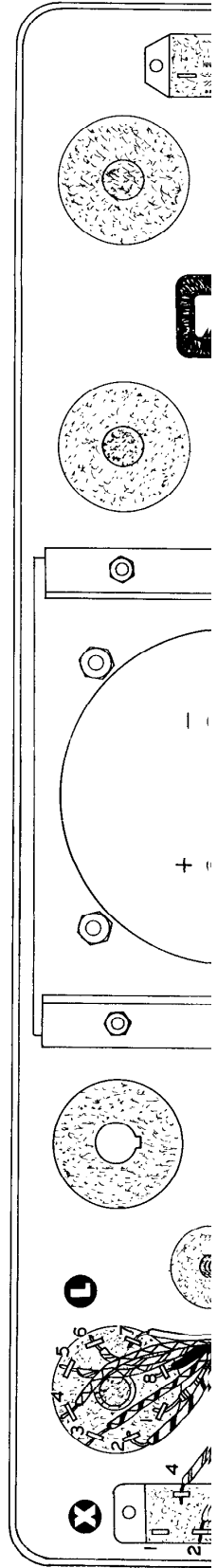

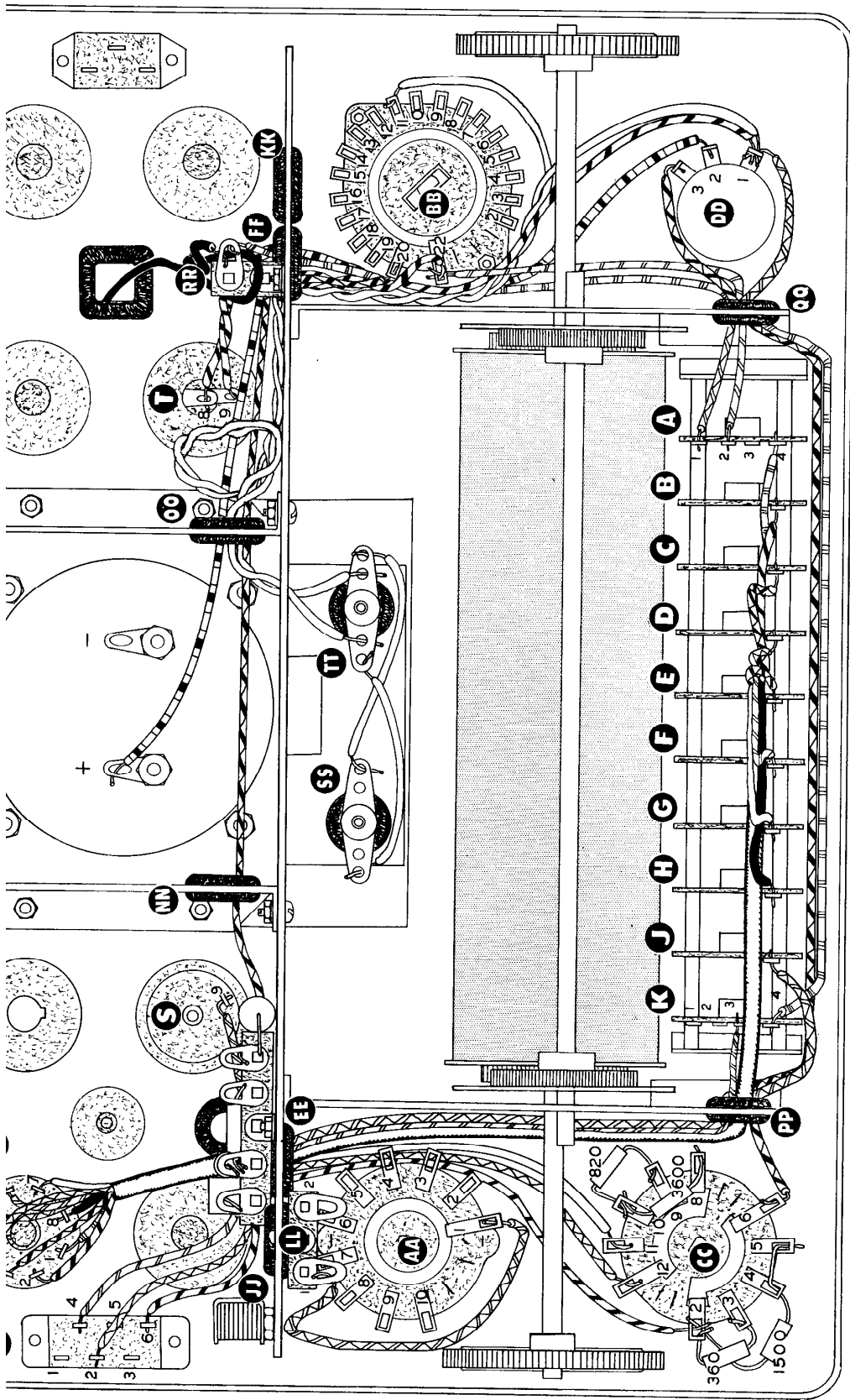

PICTORIAL 5

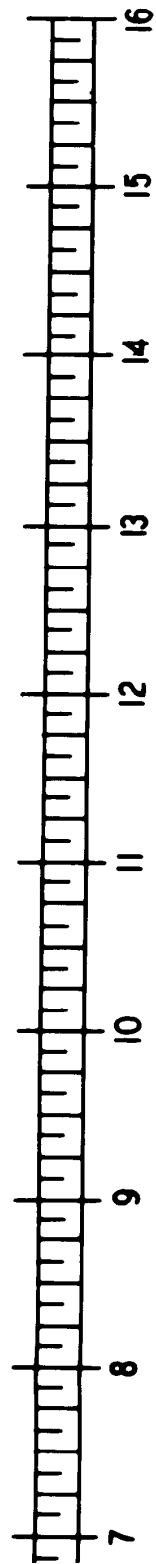

MODEL TC-3

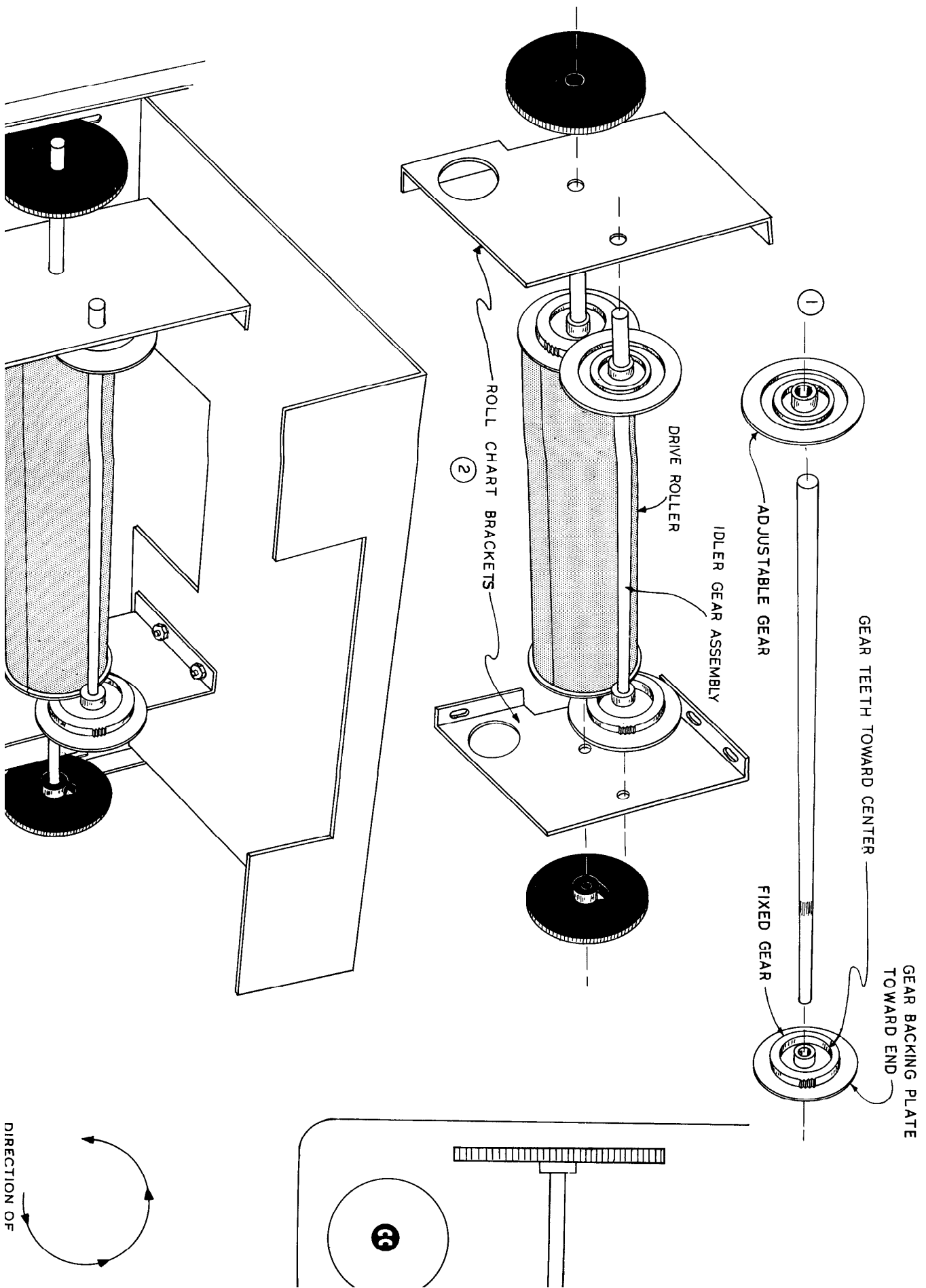

JACKING PLATE
RD END

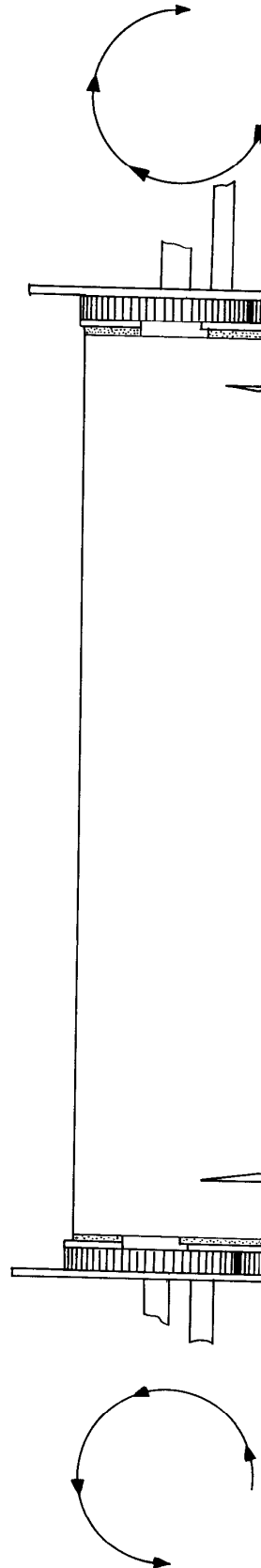
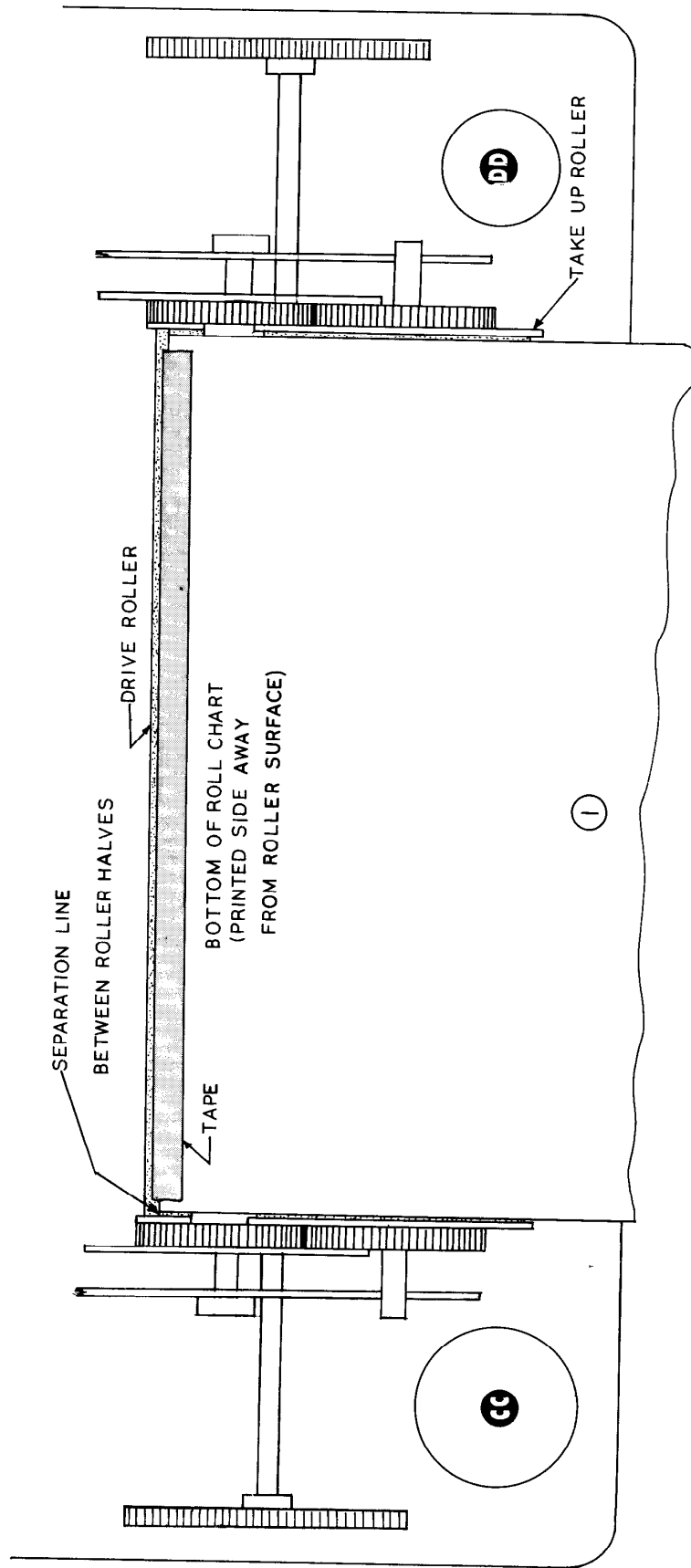
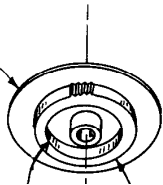

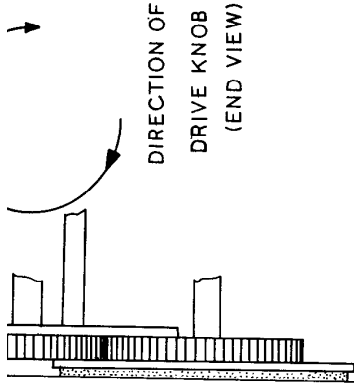

DIRECTION OF ROLL CHART

②

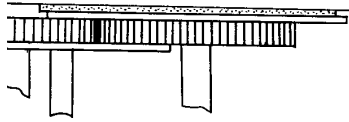

DIRECTION OF DRIVE KNOB (END VIEW)

NOTE: TAKE UP ROLLER IS TOWARD CHASSIS FOR STEP ③

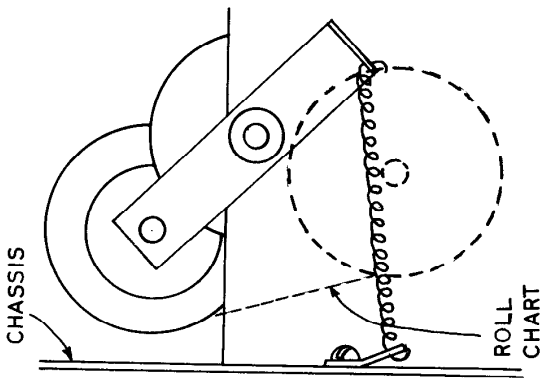
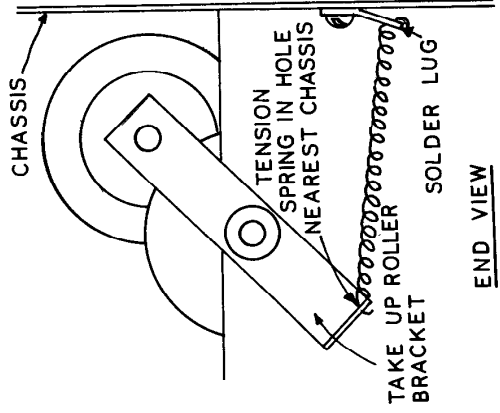
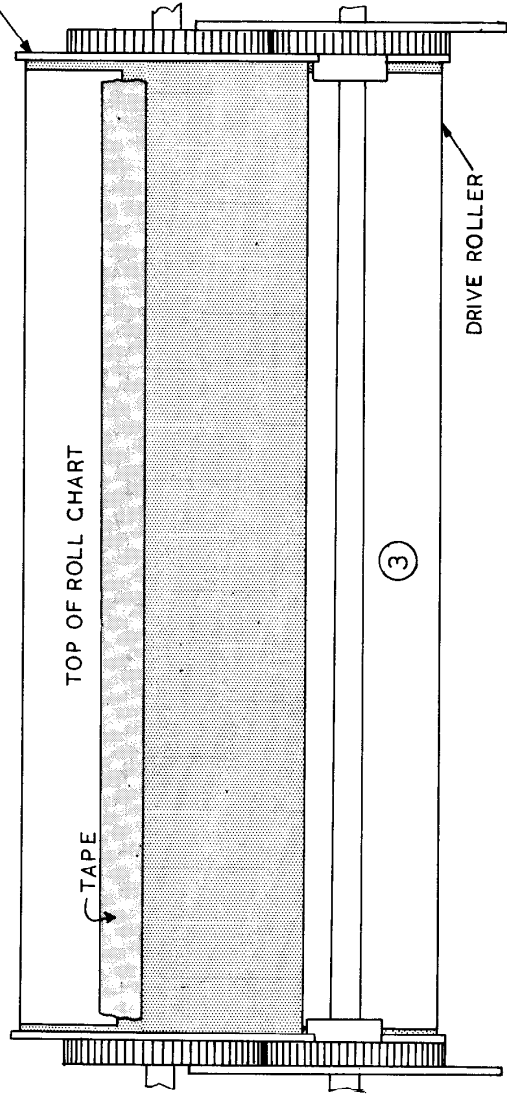
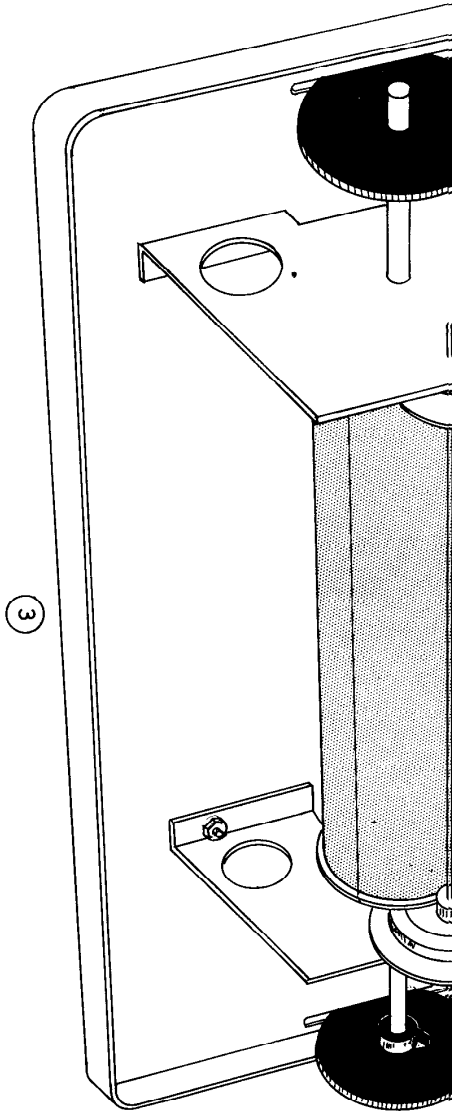
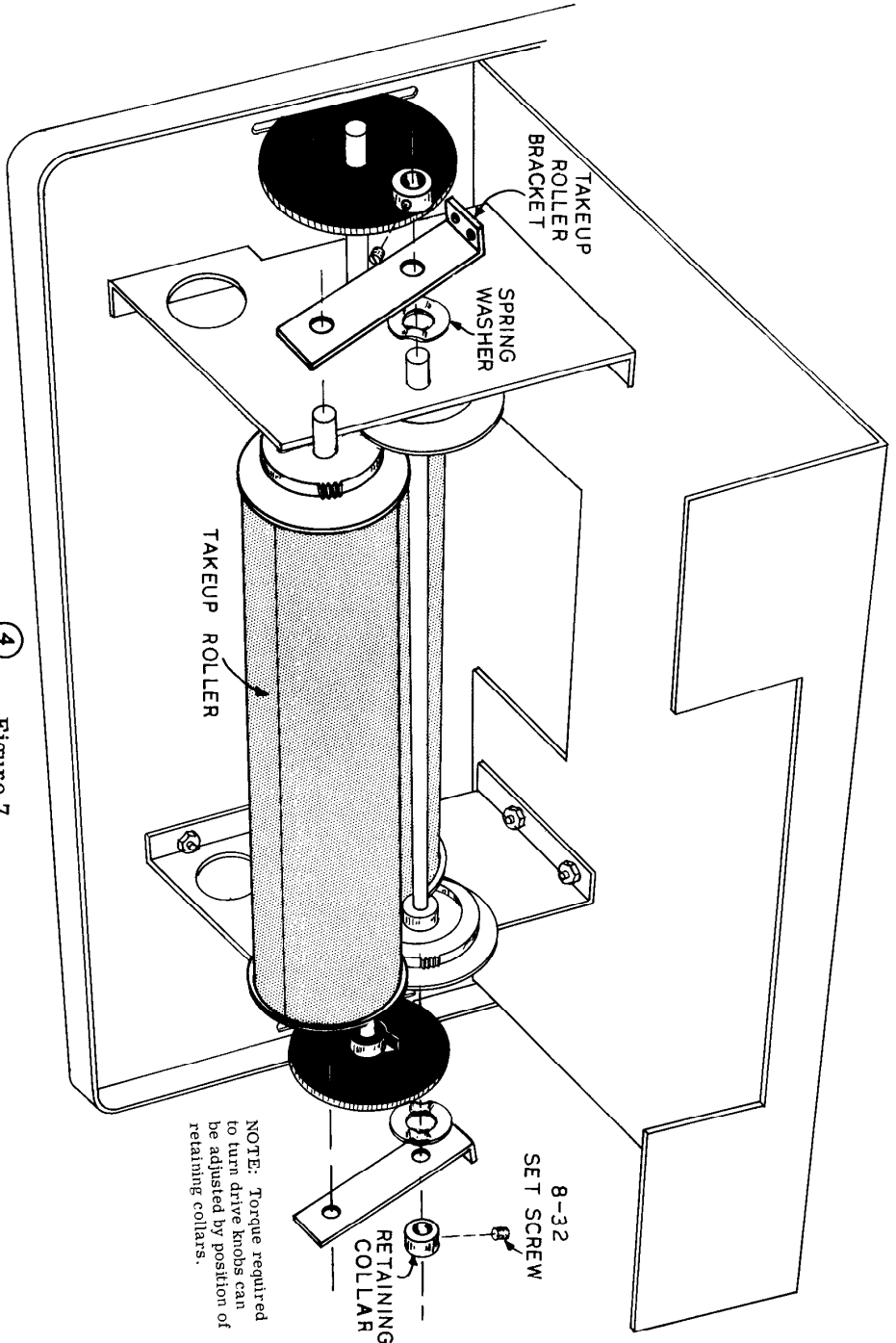

Figure 10



3

DIRECTION OF
DRIVE KNOB
(END VIEW)



4

Figure 7

