

# HEATHKIT

## MODEL V-4

# VACUUM TUBE VOLTMETER

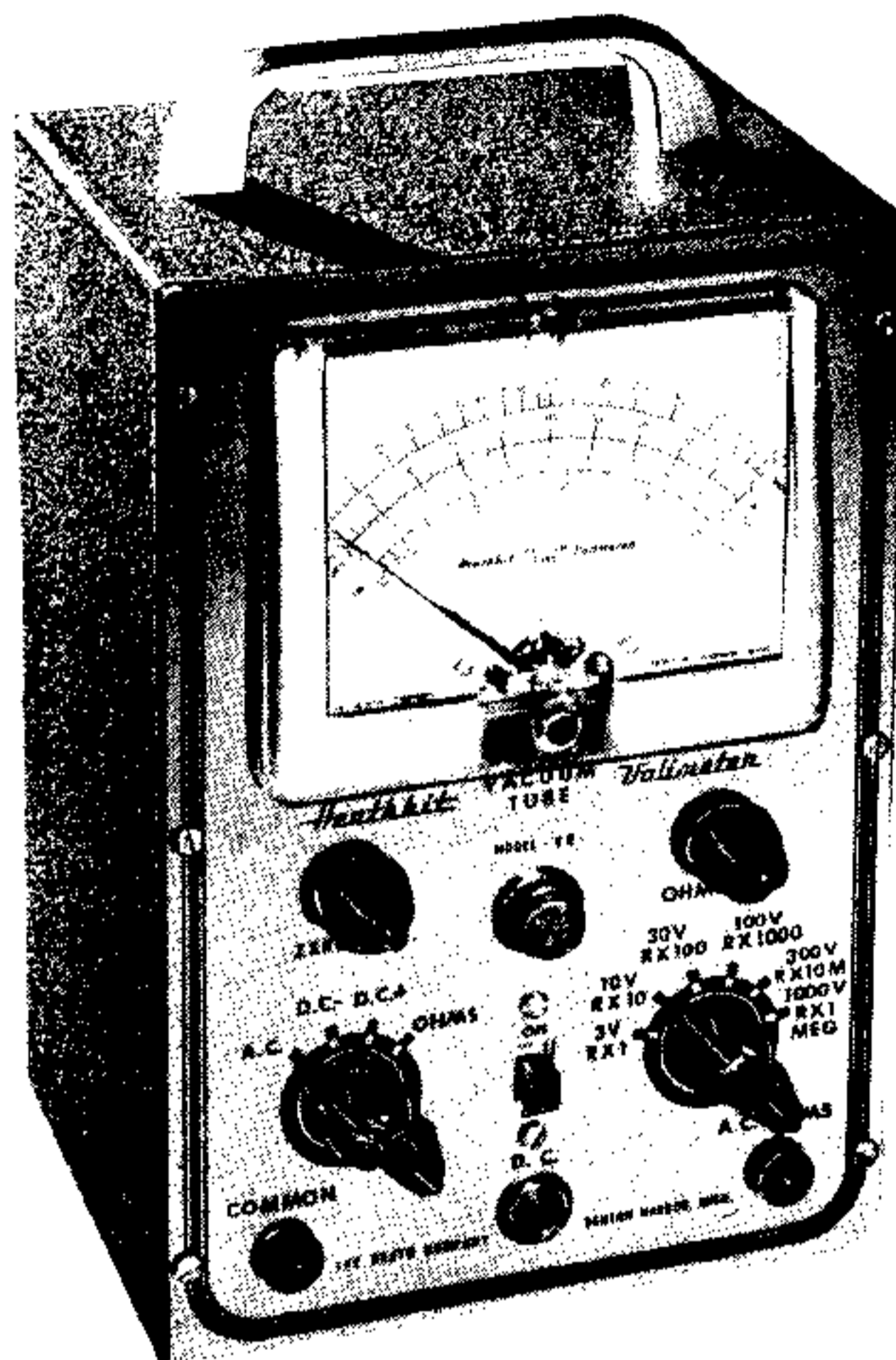

### SPECIFICATIONS

Power Requirements: . . . . .	105-125V 50/60 Cycle AC, 10 Watts.
Overall Size: . . . . .	10" high x 6" wide x 5 <sup>7</sup> / <sub>8</sub> " deep.
Kit Shipping Weight: . . . . .	8 pounds
Meter: . . . . .	4 <sup>1</sup> / <sub>2</sub> " Streamlined case with 200 microampere movement.
Multipliers: . . . . .	Carbofilm precision type--1% tolerance.
Tubes: . . . . .	1 - 6SN7 Twin triode meter bridge. 1 - 6H6 Twin diode AC rectifier.
Power Supply: . . . . .	Power transformer and selenium rectifier.
Batteries: . . . . .	2- 1 <sup>1</sup> / <sub>2</sub> Volt standard flashlight cells.
D. C. Voltmeter: 6 Ranges: . . . . .	0-3, 10, 30, 100, 300, 1,000 volts full scale. With accessory probe to 3,000 and 10,000 Volts.
Input Resistance: . . . . .	11 megohms (1 megohm in probe) on all ranges. 110 megohms with accessory probe.
Sensitivity: . . . . .	3,666,666 ohms per volt on 3 Volt range.
Circuit: . . . . .	Balanced bridge (push-pull) using twin triode.
Electronic AC Voltmeter: 6 Ranges: . . . . .	0-3, 10, 30, 100, 300, 1,000 Volts full scale on linear scales reading R. M. S. (.707 of negative peak).
Circuit: . . . . .	Diode with adjustable compensation.
Electronic Ohmmeter: 6 Ranges: . . . . .	Scale with 10 ohms center x1, x10, x100, x1,000, x10M, x1 Meg. Measures .1 ohm to 1,000 megohms with internal battery.

# ASSEMBLY OF THE HEATHKIT

## MODEL V-4

# VACUUM TUBE VOLTMETER

It is not difficult to construct this instrument if the instructions are carefully followed. Do not rush the construction. Take time to do a first class job to insure years of troublefree operation. Hurried work increases the chances of mistakes and subsequent difficulties. **THEREFORE READ THIS MANUAL FULLY THROUGH BEFORE STARTING THE ASSEMBLY.**

Begin by checking the parts against the parts list. Identify each part, using the charts on the inside of the cover of this manual where necessary. Thus, you will avoid throwing away any small parts with the packing.

Familiarize yourself with the layout by studying the pictorial diagram and the photo prints. Then proceed by following the step-by-step assembly instructions.

Read the note on soldering on the inside of the back cover. Make a good mechanical joint of each connection with clean metal to clean metal. Use only good quality rosin core radio type solder. Pastes or acids are difficult to remove and minute amounts left combine with moisture from the air forming a corrosive product. Weeks or months later corrosion may result in untimely failure. This corrosive product is also a fairly good conductor and may cause short circuits which damage the meter.

**NOTE: ALL GUARANTEES ARE VOIDED AND WE WILL NOT REPAIR OR SERVICE INSTRUMENTS IN WHICH ACID CORE SOLDER OR PASTES ARE USED.**

Small changes in parts may be made by the Heath Company. All parts supplied will work just as well as the part for which it was substituted. All substitutions will be of equal or better quality than the original, and will be made in order that a minimum delay will occur in filling your order. The precision resistors are marked with K = 1,000 and M = 1,000,000. Thus, a resistor marked 90K = 90,000 ohms and one marked 9.9M = 9,900,000 ohms or 9.9 megohms.

The chassis and panel are wired separately as far as possible. Then they are fastened together and the wiring is completed.

### STEP BY STEP ASSEMBLY

(S) means solder the connection      (NS) means do not solder yet

1. Fasten the tube sockets (O54) with socket rings (O43) to the chassis (V52B) with the keyways towards the nearest edge of the chassis. The end of the ring can be held in the groove in the socket and the rest of the ring can then be forced over the socket and into the groove with a screwdriver. Mount the two calibrating controls (V24) with a control nut and a control lockwasher between control and chassis. Temporarily mount the zero adjust control (V63) and the ohms adjust control (V25) with a control nut and a control lockwasher between control and chassis. Mount the AC balance control (V99) with a control nut and a control lockwasher between control and chassis.

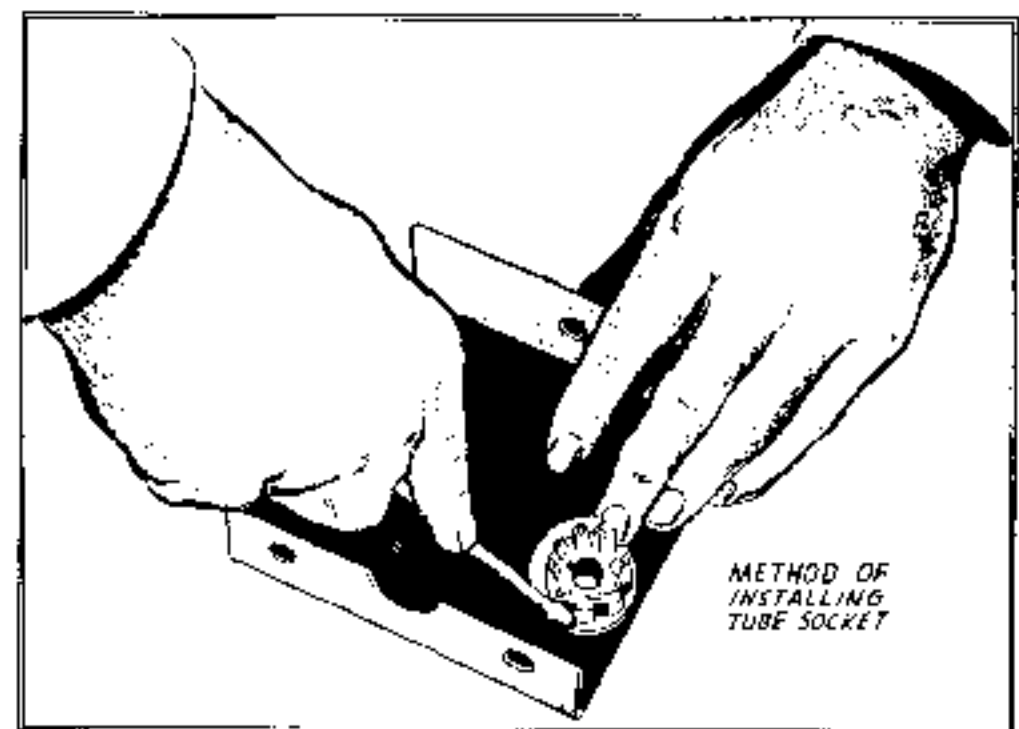

2. Install the three  $\frac{3}{8}$  rubber grommets (O35) in the chassis holes provided. Mount the power transformer with the two leads through the grommet near the front and the four leads through the grommet near the rear of the chassis. Between the tube sockets, use a 6-32 x  $\frac{3}{8}$  screw with a single terminal strip (O38) and a solder lug under the nut. On the other side, use a 6-32 x 1 screw, and place the selenium rectifier (V97) and a lockwasher under the nut.

3. Cut transformer leads to length and connect as follows: One yellow lead to solder lug (NS) between tube sockets. Other yellow lead to pin #7 on 6H6 socket (NS). One red lead to single terminal strip (NS). Other red lead to lug on selenium rectifier nearest chassis (S). A bare wire through pin #1 (S) #2 (S) #4 (NS) and #5 (NS) on 6H6 socket. A bare wire to pin #4 (NS) on 6H6 socket and to solder lug (NS). A bare wire to pin #8 (NS) on 6SN7 socket and to solder lug (S). A wire to pin #7 on 6H6 socket (S), and to pin #7 on 6SN7 socket (NS). A wire to lug on selenium rectifier farthest from chassis (NS) and through pin #5 (S) to pin #2 (NS) on 6SN7 socket.
4. A .003 condenser (V26) to pin #4 on 6H6 socket (S), and with spaghetti over the lead to pin #4 on 6SN7 socket (NS). A 470K resistor (O18) to pin #8 (S) and pin #6 (NS) on 6H6 socket. A 10 meg resistor (C10) to pin #5 (S) and to pin #3 (NS). A 20K resistor (V22) to single terminal lug (NS), and to pin #8 on 6SN7 socket (NS). A 3.3 meg resistor (O10) to pin #1 (S) and pin #8 (NS) on 6SN7 socket. A 15K resistor (V23) to pin #8 (S) and to pin #2 (S) on 6SN7 socket.
5. A 2K Resistor (O15) to pin #3 on 6SN7 socket (NS) and with spaghetti over the lead to lower terminal of zero adjust control (S). A 2K resistor (O15) with spaghetti over both leads to upper terminal of zero adjust control (S) and to pin #6 on 6SN7 socket (NS). A 47K resistor (A10) with spaghetti over both leads to center terminal of zero adjust control (S) and to single terminal strip (NS). A 5600 resistor (G12) to inward terminal of DC calibrate control (S), and to pin #6 on 6SN7 socket (NS). A wire to inward terminal of AC calibrate control (S) and to pin #6 on 6SN7 socket (S). A wire to center terminal of ohms adjust control (S) and to center terminal of DC calibrate control (NS). A 12 MFD condenser (V27) with positive lead to lug on selenium rectifier farthest from chassis (S) and with negative lead to single terminal strip (S).

6. Assemble battery bracket as shown and mount on the chassis with the triple terminal strip and a solder lug under the nut. A black transformer lead to lower lug (nearest chassis) on terminal strip (NS). A wire to pin #6 on 6H6 socket (S) and to outside terminal of AC balance control (S). A wire to pin #3 (NS) on 6H6 socket and to middle lug on terminal strip (NS). A .01-1,000V condenser (O24) to center terminal of AC balance control (NS) and through solder lug (S) to battery bracket terminal nearest rear edge of chassis (S). Two 1 meg resistors (O17) to center terminal of AC balance control (S), one to middle lug (S) and other to upper lug (NS) on terminal strip.

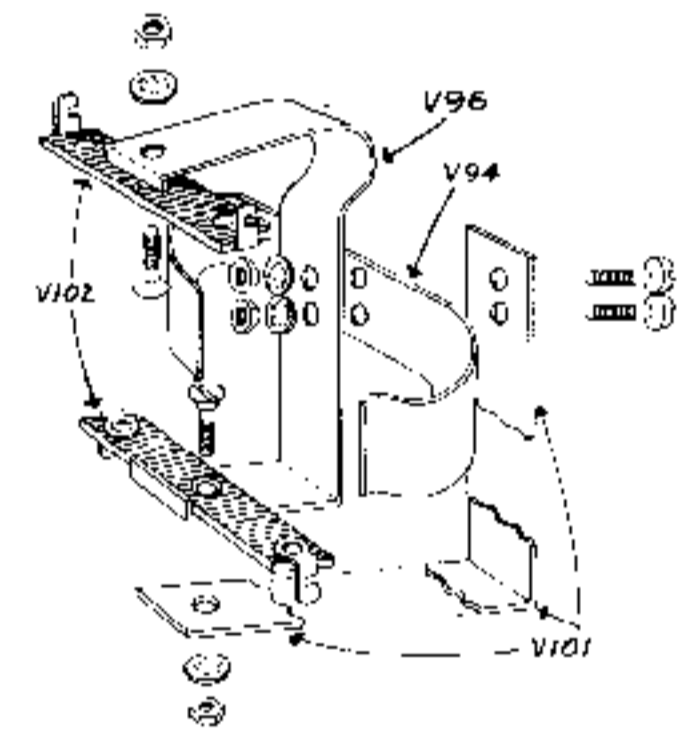

7. On the panel (V51C), mount the pilot light assembly (O39, O40, O41, O42, O52) with the bracket toward the slide switch opening. Mount the slide switch (O94) with 6-32 screws and nuts. Mount the banana jacks with speednuts (O44), the black jack (V77B) in the hole marked common and the red jack (V77R) in the hole marked AC Ohms. Push the banana jack inserts (M28) into the jacks from the front of the panel as far as they will go. Mount the phone jack (K17) with a control nut using a control lockwasher between jack and panel and a nickel washer between panel and nut. Mount the range switch (V75) to the panel with a control nut, using a lockwasher between switch and panel and a nickel washer between panel and nut. Tighten nut partly. Temporarily install a pointer knob. Turn switch counterclockwise as far as it will go. Now turn the whole switch so the knob points at 3V - Rx1. Carefully remove knob and tighten nut.

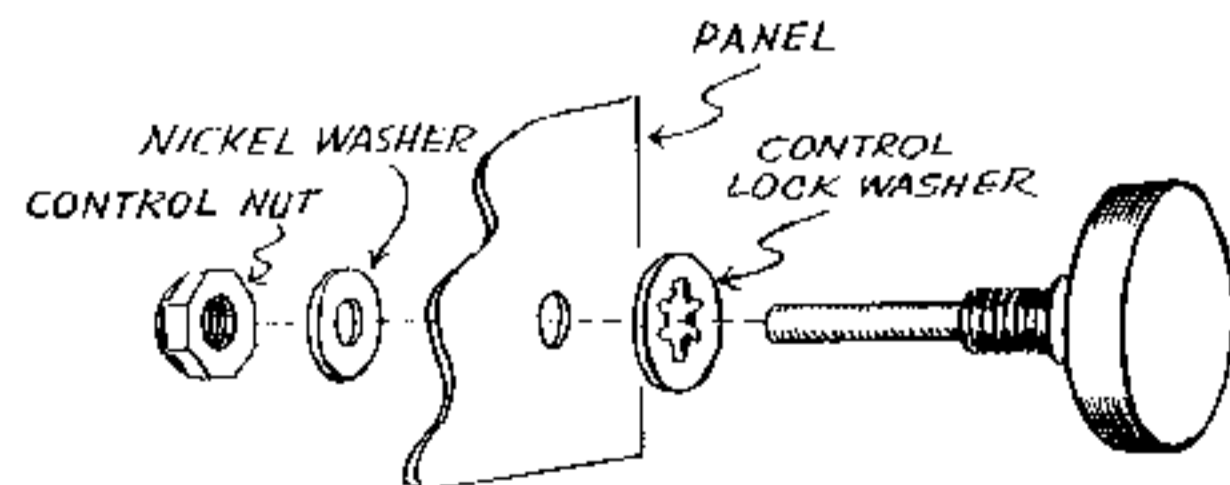
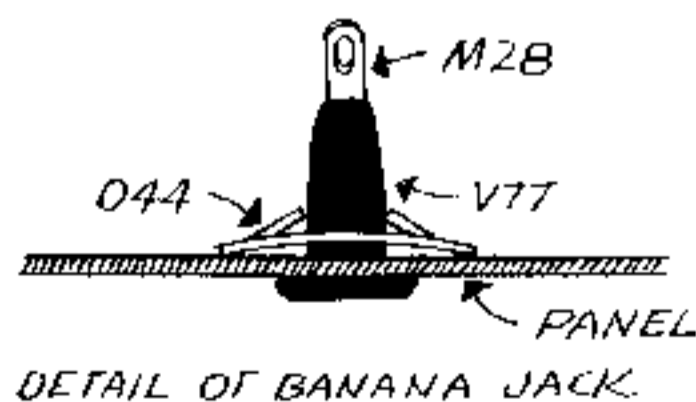

8. Wire the range switch by mounting the multiplier resistors (V103, V73, V74, V68, V66, V65, V69, V64, V76, V71, V72 and V70) as shown in the pictorials. Note that the 30K resistor (V66) connects to the grounded lug on the phone jack. The 8.3 resistor (V103) is soldered to the switch without shortening the lead, after slipping on a piece of spaghetti. The other side is connected later.

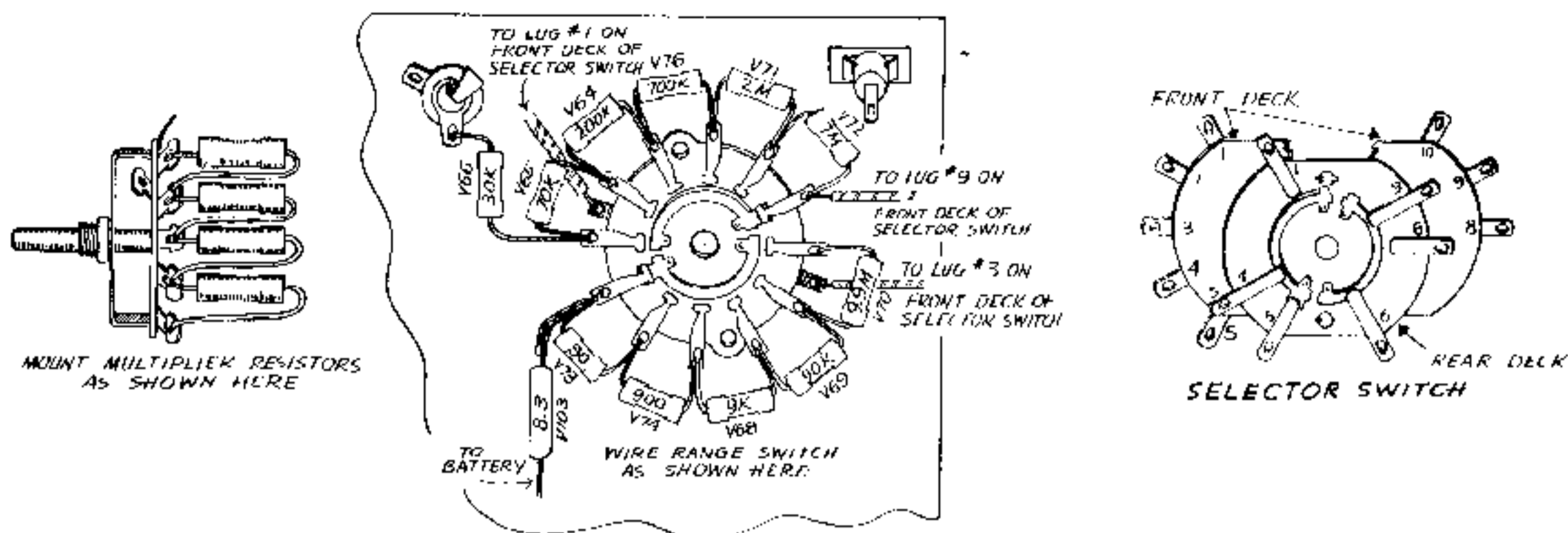

9. Install the selector switch (V28A) with a control nut, using a control lockwasher between switch and panel and a nickel washer between nut and panel. Make sure this switch is mounted as shown in the pictorial. A bare wire to black banana jack (S) and to ground lug on phone jack (S). A bare wire to one lug on pilot light (S) and to pilot light bracket (S).
10. A wire to front outside lug on range switch (S) and to lug #3 on front deck of selector switch (S). A wire to lug on range switch to which 7 meg resistor is connected (S) and to lug #9 on front deck (nearest panel) of selector switch (S). A wire to front inside lug on range switch (S) and to lug #1 on front deck of selector switch (S). A bare wire to insulated contact on phone jack (S) and to lug #10 on front deck of selector switch. A wire to red banana jack (S) and to lug #5 on front deck of selector switch (S).
11. Mount the meter (V49C) on the panel with the hardware provided on the meter. Loosen the nuts on the zero adjust and ohms adjust controls on the chassis. Slip the panel over the bushings of these controls and replace the nuts using a nickel washer between nut and panel. A wire to pin #7 on 6SN7 socket (S) and to lug on pilot light socket (S). A wire to lug #8 on front deck of selector switch (S) and to upper lug on triple terminal strip (S). A wire to lug #8 on rear deck (farthest from panel) of selector switch (S) and to nearest terminal of ohms adjust control (S). A wire to lug #1 on rear deck of selector switch (S) and to center terminal of DC calibrate control (S). A bare wire to lug #6 on rear deck of selector switch (S) and to pin #3 on 6SN7 socket (S). A wire to lug #5 on rear deck of selector switch (S) and to center terminal of AC calibrate control (S). Slip spaghetti over the lead on the 8.3 resistor from the range switch and connect to nearest lug of battery bracket (S).
12. A 3.3 meg resistor (O10) with spaghetti over both leads to lug #2 on front deck of selector switch (S) and to pin #4 on 6SN7 socket (S). A .01 MFD-2,000V condenser (V79) with spaghetti over both leads to lug #4 on front deck of selector switch (S) and to pin #3 on 6H6 socket (S). A wire to lug #9 on rear deck of selector switch (S) and through nearest grommet in chassis to meter terminal nearest AC balance control (S). A wire to lug #4 on rear deck of selector switch (S) and through nearest grommet in chassis to meter terminal nearest tube sockets (S). The remaining black transformer lead to upper lug on slide switch (S). Place the line cord (O78) through the grommet in the rear of the chassis. Tie a knot for strain relief and one lead to lower lug on slide switch (S), other lead to lower lug on triple terminal strip (S). A wire between the top lugs on the battery bracket (S).
13. Make up the test leads: The common lead is black test lead (V45) with a black banana plug (V39) on one end and an alligator clip (V44) on the other end. The AC ohms lead is red test lead (V46) with a red banana plug (V40) on one end and a red test prod (V42) on the other end. The DC lead is shielded test lead (V47) with a phone plug (V41) on one end and a small 1 meg resistor (V56) inside the black test prod (V43). Prepare the cabinet (V33) by installing the handle (O79) with 10-24 screws and by pushing the rubber feet (O34) into the holes in the bottom. Install the acorn knobs (V48) on the adjust controls, and the pointer knobs (O51) on the switches.

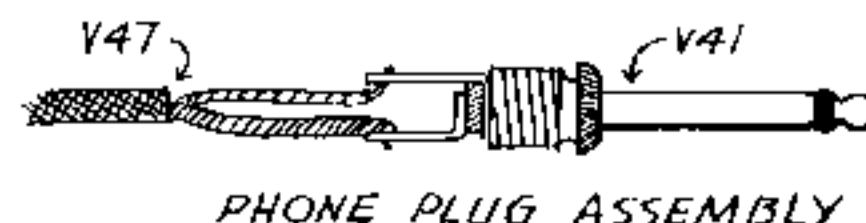
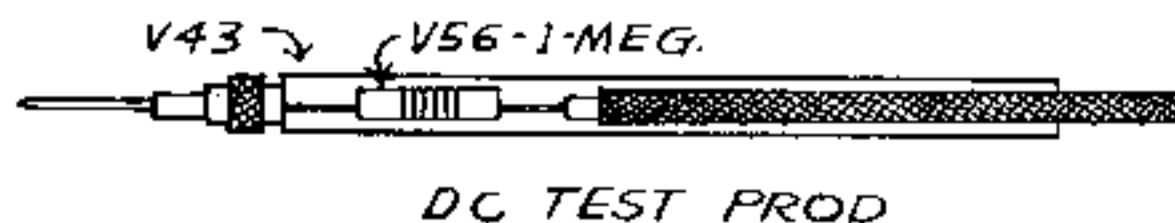
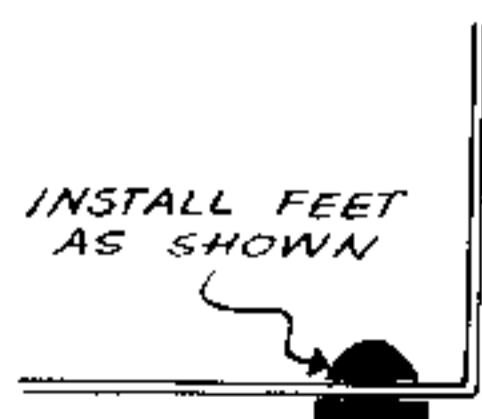

## TEST AND CALIBRATION

Check the wiring over carefully. We suggest tracing over each wire on the pictorial with a colored pencil as it is checked on the instrument. Check each solder connection. Install the tubes.

Plug into a 117 Volt 50/60 Cycle AC ONLY outlet. This instrument will not operate and serious damage will result if connected to DC.

Turn switch on and allow a minute for warm up. Set selector to DC +. Check operation of zero adjust control. Turning this control should move the meter pointer to about half scale and to zero. Set pointer to zero and check if it remains on zero when switched to DC -. If there is appreciable zero shift (more than one division on the scale) the tubes must be aged. First complete the initial test, however.

Insert the common and DC test leads. Set the selector switch to DC + and the range switch to 3V. Connect the calibrated flashlight cell and adjust the DC calibrate control so the meter pointer indicates the calibration voltage on the 3V scale.

Install the batteries in the battery bracket as shown. Set selector switch to ohms. Pointer should swing to about full scale. Turn ohms adjust to give full scale reading (INFinite). Insert AC ohms test lead. Touch this lead to common lead and observe pointer dropping to zero indication short circuit (no resistance).

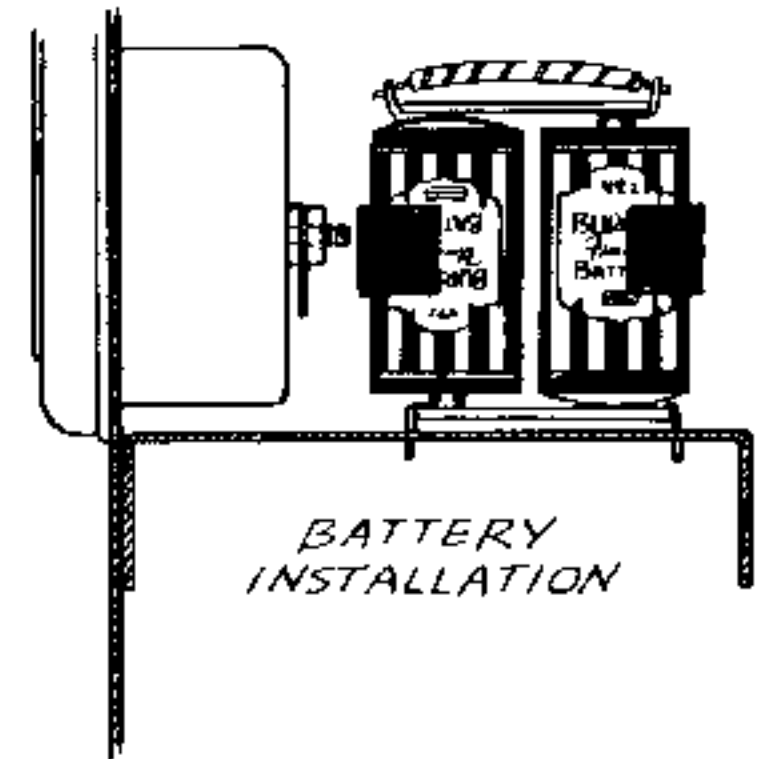

Temporarily remove AC ohms test lead. Set range switch to 3V and selector to AC. Adjust AC balance control so no movement is noticed in the pointer when switching from AC through DC - to DC +. Now set range switch to 300V. Re-insert AC ohms lead. Connect AC ohms and common lead to the 117V AC line (NOTE: 117 Volt line is dangerous-- proceed with due care) and adjust AC calibrate control so pointer indicates the line voltage.

It is recommended that the tubes be aged before final calibration. This is accomplished by keeping the instrument turned on for a period of at least 48 hours. Final calibration should be done in the same way as the initial calibration. Careful calibration will result in a more accurate instrument. If a standard AC meter is available, it is desirable to use such instrument, preferably at a voltage near full scale indication on the VTVM, as for instance 250 Volt or 90 Volt (on the 300V or 100V scale respectively).

After final calibration, install the instrument in the cabinet with sheet metal screws through the panel and in the rear into the chassis. This completes the instrument.

## CIRCUIT DESCRIPTION

This instrument uses a balanced vacuum tube circuit to increase the sensitivity and provide greater flexibility. The relationship between the test voltage applied to the tube and the indicating meter current is linear over a range appreciably greater than the operating range. When a much larger test voltage is accidentally applied, the relationship ceases to be linear and the indicating meter current is limited to a value of a few times full scale current. This makes the meter, when used in this circuit, virtually burn out proof. Repeated overloads should be avoided, however, as the pointer may be bent.

The zero adjust control balances the currents through the tubes and permits the meter to be set to zero, or partly up scale.

The calibration controls are in series with the meter and are adjusted to produce full scale reading with the proper test voltage applied to the instrument. The maximum test voltage applied to the tube is about 3 Volts. Higher test voltages are reduced by a voltage divider with a total resistance of 10 megohms. An additional resistor of 1 megohm is located in the DC test prod, which permits measurements to be made in circuits carrying R. F. with minimum disturbance of such circuits.

For AC voltages in the Audio Frequency range, a shunt fed diode is used to provide a DC voltage proportional to the peak of the applied AC voltage. This DC voltage is applied through the voltage divider to the tube, causing the meter to indicate. The AC calibrate control is used to get the proper meter deflection for the applied AC voltage. Vacuum tubes develop a contact potential voltage between tube elements. Such contact potential developed in the diode would cause a slight voltage to be present at all times. This voltage is cancelled out by bucking it with a portion of the contact potential of a second diode. The amount of bucking voltage is controlled by the AC balance control. This eliminates zero shift when switching from DC to AC.

For resistance measurements, a 3 Volt battery is connected through a string of multipliers to the tube. The external resistance to be tested is connected between tube and common (chassis), forming, together with the multipliers, a voltage divider across the battery. The resultant portion of the battery voltage is thus applied to the tube causing the meter to deflect. The meter scale is calibrated in resistance.

The operating power for the tube is obtained from a power supply using a power transformer, a half wave selenium rectifier, a filter condenser and a voltage divider.

### USING THE VTVM

The VTVM has many advantages over the non-electronic volt-ohmmeters. The greatest advantage is the high input resistance. This enables much more accurate readings to be obtained in high impedance circuits, such as resistance coupled amplifiers, oscillator grid circuits and AVC networks.

To illustrate this, let us assume a resistance coupled audio amplifier with a .5 megohm plate load resistor, operating with a 100 Volt plate supply. Let us also assume that the tube acts as a .5 megohm resistor. Measuring the plate voltage with a conventional 1,000 ohm per volt instrument on the 100 Volt scale, the meter can be considered a 100,000 ohm (.1 megohm) resistor in parallel with the tube. The voltage on the plate is then about 14 Volts and is shown as such by the meter. This is due to the shunt resistance of the low resistance meter. Using the VTVM on any scale setting, the full 11 megohm is placed in parallel with the tube. The voltage on the plate is then about 49 Volts or 2% lower than the normal operating voltage. Thus accurate reading can only be obtained with the high resistance provided by a VTVM.

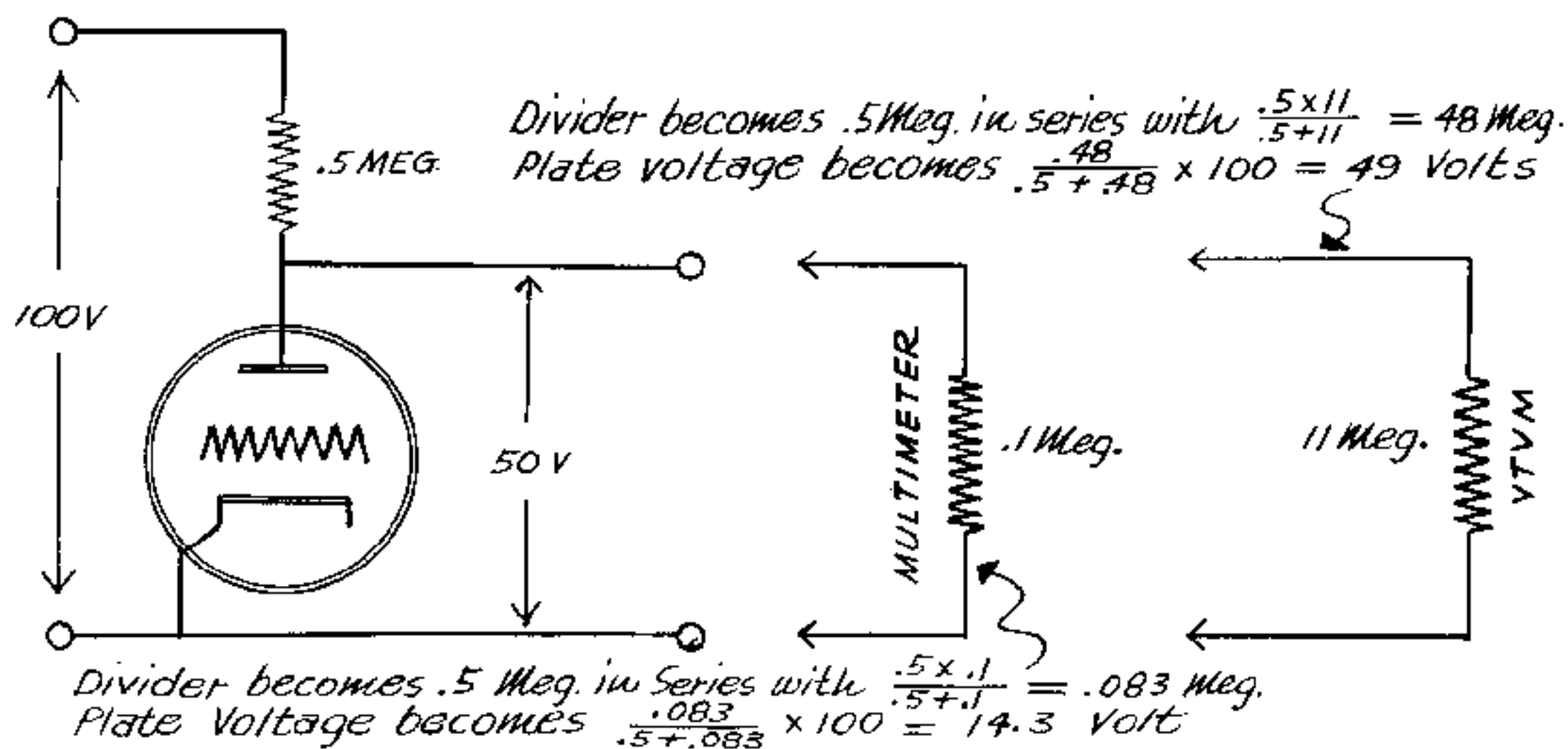

Similar benefits are obtained in AVC, oscillator and other high resistance circuits.

An understanding of the characteristics of your instrument will result in greater satisfaction through proper use.

## DC VOLTAGE

To measure DC voltage with the VTVM, connect the common (black) lead to the common or "cold" side of the voltage to be measured. Set the selector switch to DC + or DC - as required, and set the range switch to a range greater than the voltage to be measured, if known. If unknown, set to 1,000 Volts. With black test prod, touch other or "hot" side of the voltage to be measured. If pointer moves less than one-third of full scale, switch to the next lower range.

## AC VOLTAGE

To measure AC voltages with the VTVM, connect the common (black) lead to the common or "cold" side of the voltage to be measured. Set the selector switch to AC, and set the range switch to a range greater than the voltage to be measured, if known. If unknown, set to 1,000 Volts. With red test prod, touch other or "hot" side of the voltage to be measured. If pointer moves less than one-third of full scale, switch to the next lower range.

The Heathkit is an extremely sensitive electronic AC voltmeter and as the human body picks up AC when near any AC wires, the meter will indicate this pick up. Never touch the AC prod when on the lower ranges. Zero should be set with the AC prod shorted to the common clip.

## RESISTANCE

To measure resistance with the VTVM, connect the common (black) lead to one side of the resistor to be measured. Set the selector to ohms, and set the range switch to such a range that the reading will fall as near to mid scale as possible. Set the ohms adjust control so the meter indicates exactly full scale (INF. on ohms scale). Then touch the red test prod to the other side of the resistor to be measured. Read resistance on ohms scale and multiply by the proper factor as shown by the range switch setting.

**CAUTION:** Never leave the instrument on ohms, as it greatly shortens the life of the ohmmeter battery.

## USING THE VTVM DECIBEL SCALE

Because the human ear does not respond to volume of sound in proportion to signal strength, a unit of measure called the "bel" was adopted. The "bel" is more nearly equivalent to human ratios. Normally the reading is given in 1/10 of a "bel" or "decibel".

Various signal levels are adopted by various manufacturers as standard or "0" decibels.

The Heathkit VTVM DB scale uses a standard of 6 milliwatts into a 500 ohm line as "0" decibels. This corresponds to 1.73 VAC on the 0-10 scale. From this figure, the various AC ranges of the VTVM may be converted to db by the following chart.

AC VOLTS SCALE	DECIBEL SCALE
0-3V.	Subtract 10 db from reading
0-30V.	Add 10 db to the reading
0-100V.	Add 20 db to the reading
0-300V.	Add 30 db to the reading
0-1000V.	Add 40 db to the reading

As the decibel is a power ratio or voltage ratio, it may be used as such without specifying the reference level. Thus for instance, a fidelity curve may be run on an amplifier by feeding in a signal of variable frequency but constant amplitude. At a reference frequency of say 400 cycles, adjust input to give a convenient indication (0 db for instance) on the VTVM connected to the output. As the input frequency is varied, the output level variation may be noted directly in db above and below the specified reference level.

**NOTE:** When measuring complex AC wave shapes, such as ripple, hum, distorted and square waves, the indication is 70% of the negative peak.

## READING THE METER SCALE

The voltage markings on the range switch refer to the FULL SCALE reading. The scale is marked 0-10 and 0-30 for voltage. On the 3 Volt range, read the 0-30 scale and drop the zero. On the 10 Volt range, read the 0-10 scale direct. On the 30 Volt range, read the 0-30 scale direct. On the 100 Volt range, read the 0-10 scale and add one zero. On the 300 Volt range, read the 0-30 scale and add one zero. On the 1,000 Volt range, read the 0-10 scale and add two zeros.

The resistance marking or ohms scale refers to the lowest resistance range (Rx1). For the other ranges, add the proper number of zeros (add two zeros for Rx100, add four zeros for Rx10M, add six zeros for Rx1 Meg). On the Rx1 Meg range, the scale can also be considered to read directly in megohms.

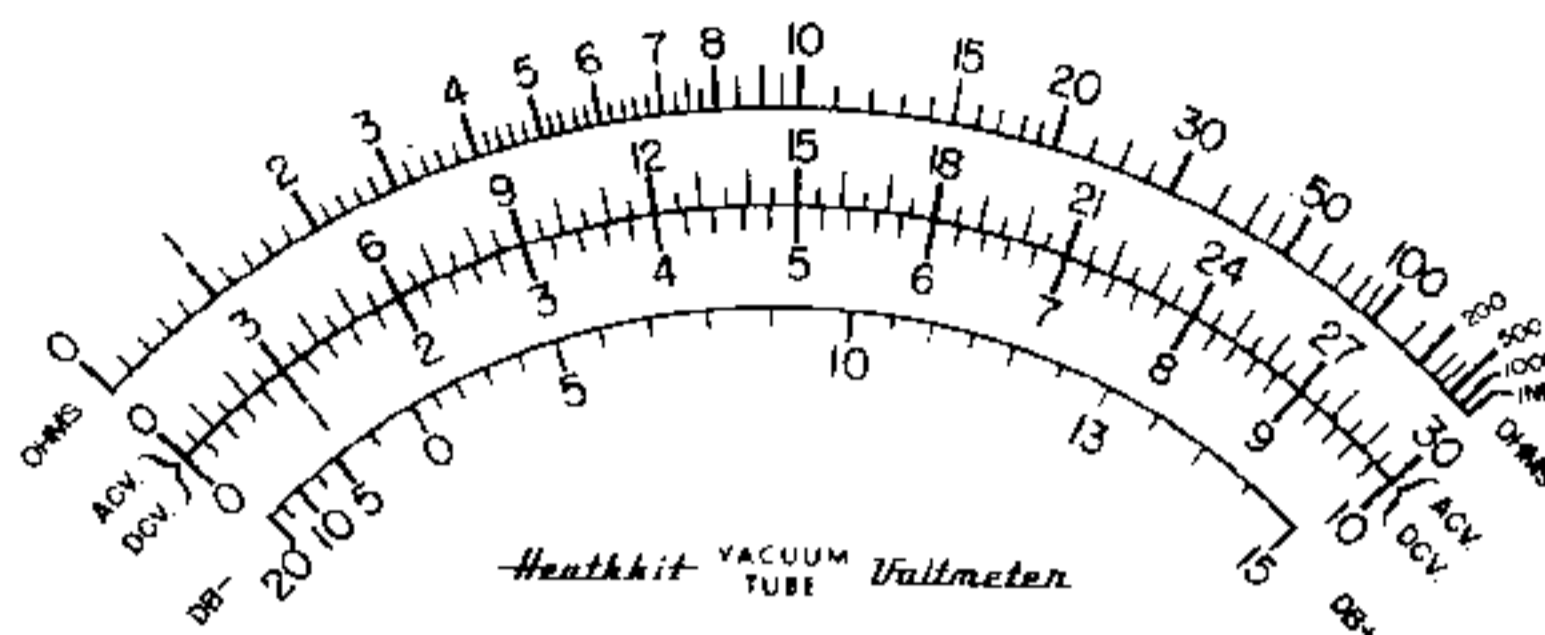

## ACCURACY

The accuracy of most meters is rated at 2% of full scale on DC and 5% of full scale on AC. The Heathkit VTVM easily fulfills these requirements. When comparing with other instruments, consideration should be given to the possibility that the other instruments variation might be the opposite of the Heathkit making a possible variation of 4% on DC and 10% on AC.

## IN CASE OF DIFFICULTY

1. Recheck the wiring. Most cases of trouble result from wrong or reversed connections. Often having a friend check the wiring will reveal a mistake consistently overlooked.
2. Check the tubes.
3. If the pointer swings full scale to the right and stays there with switch set to DC +, check for an open circuit or high resistance connection someplace between the grid pin #4 of the 6SN7 and ground. This might be due to a wrong connection to the selector switches, poor connection or possibly an open resistor.

If the instrument does not operate on any function, a check of the power supply, 6SN7 and its associated meter circuit is suggested.

If the instrument only fails to function on AC measurements, then a check of the 6H6 and its associated circuits is indicated.

If the instrument only fails to function on ohms, the difficulty will probably lie in the batteries or the ohms multipliers.

Proper operation on DC should first be secured before an attempt is made to use the instrument on AC or ohms.

4. Check the operating voltages. The following voltages are measured to chassis: Pin #2 or #5 on 6SN7 tube or + lug on rectifier 40-70 Volts positive. Single terminal strip 60-100 Volts negative. Pin #7 on 6H6 or 6SN7 or "hot" lug on pilot light socket 5-6 Volts AC.
5. Check continuity through DC test cable. Make certain that the shielding is not shorted to center conductor.
6. Write to the Heath Company describing your difficulties and giving all possible details, such as voltages obtained, meter indications if any, model number etc. We will attempt to analyze your trouble and advise you accordingly.



7. If desired, your instrument may be returned to the factory. The Heath Company will check it and put it in operating condition for a charge of \$3.00 plus any parts or alterations required due to damaged or improper construction.

NOTE: Before returning your instrument, make sure all parts are securely mounted, and that all eight screws (including the ones in the rear) holding the instrument in the cabinet are tight. Attach a tag with name, address and trouble experienced to the instrument. Include the test leads. Pack instrument in a rugged container, preferably wood, using at least three inches of shredded newspaper or excelsior on all sides. Do not use folded newspapers. Do not ship in original carton only. Ship by prepaid express if possible. Return shipment will be made by express collect.

NOTE that a carrier cannot be held liable for damage in transit if packing, in HIS opinion, is insufficient.

#### BIBLIOGRAPHY

Many excellent articles on the construction and use of vacuum tube voltmeters have appeared in radio magazines. A few are:

RADIOCRAFT, June, 1945, Electronic Ohmmichecker  
RADIO NEWS, January, 1947, Home Constructed VTVM  
RADIO NEWS, July, 1946, Vacuum Tube Voltmeter  
RADIO NEWS, November, 1945, Electronic Volt-ohmmeter  
RADIO NEWS, February, 1946, Universal Test Instrument  
RADIOCRAFT, May, 1945, Practical VTVM  
VACUUM TUBE VOLTMETERS, A Book by John F. Rider

#### RF TEST PROBE KIT

A test probe in kit form for use in measuring RF voltages of up to about 20 Volts is available for \$6.50. The kit contains all parts necessary for the construction of the probe, including 1N34 crystal detector, condensers, resistor, cable and connectors. This probe and cable is simply plugged into the instrument in place of the regular DC test probe assembly and is read on the lower regular DC ranges.

Order No. 309 RF Test Probe Kit--\$6.50.

#### TELEVISION TEST PROBE KIT

A test probe in kit form for use in testing the high DC voltages in Television receivers up to 10,000 Volts is available for \$4.50. The kit contains all parts necessary for the construction of the probe, including precision multipliers of 1% accuracy, cable and connectors. This probe and cable is simply plugged into the instrument in place of the regular DC test probe assembly and 0-10,000 Volts is read on the 0-10 scale. With range switch set at 300V the full scale indication is 3000 Volts. Order No. 310 TV High Voltage Probe Kit--\$4.50.

Prices subject to change without notice. The Heath Company reserves the right to change the design of its instruments without incurring liability for equipment previously supplied.

#### WARRANTY

The Heath Company limits its warranty on any part supplied with any Heathkit (except tubes, meters, and rectifiers, where the original manufacturer's guarantee only applies) to the replacement within three (3) months of said part which, when returned with prior permission, postpaid, was in the judgment of the Heath Company, defective at the time of sale.

The assembler is urged to follow the instructions exactly as provided. The Heath Company assumes no responsibility for the operation of the completed instrument, nor liability for any damages or injuries sustained in the assembly or operation of the device.

HEATH COMPANY  
Benton Harbor, Michigan

## V-4 VACUUM TUBE VOLTMETER PARTS LIST

Part No.	Parts Per Kit	Description	Part No.	Parts Per Kit	Description
<b>Resistors</b>			<b>Tubes and Lamps</b>		
V103	1	8.3 Ohm Precision	V31	1	6H6 Tube
V73	1	90 Ohm Precision	G44	1	6SN7 Tube
V74	1	900 Ohm Precision	O39	1	#47 Pilot Bulb
V68	1	9,000 Ohm Precision	<b>Wire and Plugs</b>		
V66	1	30,000 Ohm Precision	O77	1	Roll Hookup Wire
V65	1	70,000 Ohm Precision	O81	1	Length Spaghetti
V69	1	90,000 Ohm Precision	V46	1	Length Red Test Lead
V64	1	200,000 Ohm Precision	V45	1	Length Black Test Lead
V76	1	700,000 Ohm Precision	V47	1	Length Shielded Test Lead
V71	1	2 Megohm Precision	O78	1	Line Cord
V72	1	7 Megohm Precision	V40	1	Red Banana Plug
V70	1	9.9 Megohm Precision	V39	1	Black Banana Plug
O15	2	2,000 Ohm	V41	1	Phone Plug
G12	1	5,600 Ohm	V42	1	Red Test Prod
V23	1	15,000 Ohm	V43	1	Black Test Prod
V22	1	20,000 Ohm	V44	1	Alligator Clip
A10	1	47,000 Ohm	<b>Hardware</b>		
O18	1	470,000 Ohm	O31	5	6-32 x $\frac{3}{8}$ Screws
O17	2	1 Megohm	K43	2	6-32 x $\frac{1}{2}$ Flat Head Screws
V56	1	1 Megohm (Small)	IB48	1	6-32 x 1 Screw
O10	2	3.3 Megohm	S22	8	6-32 Nuts
C10	1	10 Megohm	TS72	6	#6 Lock Washers
<b>Condensers</b>			O37	2	Solder Lugs
V26	1	.003 MFD Mica	O102	8	#6 Sheet Metal Screws
O24	1	.01 MFD 1,000V Paper Tubular	O30	2	#10-24 x $\frac{3}{8}$ Handle Screws
V79	1	.01 MFD 2,000V Paper Tubular	O33	8	Control Nuts
V27	1	12 MFD 150V Electrolytic	O101	8	Control Lock Washers
<b>Controls and Switches</b>			O28	5	Control Nickel Washers
V24	2	* 5,000-10,000 Ohm Control (AC and DC Calibrate)	O44	2	Speednuts for Jacks
V25	1	* 5,000-10,000 Ohm Control (Ohms Adjust)	O35	3	$\frac{3}{8}$ Rubber Grommets
V63	1	12,000 Ohm Control (Zero Adjust)	O34	4	Rubber Feet
V99	1	1 Megohm Control (AC Balance)	V94	1	Battery Spring Clip
V28A	1	Selector Switch	V96	1	Battery Spring Bracket
V75	1	2 pole 6 pos. Switch.	V101	1	Stiffener Bracket
O94	1	SPST Slide Switch	<b>Miscellaneous</b>		
<b>Sockets, Terminal Strips and Jacks</b>			V48	2	Acorn Knobs
O54	2	Octal Sockets	O51	2	Pointer Knobs
O43	2	Socket Rings	V49C	1	200 Microamp. Meter
O40	1	Pilot Light Nut	V34	2	Flashlight Cells (one calibrated)
O41	1	Pilot Light Bushing	V97	1	Selenium Rectifier
O42	1	Pilot Light Jewel	V98	1	Power Transformer
O52	1	Pilot Light Socket	V51C	1	Panel
O38	1	Single Terminal Strip	V52B	1	Chassis
SG25	1	Triple Terminal Strip	V53	1	Cabinet
V102	2	Battery Term. Strip Assy.	O79	1	Handle
V77R	1	Banana Jack (red)	V4	1	Manual
V77B	1	Banana Jack (black)			
M28	2	Banana Jack Inserts			
K17	1	Phone Jack			

\* V24 and V25 Controls may be supplied in any value between 5,000 ohm and 10,000 ohm.

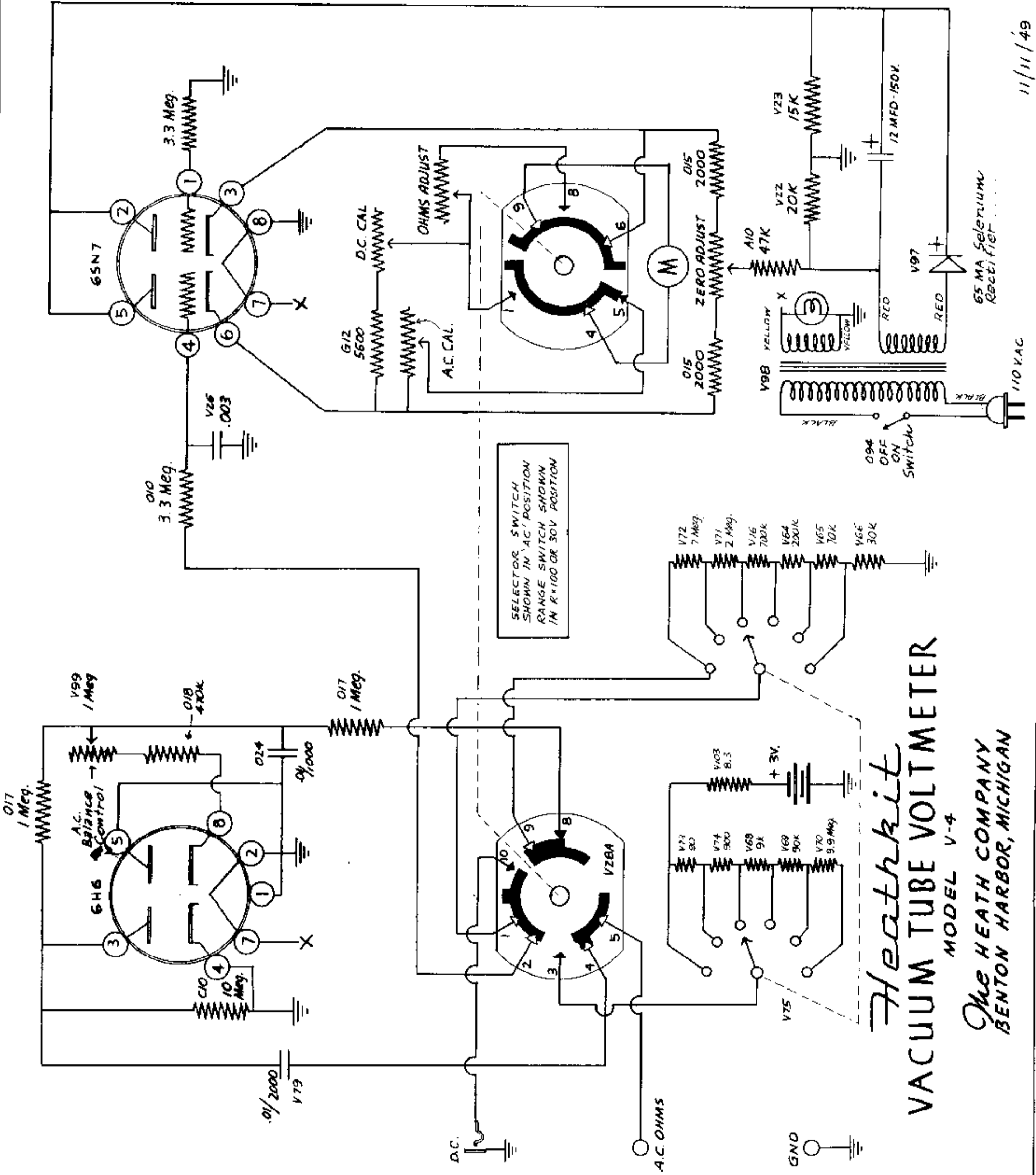

*Heathkit*  
**VACUUM TUBE VOLTMETER**  
 MODEL V-4

*The HEATH COMPANY*  
 BENTON HARBOR, MICHIGAN

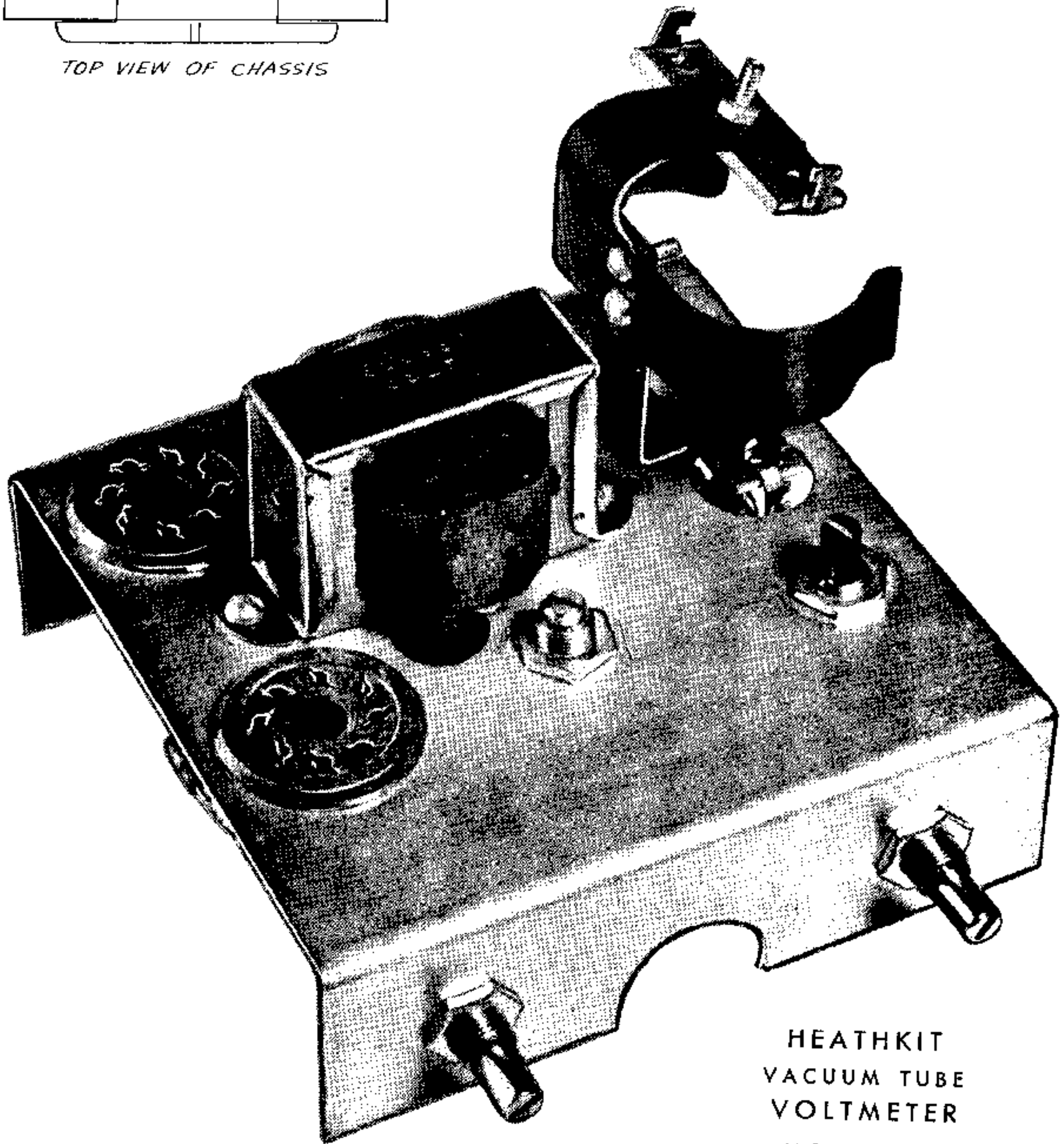
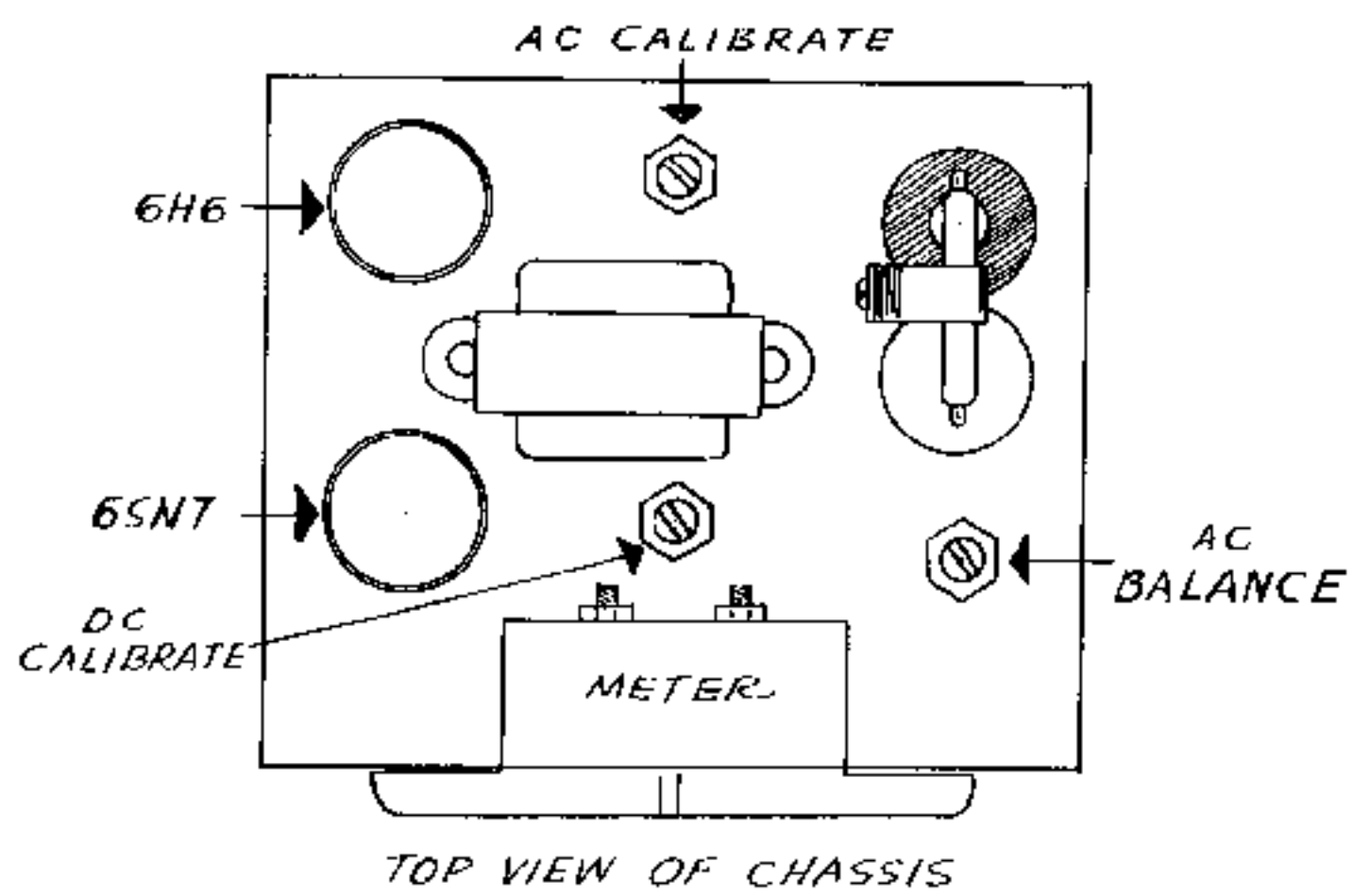

HEATHKIT  
VACUUM TUBE  
VOLTMETER  
MODEL V-4

11/11/49

V59C

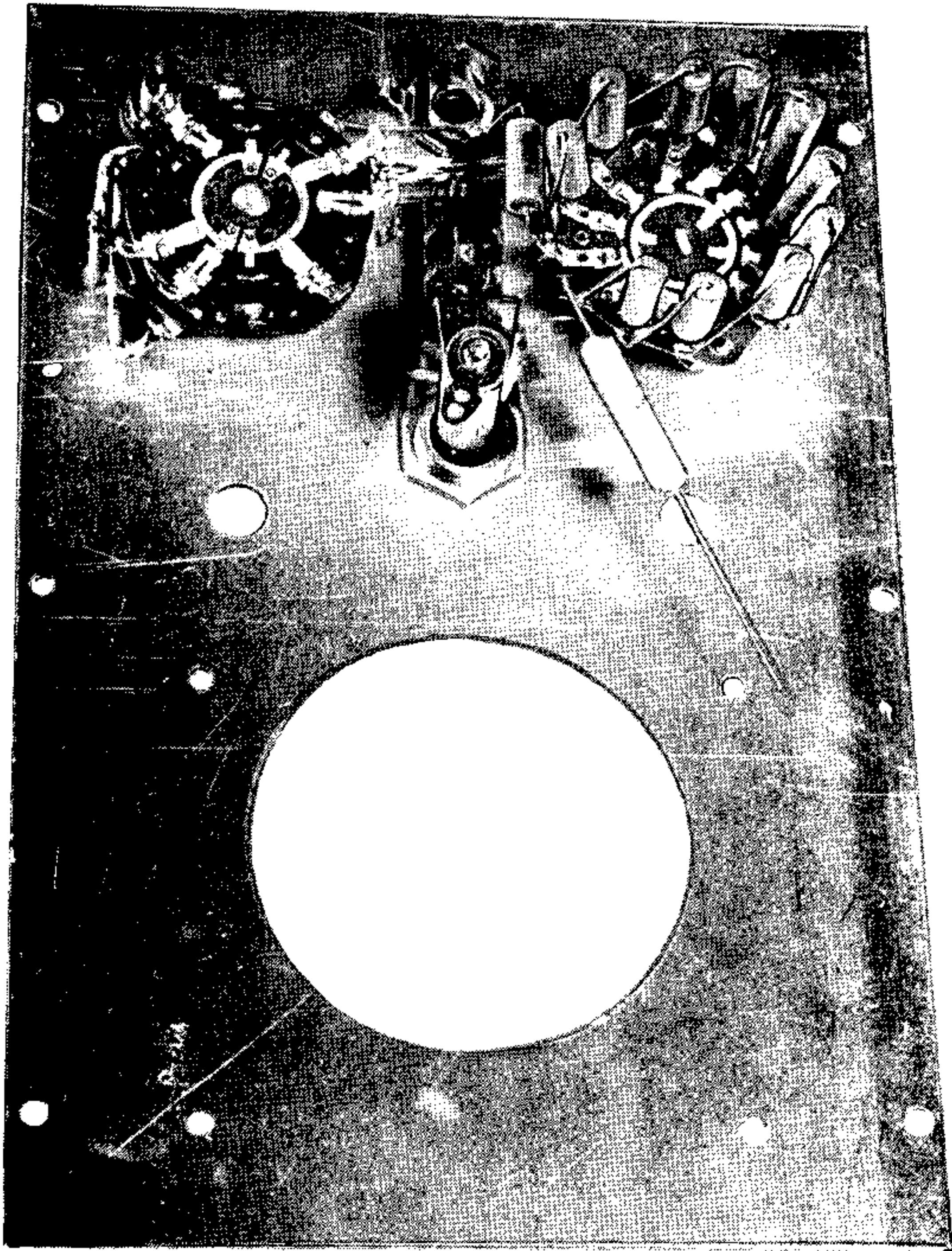

HEATHKIT  
VACUUM TUBE  
VOLTMETER  
MODEL V-4

11/11/49

V61B

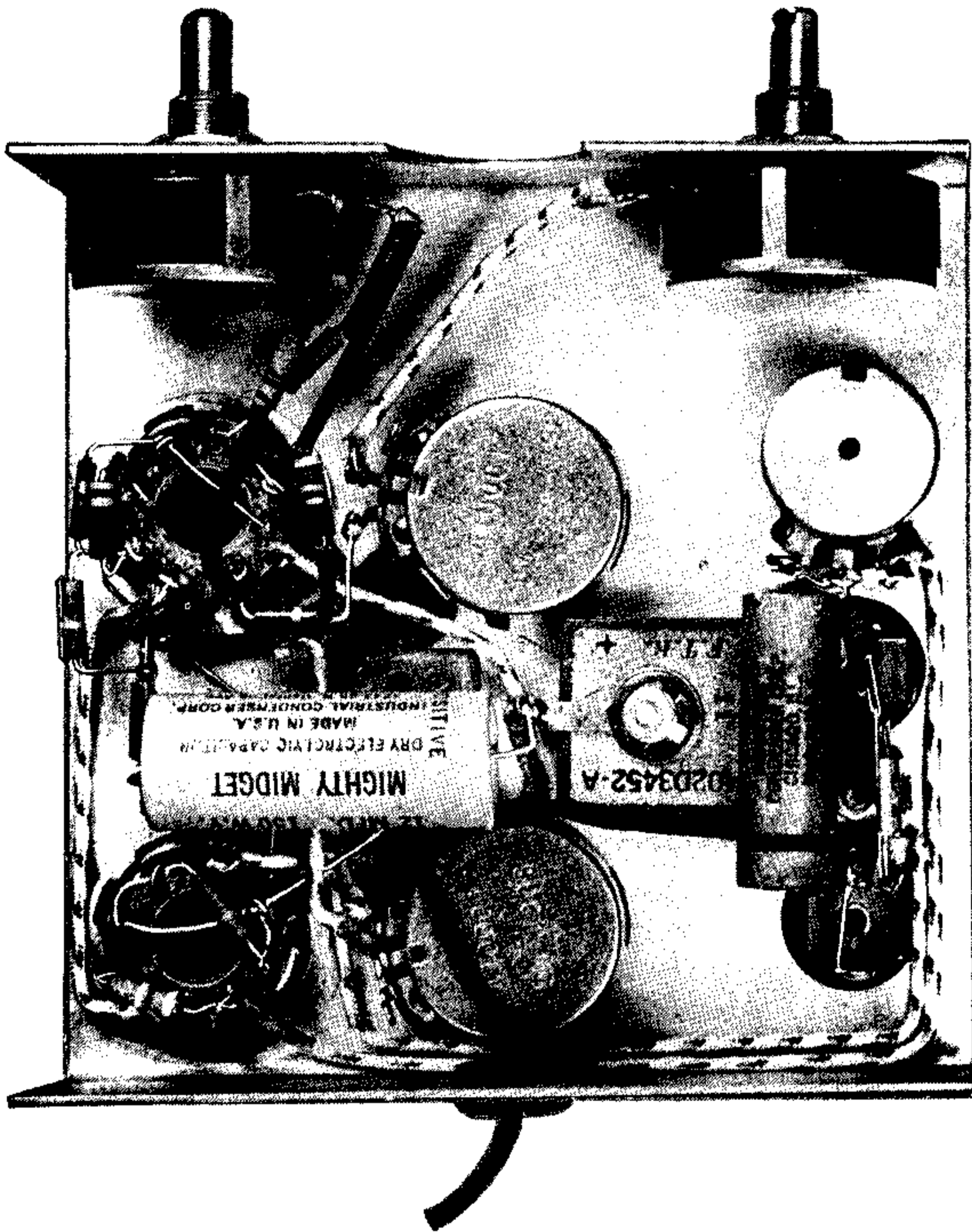

HEATHKIT  
VACUUM TUBE  
VOLTMETER  
MODEL V-4

11/11/49

V62C

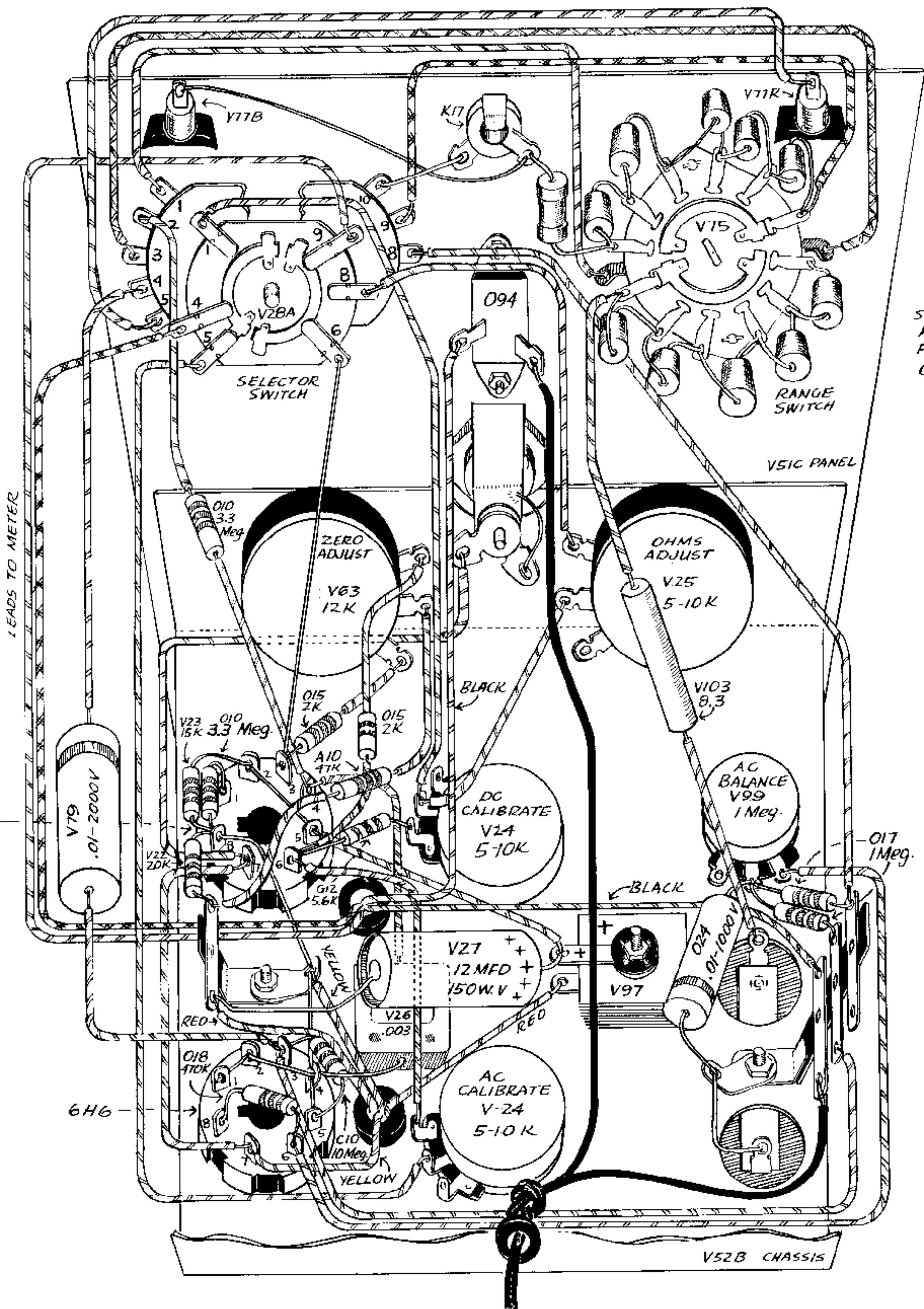

SEE DETAIL PICTORIAL FOR WIRING OF V75...

65N7

LEADS TO METER

HEATHKIT  
VACUUM TUBE  
VOLTMETER  
MODEL V-4

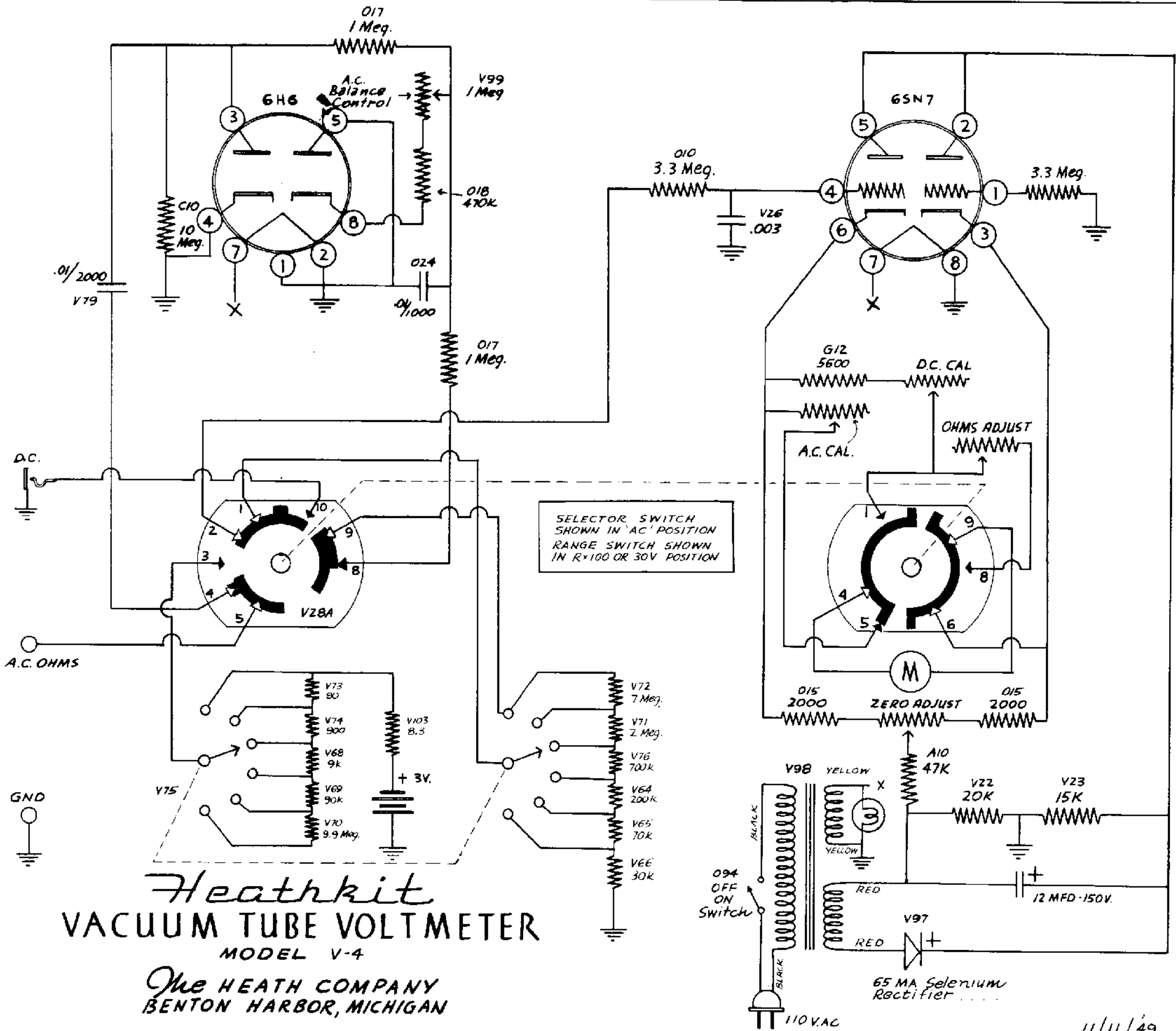

SELECTOR SWITCH  
SHOWN IN 'AC' POSITION  
RANGE SWITCH SHOWN  
IN R x 100 OR 30V POSITION

# Heathkit VACUUM TUBE VOLTMETER

MODEL V-4

The HEATH COMPANY  
BENTON HARBOR, MICHIGAN



WIRING OF EXPORT TYPE  
110/220 VOLT POWER  
TRANSFORMERS

These transformers have a dual primary for use on either 110 Volts or 220 Volts.  
Wire as shown.

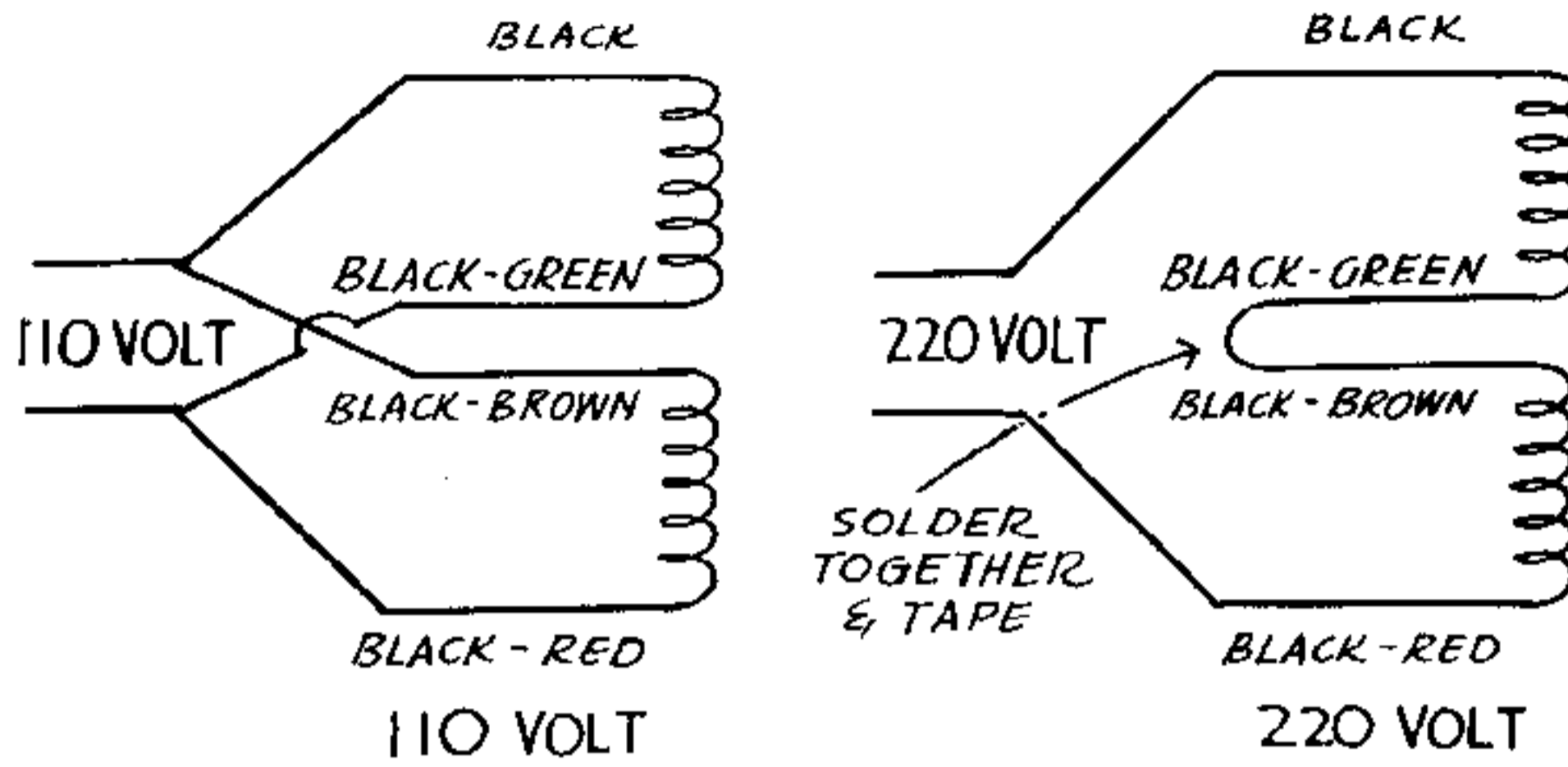

Notes